

# Antenna PowerGuard

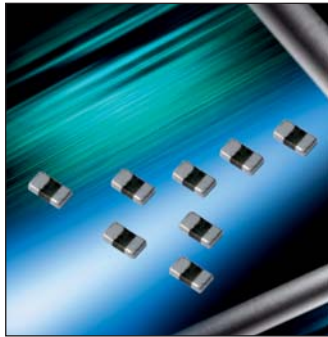

## AVX Low Capacitance Varistors

### ESD Protection for Circuits Sensitive to Capacitance



### GENERAL DESCRIPTION

AVX Antenna PowerGuard products are an ultra low capacitance extension of reliable AntennaGuard range with new voltage, capacitance and energy ratings. Designed for use in RF circuits, sensors, high-speed lines, optic circuits and capacitance sensitive applications.

The ability to handle larger transients makes the Antenna PowerGuard series useful in applications where capacitance sensitive circuit needs to be protected against higher energy and AEC-Q200 qualification allows for use in automotive applications.

These low capacitance values have low insertion loss, low leakage current and unsurpassed reliability compared to diode options. These advantages combined with size advantages and bi-directional protection make the Antenna PowerGuard the right choice for automotive and general applications, that are sensitive to capacitance.

### GENERAL CHARACTERISTICS

- Operating Temperature: -55°C to +125°C
- Case Size: 0402, 0603
- Working Voltage: 18 - 30Vdc
- Capacitance: 1.5 - 3.3pF
- Energy: 0.02 - 0.04J
- Peak Current: 1 - 3A

### FEATURES

- AEC-Q200 Qualified
- 25kV ESD rating
- Meet 48Vdc Jump Start requirements
- Multi-strike capability
- Sub 1nS response to ESD strike

### APPLICATIONS

- RF Circuit
- Sensors
- Antennas
- Data lines
- Radars
- Bluetooth
- Ethernet (IEEE 802.3bw and IEEE 802.3bp)
- VCAS06AP303R3LAT

### HOW TO ORDER

<b>VC</b> ↓ Varistor Chip	<b>AS</b> ↓ Series AS = Automotive	<b>06</b> ↓ Case Size 04 = 0402 06 = 0603	<b>AP</b> ↓ Type	<b>18</b> ↓ Working Voltage 18 = 18Vdc 24 = 24Vdc 30 = 30Vdc	<b>1R5</b> ↓ Capacitance 1R5 = 1.5pF 2R0 = 2.0pF 3R3 = 3.3pF	<b>D</b> ↓ Non-Std' Cap Tol D = ±0.5pF L = ±1.0pF	<b>A</b> ↓ N/A	<b>T</b> ↓ Termination T = Ni/Sn Plated	<b>1</b> ↓ Reel Size 1 = 7" reel* 3 = 13" reel* W = 7" reel**	<b>A</b> ↓ Reel Quantity A = 4K or 10K pcs (i.e.: 1A = 4,000 3A = 10,000 WA = 10,000
---------------------------------	---	---	------------------------	---	---	---	----------------------	--	--	--

\* for 0603  
\*\* for 0402 only

### PHYSICAL DIMENSIONS: mm (inches)

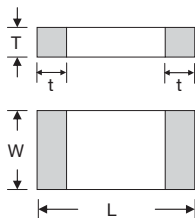

Size (EIA)	Length (L)	Width (W)	Max Thickness (T)	Land Length (t)
0402	1.00±0.10 (0.040±0.004)	0.50±0.10 (0.020±0.004)	0.60 (0.024)	0.25±0.15 (0.010±0.006)
0603	1.60±0.15 (0.063±0.006)	0.80±0.15 (0.031±0.006)	0.90 (0.035)	0.35±0.15 (0.014±0.006)



### ELECTRIAL CHARACTERISTICS

AVX Part Number	V <sub>w</sub> (DC)	V <sub>w</sub> (AC)	V <sub>B</sub>	V <sub>C</sub>	I <sub>L</sub>	E <sub>T</sub>	I <sub>P</sub>	Cap	Cap Tolerance	V <sub>Jump</sub>	Case Size
VCAS04AP181R5DAT	18	13	150-210	350	0.1	0.02	1	1.5	±0.5pF	48	0402
VCAS04AP182R0LAT	18	13	80-140	300	0.1	0.02	1	2.0	±1.0pF	48	0402
VCAS06AP182R0LAT	18	13	150-200	350	0.1	0.03	2	2.0	±1.0pF	48	0603
VCAS06AP243R3LAT	24	17	90-150	240	0.1	0.04	3	3.3	±1.0pF	48	0603
VCAS04AP301R5DAT	30	21	150-210	350	0.1	0.02	1	1.5	±0.5pF	48	0402
VCAS06AP302R0LAT	30	21	150-200	350	0.1	0.03	2	2.0	±1.0pF	48	0603
VCAS06AP303R3LAT	30	21	90-150	240	0.1	0.04	3	3.3	±1.0pF	48	0603

V<sub>w</sub>(DC) DC Working Voltage [V]  
V<sub>w</sub>(AC) AC Working Voltage [V]  
V<sub>B</sub> Breakdown Voltage [V @ 1mA<sub>DC</sub>]  
V<sub>C</sub> Clamping Voltage [V @ 1A]  
I<sub>L</sub> Maximum leakage current at the working voltage [μA]

E<sub>T</sub> Transient Energy Rating [J, 10x1000μS]  
I<sub>P</sub> Peak Current Rating [A, 8x20μS]  
Cap Capacitance [pF] @ 1MHz specified and 0.5V<sub>RMS</sub>  
Cap Tol Capacitance tolerance (pF) from Typ value  
V<sub>Jump</sub> Jump Start (V, 5min)



# Antenna PowerGuard



## AVX Low Capacitance Varistors ESD Protection for Circuits Sensitive to Capacitance

### V/I CHARACTERISTICS

### S21 CHARACTERISTICS

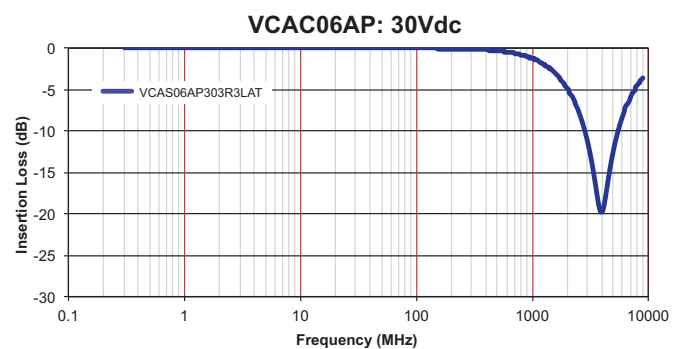
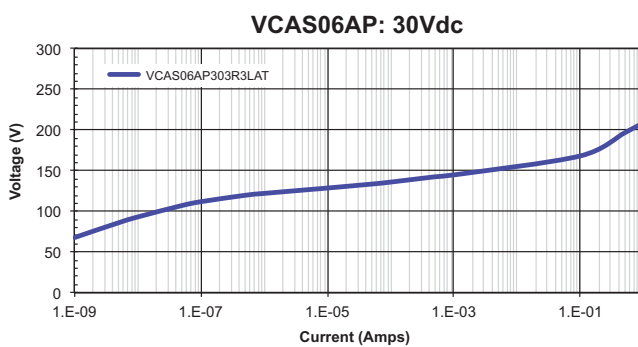
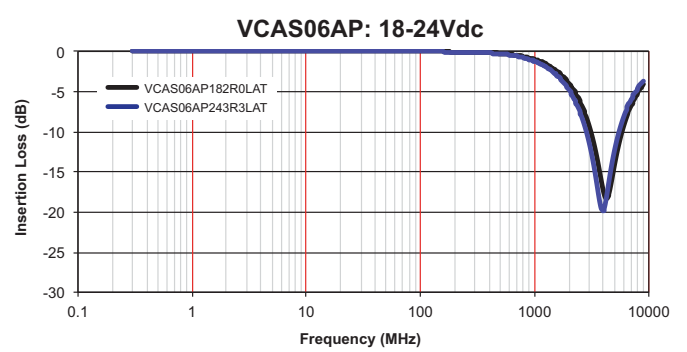
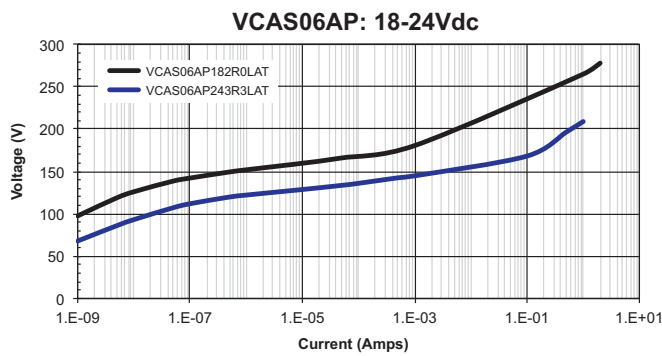
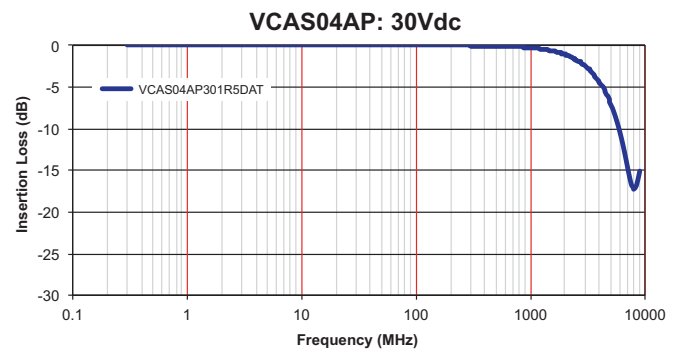
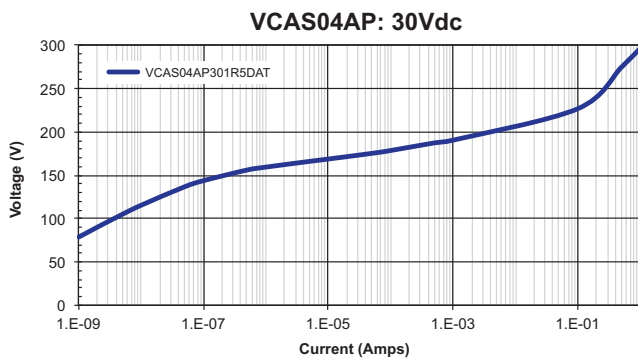
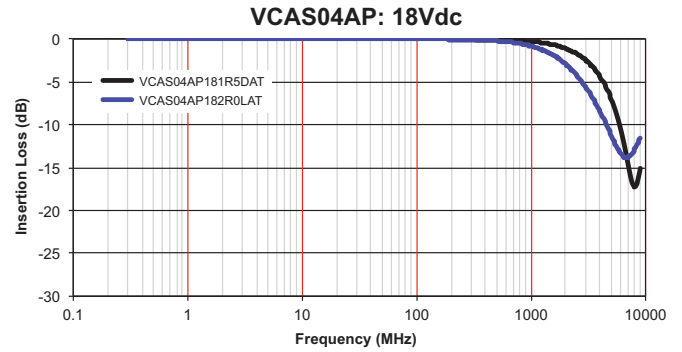
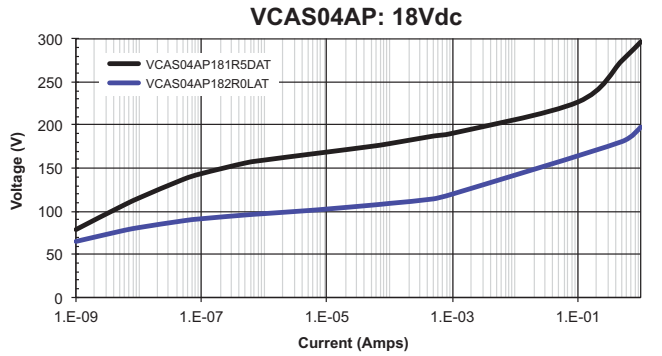

# Antenna PowerGuard



## AVX Low Capacitance Varistors

### ESD Protection for Circuits Sensitive to Capacitance

#### ESD CHARACTERISTICS

8kV ESD Vc Wave Capture  
(150pF/330ohm Network)

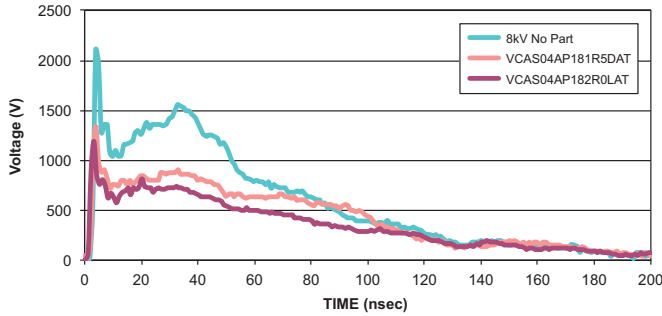

8kV ESD Vc Wave Capture  
(150pF/330ohm Network)

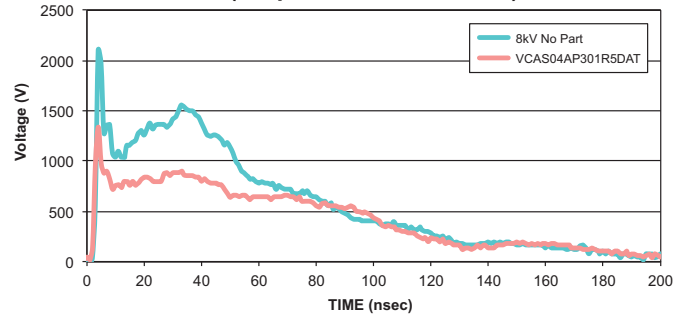

15kV ESD Vc Wave Capture  
(150pF/330ohm Network)

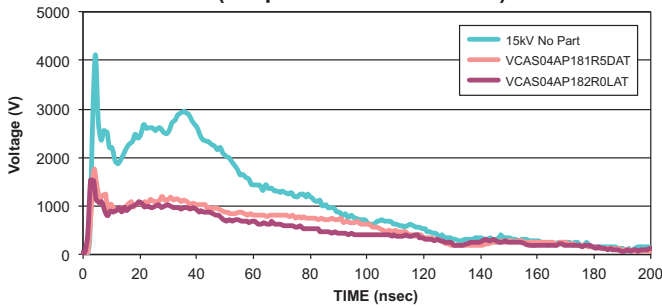

15kV ESD Vc Wave Capture  
(150pF/330ohm Network)

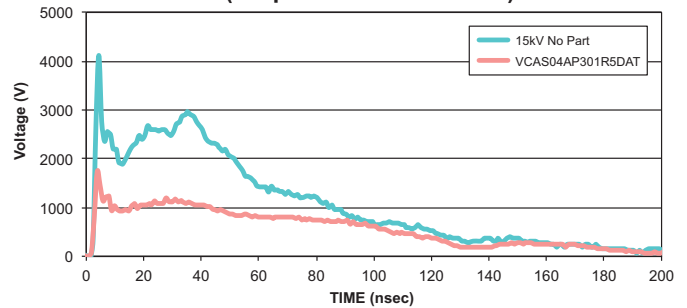

8kV ESD Vc Wave Capture  
(150pF/330ohm Network)

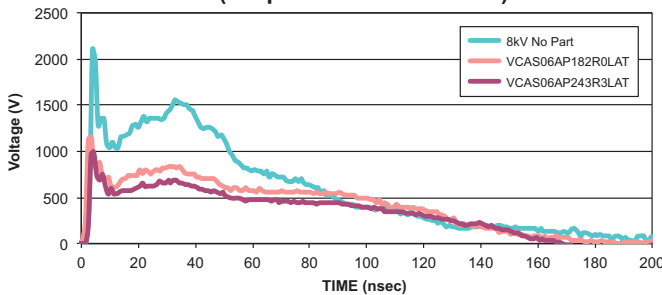

8kV ESD Vc Wave Capture  
(150pF/330ohm Network)

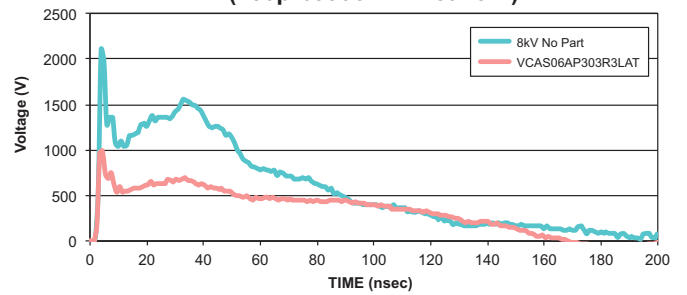

15kV ESD Vc Wave Capture  
(150pF/330ohm Network)

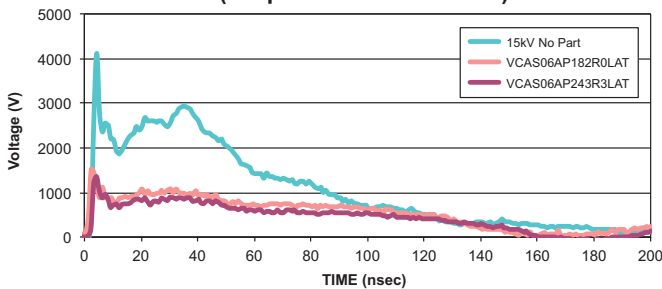

15kV ESD Vc Wave Capture  
(150pF/330ohm Network)

