

## 0.05 to 3.0 GHz SPDT SWITCH

### DESCRIPTION

The μPG2408TK is a GaAs MMIC for L, S-band SPDT (Single Pole Double Throw) switch for 2.4 GHz wireless LAN, mobile phone and other L, S-band applications.

This device operates with dual control switching voltages of 2.5 to 5.3 V. This device can operate at frequencies from 0.05 to 3.0 GHz, with low insertion loss and high isolation.

This device is housed in a 6-pin lead-less minimold package (1511 PKG) and is suitable for high-density surface mounting.

### FEATURES

- Switch control voltage :  $V_{cont(H)} = 3.0\text{ V TYP.}$   
:  $V_{cont(L)} = 0\text{ V TYP.}$
- Low insertion loss :  $L_{ins} = 0.40\text{ dB TYP. @ } f = 1.0\text{ GHz}$   
:  $L_{ins} = 0.50\text{ dB TYP. @ } f = 2.5\text{ GHz}$
- High isolation :  $ISL = 27\text{ dB TYP. @ } f = 1.0\text{ GHz}$   
:  $ISL = 18\text{ dB TYP. @ } f = 2.5\text{ GHz}$
- Handling power :  $P_{in(0.1\text{ dB})} = +29.0\text{ dBm TYP. @ } f = 0.5\text{ to } 3.0\text{ GHz}$
- High-density surface mounting : 6-pin lead-less minimold package (1.5 × 1.1 × 0.55 mm)

### APPLICATIONS

- L, S-band digital cellular or cordless telephone
- W-LAN, WLL and Bluetooth™ etc.

### ORDERING INFORMATION

Part Number	Order Number	Package	Marking	Supplying Form
μPG2408TK-E2	μPG2408TK-E2-A	6-pin lead-less minimold (1511 PKG) (Pb-Free)	G5X	<ul style="list-style-type: none"> <li>• Embossed tape 8 mm wide</li> <li>• Pin 1, 6 face the perforation side of the tape</li> <li>• Qty 5 kpcs/reel</li> </ul>

**Remark** To order evaluation samples, please contact your nearby sales office.

Part number for sample order: μPG2408TK-A

**Caution** Although this device is designed to be as robust as possible, ESD (Electrostatic Discharge) can damage this device. This device must be protected at all times from ESD. Static charges may easily produce potentials of several kilovolts on the human body or equipment, which can discharge without detection. Industry-standard ESD precautions must be employed at all times.

The information in this document is subject to change without notice. Before using this document, please confirm that this is the latest version.

**PIN CONNECTIONS AND INTERNAL BLOCK DIAGRAM**

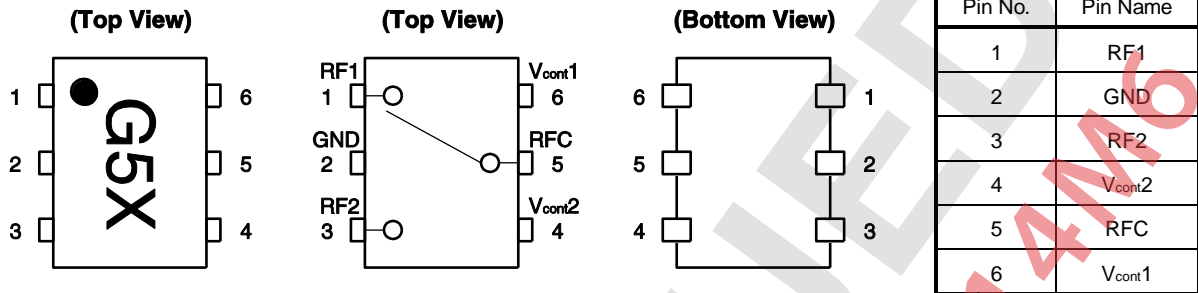

**SW TRUTH TABLE**

ON Path	V <sub>cont1</sub>	V <sub>cont2</sub>
RFC-RF1	Low	High
RFC-RF2	High	Low

**ABSOLUTE MAXIMUM RATINGS (T<sub>A</sub> = +25°C, unless otherwise specified)**

Parameter	Symbol	Ratings	Unit
Switch Control Voltage	V <sub>cont</sub>	+6.0 <sup>Note</sup>	V
Input Power	P <sub>in</sub>	+33.0	dBm
Operating Ambient Temperature	T <sub>A</sub>	-45 to +85	°C
Storage Temperature	T <sub>stg</sub>	-55 to +150	°C

**Note** |V<sub>cont1</sub> - V<sub>cont2</sub>| ≤ 6.0 V

**RECOMMENDED OPERATING RANGE (T<sub>A</sub> = +25°C, unless otherwise specified)**

Parameter	Symbol	MIN.	TYP.	MAX.	Unit
Operating Frequency	f	0.05	-	3.0	GHz
Switch Control Voltage (H)	V <sub>cont (H)</sub>	2.5	3.0	5.3	V
Switch Control Voltage (L)	V <sub>cont (L)</sub>	-0.2	0	0.2	V
Control Voltage Difference	ΔV <sub>cont (H)</sub> , ΔV <sub>cont (L)</sub> <sup>Note</sup>	-0.1	0	0.1	V

**Note** ΔV<sub>cont (H)</sub> = V<sub>cont1 (H)</sub> - V<sub>cont2 (H)</sub>  
 ΔV<sub>cont (L)</sub> = V<sub>cont1 (L)</sub> - V<sub>cont2 (L)</sub>

**ELECTRICAL CHARACTERISTICS**

(T<sub>A</sub> = +25°C, V<sub>cont</sub> (H) = 3.0 V, V<sub>cont</sub> (L) = 0 V, DC blocking capacitors = 56 pF, unless otherwise specified)

Parameter	Symbol	Test Conditions	MIN.	TYP.	MAX.	Unit
Insertion Loss 1	L <sub>ins1</sub>	f = 0.05 to 0.5 GHz <sup>Note 1</sup>	–	0.40	0.55	dB
Insertion Loss 2	L <sub>ins2</sub>	f = 0.5 to 1.0 GHz	–	0.40	0.55	dB
Insertion Loss 3	L <sub>ins3</sub>	f = 1.0 to 2.0 GHz	–	0.48	0.63	dB
Insertion Loss 4	L <sub>ins4</sub>	f = 2.0 to 2.5 GHz	–	0.50	0.65	dB
Insertion Loss 5	L <sub>ins5</sub>	f = 2.5 to 3.0 GHz	–	0.56	0.70	dB
Isolation 1	ISL1	f = 0.05 to 0.5 GHz <sup>Note 1</sup>	24	27	–	dB
Isolation 2	ISL2	f = 0.5 to 1.0 GHz	24	27	–	dB
Isolation 3	ISL3	f = 1.0 to 2.0 GHz	16	19	–	dB
Isolation 4	ISL4	f = 2.0 to 2.5 GHz	15	18	–	dB
Isolation 5	ISL5	f = 2.5 to 3.0 GHz	14	17	–	dB
Input Return Loss 1	RL <sub>in1</sub>	f = 0.05 to 0.5 GHz <sup>Note 1</sup>	15	20	–	dB
Input Return Loss 2	RL <sub>in2</sub>	f = 0.5 to 3.0 GHz	15	20	–	dB
Output Return Loss 1	RL <sub>out1</sub>	f = 0.05 to 0.5 GHz <sup>Note 1</sup>	15	20	–	dB
Output Return Loss 2	RL <sub>out2</sub>	f = 0.5 to 3.0 GHz	15	20	–	dB
0.1 dB Loss Compression	P <sub>in (0.1 dB)</sub>	f = 2.0/2.5 GHz	+27.0	+29.0	–	dBm
Input Power <sup>Note 2</sup>		f = 0.5 to 3.0 GHz	–	+29.0	–	dBm
Input 3rd Order Intercept Point	IIP <sub>3</sub>	f = 0.5 to 3.0 GHz, 2 tone, 5 MHz spacing	–	+60	–	dBm
Switch Control Current	I <sub>cont</sub>	No RF input	–	0.3	20	μA
Switch Control Speed	t <sub>sw</sub>	50% CTL to 90%/10% RF	–	50	500	ns

**Notes 1.** DC blocking capacitors = 1 000 pF at f = 0.05 to 0.5 GHz

**2.** P<sub>in (0.1 dB)</sub> is the measured input power level when the insertion loss increases 0.1 dB more than that of linear range.

**Caution** It is necessary to use DC blocking capacitors with this device.

The value of DC blocking capacitors should be chosen to accommodate the frequency of operation, bandwidth, switching speed and the condition with actual board of your system. The range of recommended DC blocking capacitor value is less than 100 pF for frequencies above 0.5 GHz, and 1 000pF for frequencies above 0.5 GHz.

EVALUATION CIRCUIT

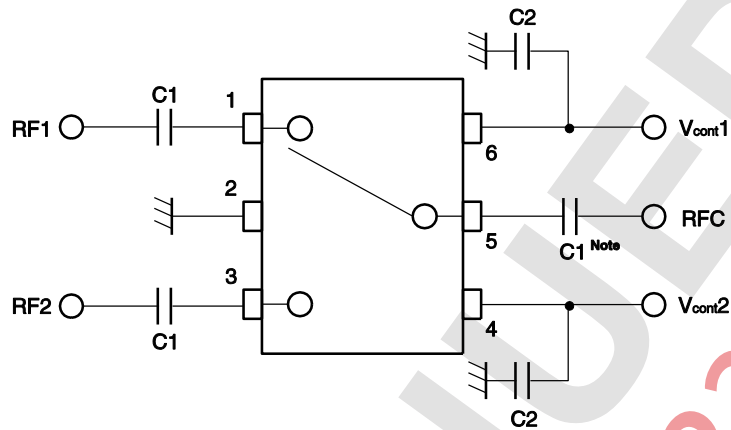

**Note** C1 : 0.05 to 0.5 GHz 1 000 pF  
 : 0.5 to 3.0 GHz 56 pF  
 C2 : 1 000 pF

The application circuits and their parameters are for reference only and are not intended for use in actual design-ins.

APPLICATION INFORMATION

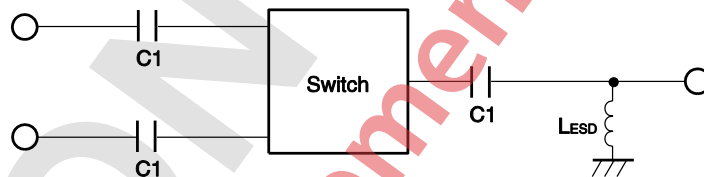

- LESD provides a means to increase the ESD protection on a specific RF port, typically the port attached to the antenna.
- The value may be tailored to provide specific electrical responses.
- The RF ground connections should be kept as short as possible and connected to directly to a good RF ground for best performance.

ILLUSTRATION OF THE TEST CIRCUIT ASSEMBLED ON EVALUATION BOARD

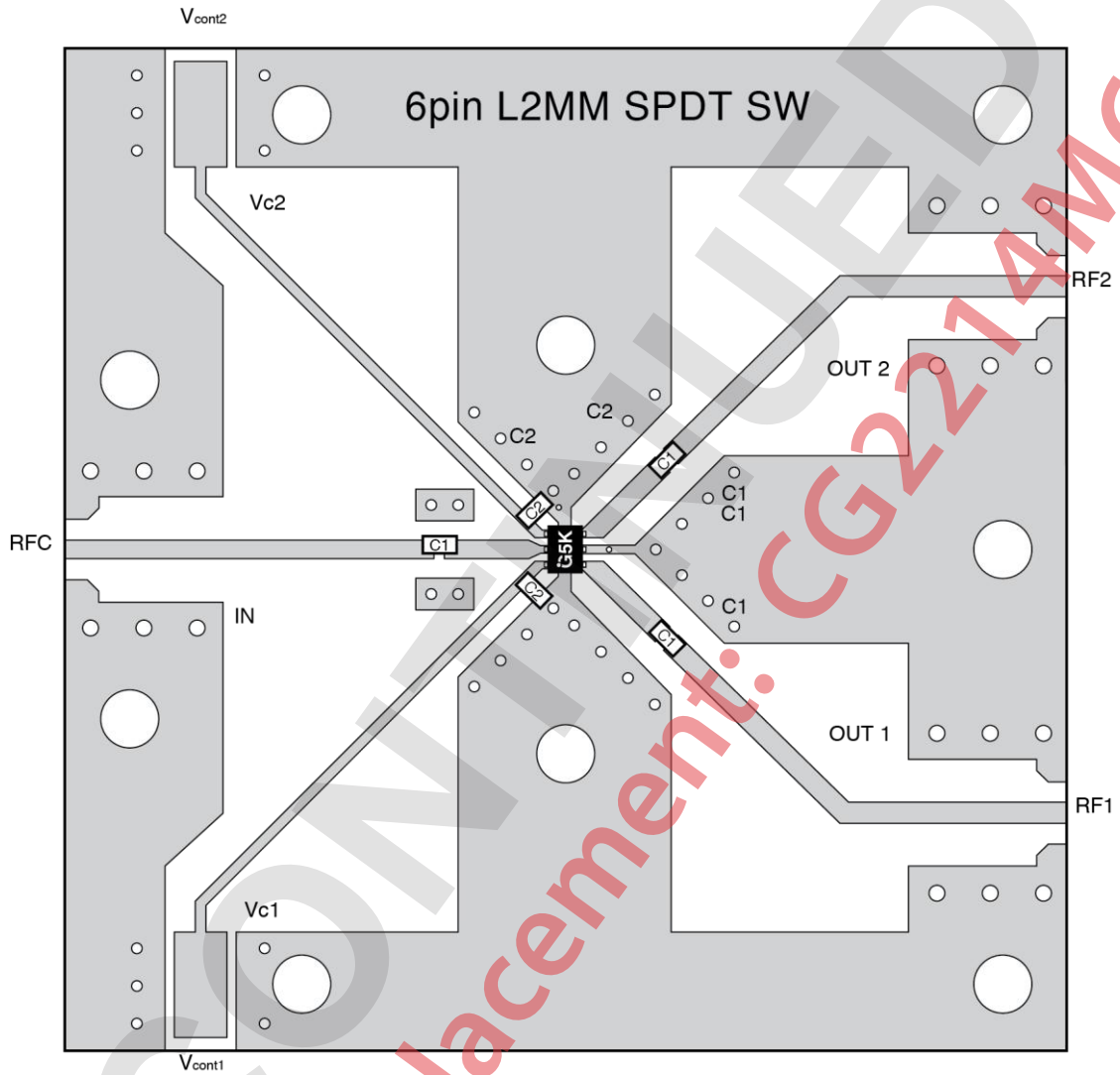

USING THE EVALUATION BOARD

Symbol	Test Conditions	Values
C1	f = 0.05 to 0.5 GHz	1 000 pF
	f = 0.5 to 3.0 GHz	56 pF
C2		1 000 pF

TYPICAL CHARACTERISTICS ( $T_A = +25^\circ\text{C}$ , DC blocking capacitors = 56 pF, unless otherwise specified)

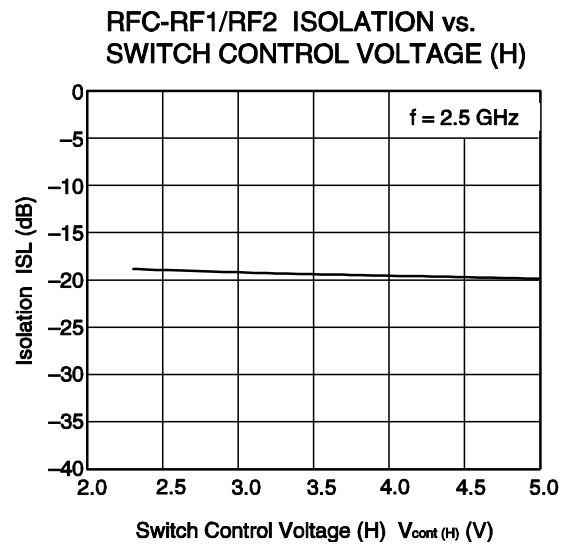
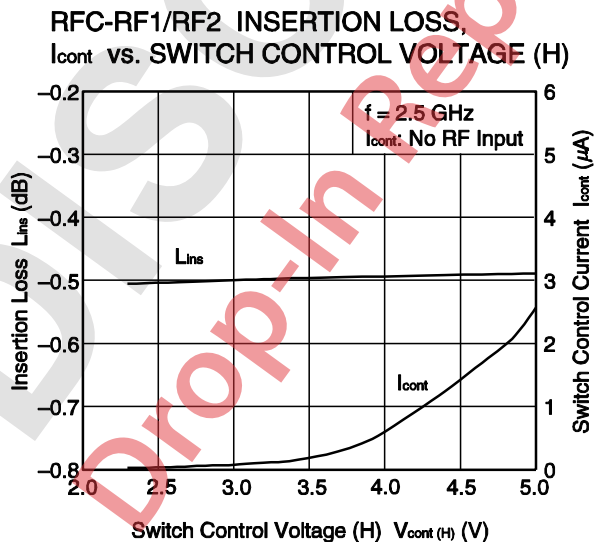
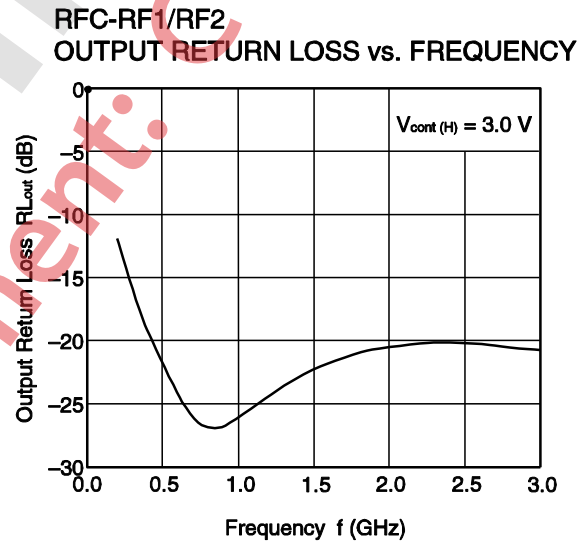
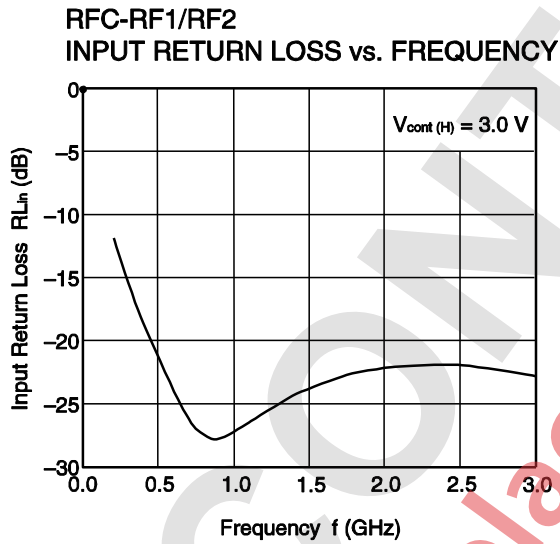
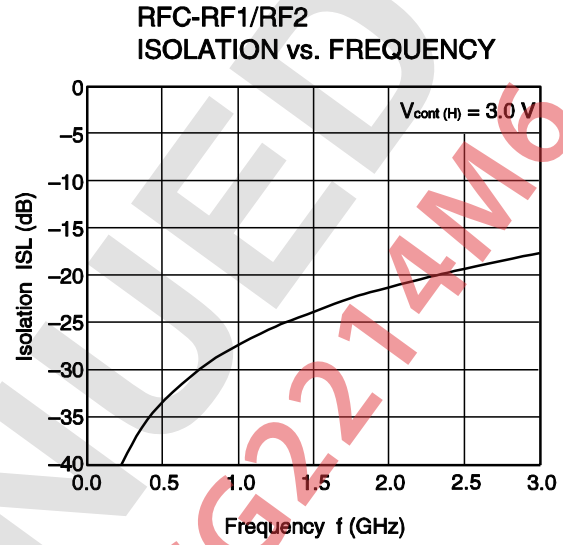
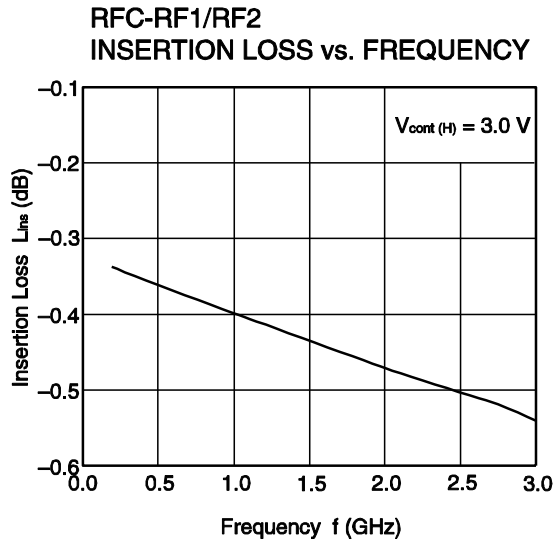

Remark The graphs indicate nominal characteristics.

RFC-RF1/RF2 INPUT RETURN LOSS vs. SWITCH CONTROL VOLTAGE (H)

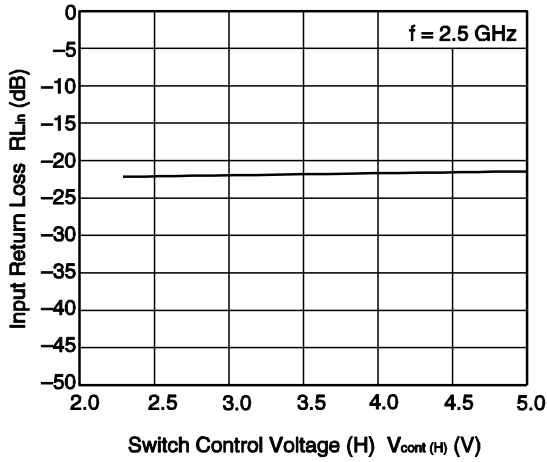

RFC-RF1/RF2 OUTPUT RETURN LOSS vs. SWITCH CONTROL VOLTAGE (H)

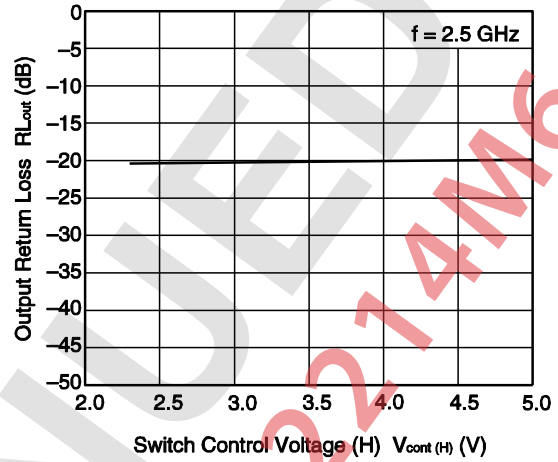

RFC-RF1/RF2  $P_{in(0.1dB)}$  vs. SWITCH CONTROL VOLTAGE (H)

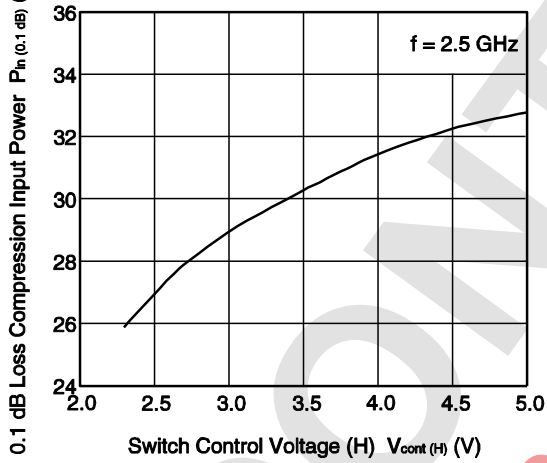

RFC-RF1/RF2 INSERTION LOSS,  $I_{cont}$  vs. INPUT POWER

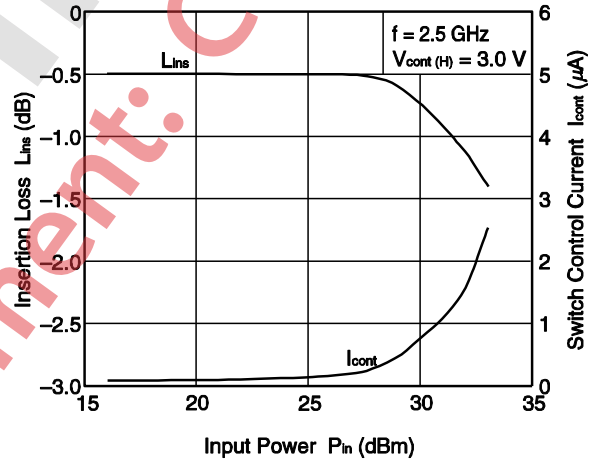

RFC-RF1/RF2  $P_{in(0.1dB)}$  vs. FREQUENCY

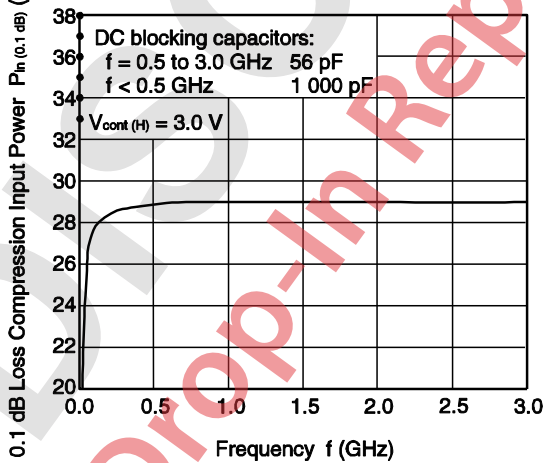

Remark: The graphs indicate nominal characteristics.

**MOUNTING PAD LAYOUT DIMENSIONS**

**6-PIN LEAD-LESS MINIMOLD (1511 PKG) (UNIT: mm)**

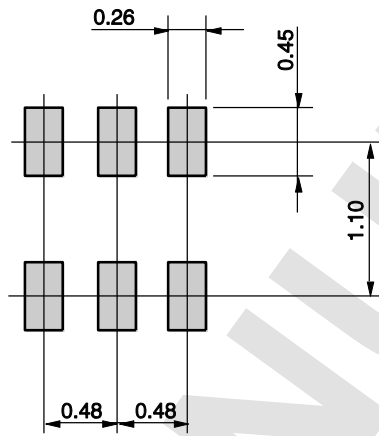

**Remark** The mounting pad layout in this document is for reference only. When designing PCB, please consider workability of mounting, solder joint reliability, prevention of solder bridge and so on, in order to optimize the design.



PACKAGE DIMENSIONS

6-PIN LEAD-LESS MINIMOLD (1511 PKG) (UNIT: mm)

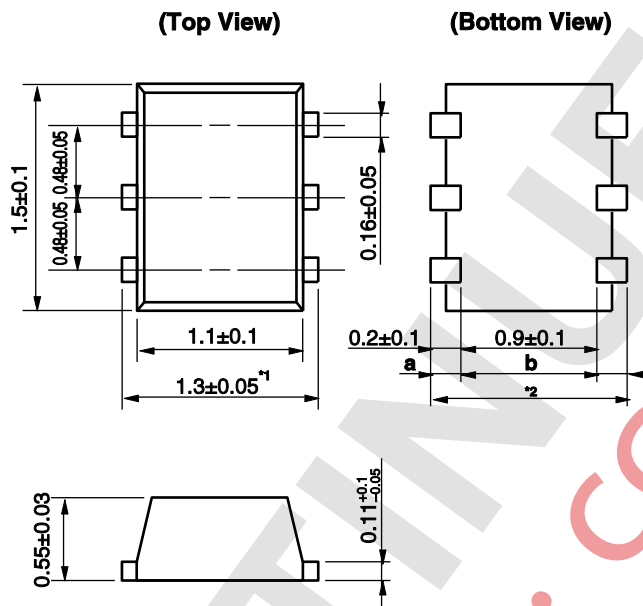

**Remark** Dimension<sup>1</sup> is bigger than dimension<sup>2</sup> (dimension<sup>2</sup> = a + b + c).

**RECOMMENDED SOLDERING CONDITIONS**

This product should be soldered and mounted under the following recommended conditions. For soldering methods and conditions other than those recommended below, contact your nearby sales office.

Soldering Method	Soldering Conditions	Condition Symbol
Infrared Reflow	Peak temperature (package surface temperature) : 260°C or below Time at peak temperature : 10 seconds or less Time at temperature of 220°C or higher : 60 seconds or less Preheating time at 120 to 180°C : 120±30 seconds Maximum number of reflow processes : 3 times Maximum chlorine content of rosin flux (% mass) : 0.2%(Wt.) or below	IR260
Wave Soldering	Peak temperature (molten solder temperature) : 260°C or below Time at peak temperature : 10 seconds or less Preheating temperature (package surface temperature) : 120°C or below Maximum number of flow processes : 1 time Maximum chlorine content of rosin flux (% mass) : 0.2%(Wt.) or below	WS260
Partial Heating	Peak temperature (terminal temperature) : 350°C or below Soldering time (per side of device) : 3 seconds or less Maximum chlorine content of rosin flux (% mass) : 0.2%(Wt.) or below	HS350

**Caution Do not use different soldering methods together (except for partial heating).**

<p><b>Caution</b></p>	<p>GaAs Products</p>	<p>This product uses gallium arsenide (GaAs). GaAs vapor and powder are hazardous to human health if inhaled or ingested, so please observe the following points.</p> <ul style="list-style-type: none"> <li>• Follow related laws and ordinances when disposing of the product. If there are no applicable laws and/or ordinances, dispose of the product as recommended below.</li> <li>1. Commission a disposal company able to (with a license to) collect, transport and dispose of materials that contain arsenic and other such industrial waste materials.</li> <li>2. Exclude the product from general industrial waste and household garbage, and ensure that the product is controlled (as industrial waste subject to special control) up until final disposal.</li> <li>• Do not burn, destroy, cut, crush, or chemically dissolve the product.</li> <li>• Do not lick the product or in any way allow it to enter the mouth.</li> </ul>
-----------------------	----------------------	---

DISCONTINUING

Drop-In Replacement: CG2214M6

## NOTICE

1. Descriptions of circuits, software and other related information in this document are provided only to illustrate the operation of semiconductor products and application examples. You are fully responsible for the incorporation of these circuits, software, and information in the design of your equipment. California Eastern Laboratories and Renesas Electronics assumes no responsibility for any losses incurred by you or third parties arising from the use of these circuits, software, or information.
2. California Eastern Laboratories has used reasonable care in preparing the information included in this document, but California Eastern Laboratories does not warrant that such information is error free. California Eastern Laboratories and Renesas Electronics assumes no liability whatsoever for any damages incurred by you resulting from errors in or omissions from the information included herein.
3. California Eastern Laboratories and Renesas Electronics do not assume any liability for infringement of patents, copyrights, or other intellectual property rights of third parties by or arising from the use of Renesas Electronics products or technical information described in this document. No license, express, implied or otherwise, is granted hereby under any patents, copyrights or other intellectual property rights of California Eastern Laboratories or Renesas Electronics or others.
4. You should not alter, modify, copy, or otherwise misappropriate any Renesas Electronics product, whether in whole or in part. California Eastern Laboratories and Renesas Electronics assume no responsibility for any losses incurred by you or third parties arising from such alteration, modification, copy or otherwise misappropriation of Renesas Electronics product.
5. Renesas Electronics products are classified according to the following two quality grades: "Standard" and "High Quality". The recommended applications for each Renesas Electronics product depends on the product's quality grade, as indicated below. "Standard": Computers; office equipment; communications equipment; test and measurement equipment; audio and visual equipment; home electronic appliances; machine tools; personal electronic equipment; and industrial robots etc. "High Quality": Transportation equipment (automobiles, trains, ships, etc.); traffic control systems; anti-disaster systems; anti-crime systems; and safety equipment etc. Renesas Electronics products are neither intended nor authorized for use in products or systems that may pose a direct threat to human life or bodily injury (artificial life support devices or systems, surgical implantations etc.), or may cause serious property damages (nuclear reactor control systems, military equipment etc.). You must check the quality grade of each Renesas Electronics product before using it in a particular application. You may not use any Renesas Electronics product for any application for which it is not intended. California Eastern Laboratories and Renesas Electronics shall not be in any way liable for any damages or losses incurred by you or third parties arising from the use of any Renesas Electronics product for which the product is not intended by California Eastern Laboratories or Renesas Electronics.
6. You should use the Renesas Electronics products described in this document within the range specified by California Eastern Laboratories, especially with respect to the maximum rating, operating supply voltage range, movement power voltage range, heat radiation characteristics, installation and other product characteristics. California Eastern Laboratories shall have no liability for malfunctions or damages arising out of the use of Renesas Electronics products beyond such specified ranges.
7. Although Renesas Electronics endeavors to improve the quality and reliability of its products, semiconductor products have specific characteristics such as the occurrence of failure at a certain rate and malfunctions under certain use conditions. Further, Renesas Electronics products are not subject to radiation resistance design. Please be sure to implement safety measures to guard them against the possibility of physical injury, and injury or damage caused by fire in the event of the failure of a Renesas Electronics product, such as safety design for hardware and software including but not limited to redundancy, fire control and malfunction prevention, appropriate treatment for aging degradation or any other appropriate measures. Because the evaluation of microcomputer software alone is very difficult, please evaluate the safety of the final products or systems manufactured by you.
8. Please contact a California Eastern Laboratories sales office for details as to environmental matters such as the environmental compatibility of each Renesas Electronics product. Please use Renesas Electronics products in compliance with all applicable laws and regulations that regulate the inclusion or use of controlled substances, including without limitation, the EU RoHS Directive. California Eastern Laboratories and Renesas Electronics assume no liability for damages or losses occurring as a result of your noncompliance with applicable laws and regulations.
9. Renesas Electronics products and technology may not be used for or incorporated into any products or systems whose manufacture, use, or sale is prohibited under any applicable domestic or foreign laws or regulations. You should not use Renesas Electronics products or technology described in this document for any purpose relating to military applications or use by the military, including but not limited to the development of weapons of mass destruction. When exporting the Renesas Electronics products or technology described in this document, you should comply with the applicable export control laws and regulations and follow the procedures required by such laws and regulations.
10. It is the responsibility of the buyer or distributor of California Eastern Laboratories, who distributes, disposes of, or otherwise places the Renesas Electronics product with a third party, to notify such third party in advance of the contents and conditions set forth in this document, California Eastern Laboratories and Renesas Electronics assume no responsibility for any losses incurred by you or third parties as a result of unauthorized use of Renesas Electronics products.
11. This document may not be reproduced or duplicated in any form, in whole or in part, without prior written consent of California Eastern Laboratories.
12. Please contact a California Eastern Laboratories sales office if you have any questions regarding the information contained in this document or Renesas Electronics products, or if you have any other inquiries.

**NOTE 1:** "Renesas Electronics" as used in this document means Renesas Electronics Corporation and also includes its majority-owned subsidiaries.

**NOTE 2:** "Renesas Electronics product(s)" means any product developed or manufactured by or for Renesas Electronics.

**NOTE 3:** Products and product information are subject to change without notice.

**CEL Headquarters** • 4590 Patrick Henry Drive, Santa Clara, CA 95054 • Phone (408) 919-2500 • [www.cel.com](http://www.cel.com)

For a complete list of sales offices, representatives and distributors,  
Please visit our website: [www.cel.com/contactus](http://www.cel.com/contactus)