

**SILICON MMIC LOW CURRENT AMPLIFIER
 FOR MOBILE COMMUNICATIONS**
DESCRIPTION

The IPC8178TK is a silicon monolithic integrated circuit designed as amplifier for mobile communications. This IC can realize low current consumption with external chip inductor which can not be realized on internal 50 K wide band matched IC. IPC8178TK adopts 6-pin lead-less minimold package using same chip as the conventional IPC8178TB in 6-pin super minimold.

TK suffix IC which is smaller package than TB suffix IC contributes to reduce mounting space by 50 %.

This IC is manufactured using our 30 GHz f_{max} UHS0 (Ultra High Speed Process) silicon bipolar process.

FEATURES

- Low current consumption : $I_{CC} = 1.9 \text{ mA TYP. @ } V_{CC} = 3.0 \text{ V}$
- Supply voltage : $V_{CC} = 2.4 \text{ to } 3.3 \text{ V}$
- Excellent isolation : $ISL = 40 \text{ dB TYP. @ } f = 1.0 \text{ GHz}$
 $ISL = 41 \text{ dB TYP. @ } f = 1.9 \text{ GHz}$
 $ISL = 42 \text{ dB TYP. @ } f = 2.4 \text{ GHz}$
- Power gain : $G_P = 11.0 \text{ dB TYP. @ } f = 1.0 \text{ GHz}$
 $G_P = 11.0 \text{ dB TYP. @ } f = 1.9 \text{ GHz}$
 $G_P = 11.0 \text{ dB TYP. @ } f = 2.4 \text{ GHz}$
- Gain 1 dB compression output power : $P_{O(1 \text{ dB})} = \Phi 5.5 \text{ dBm TYP. @ } f = 1.0 \text{ GHz}$
 $P_{O(1 \text{ dB})} = \Phi 8.0 \text{ dBm TYP. @ } f = 1.9 \text{ GHz}$
 $P_{O(1 \text{ dB})} = \Phi 8.0 \text{ dBm TYP. @ } f = 2.4 \text{ GHz}$
- Operating frequency : 0.1 to 2.4 GHz (Output port LC matching)
- High-density surface mounting : 6-pin lead-less minimold package (1.5 X 1.3 X 0.55 mm)
- Light weight : 3 mg (Standard value)

APPLICAION

- Buffer amplifiers on 0.1 to 2.4 GHz mobile communications system

Caution Observe precautions when handling because these devices are sensitive to electrostatic discharge.

★ **ORDERING INFORMATION**

Part Number	Order Number	Package	Marking	Supplying Form
μPC8178TK-E2	μPC8178TK-E2-A	6-pin lead-less minimold (1511) (Pb-Free) ^{Note}	6B	<ul style="list-style-type: none"> • Embossed tape 8 mm wide • Pin 1, 2, 3 face the perforation side of the tape • Qty 5 kpcs/reel

Note With regards to terminal solder (the solder contains lead) plated products (conventionally plated), contact your nearby sales office.

Remark To order evaluation samples, contact your nearby sales office.
Part number for sample order: μPC8178TK-A

PRODUCT LINE-UP (T_A = +25°C, V_{CC} = V_{out} = 3.0 V, Z_S = Z_L = 50 Ω)

Parameter Part No.	I _{CC} (mA)	1.0 GHz output port matching frequency			1.66 GHz output port matching frequency			1.9 GHz output port matching frequency			2.4 GHz output port matching frequency			Marking
		G _P (dB)	ISL (dB)	P _{O(1dB)} (dBm)	G _P (dB)	ISL (dB)	P _{O(1dB)} (dBm)	G _P (dB)	ISL (dB)	P _{O(1dB)} (dBm)	G _P (dB)	ISL (dB)	P _{O(1dB)} (dBm)	
μPC8178TB	1.9	11.0	39.0	-4.0	-	-	-	11.5	40.0	-7.0	11.5	38.0	-7.5	C3B
μPC8178TK	1.9	11.0	40.0	-5.5	-	-	-	11.0	41.0	-8.0	11.0	42.0	-8.0	6B
μPC8179TB	4.0	13.5	44.0	+3.0	-	-	-	15.5	42.0	+1.5	15.5	41.0	+1.0	C3C
μPC8128TB	2.8	12.5	39.0	-4.0	13.0	39.0	-4.0	13.0	37.0	-4.0	-	-	-	C2P
μPC8151TB	4.2	12.5	38.0	+2.5	15.0	36.0	+1.5	15.0	34.0	+0.5	-	-	-	C2U
μPC8152TB	5.6	23.0	40.0	-4.5	19.5	38.0	-8.5	17.5	35.0	-8.5	-	-	-	C2V

Remarks 1. Typical performance. Please refer to **ELECTRICAL CHARACTERISTICS** in detail.
2. To know the associated product, please refer to each latest data sheet.

SYSTEM APPLICATION EXAMPLE

Location examples in digital cellular

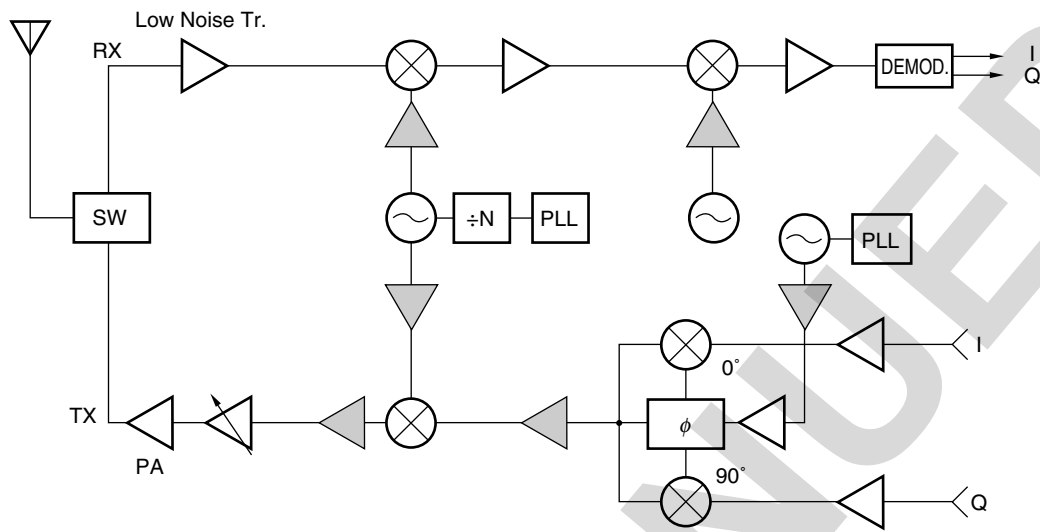

These ICs can be added to your system around Δ parts, when you need more isolation or gain. The application herein, however, shows only examples, therefore the application can depend on your kit evaluation.

DISCONTINUED

PIN CONNECTIONS

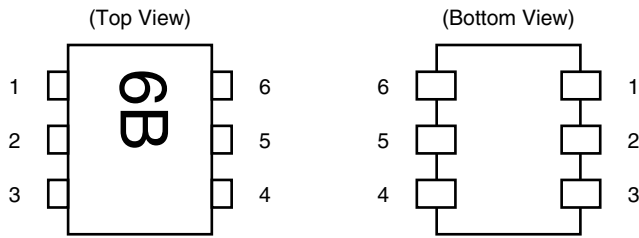

Pin No.	Pin Name
1	INPUT
2	GND
3	GND
4	OUTPUT
5	GND
6	V _{CC}

PIN EXPLANATION

Pin No.	Pin Name	Applied Voltage (V)	Pin Voltage (V) ^{Note}	Function and Applications	Internal Equivalent Circuit
1	INPUT	–	0.90	Signal input pin. A internal matching circuit, configured with resistors, enables 50 Ω connection over a wide band. This pin must be coupled to signal source with capacitor for DC cut.	
2 3 5	GND	0	–	Ground pin. This pin should be connected to system ground with minimum inductance. Ground pattern on the board should be formed as wide as possible. All the ground pins must be connected together with wide ground pattern to decrease impedance difference.	
4	OUTPUT	Voltage as same as V _{CC} through external inductor	–	Signal output pin. This pin is designed as collector output. Due to the high impedance output, this pin should be externally equipped with LC matching circuit to next stage. For L, a size 1 005 chip inductor can be chosen.	
6	V _{CC}	2.4 to 3.3	–	Power supply pin. This pin should be externally equipped with bypass capacitor to minimize its impedance.	

Note Pin voltage is measured at V_{CC} = 3.0 V.

ABSOLUTE MAXIMUM RATINGS

Parameter	Symbol	Test Conditions	Ratings	Unit
Supply Voltage	V _{CC}	T _A = +25°C, Pin 4, Pin 6	3.6	V
Circuit Current	I _{CC}	T _A = +25°C	15	mA
Power Dissipation	P _D	T _A = +85°C Note	232	mW
Operating Ambient Temperature	T _A		-40 to +85	°C
Storage Temperature	T _{stg}		-55 to +150	°C
Input Power	P _{in}	T _A = +25°C	+5	dBm

Note Mounted on double-sided copper-clad 50 × 50 × 1.6 mm epoxy glass PWB

RECOMMENDED OPERATING RANGE

Parameter	Symbol	MIN.	TYP.	MAX.	Unit	Remarks
Supply Voltage	V _{CC}	2.4	3.0	3.3	V	The same voltage should be applied to pin 4 and pin 6.
Operating Ambient Temperature	T _A	-40	+25	+85	°C	

ELECTRICAL CHARACTERISTICS

(Unless otherwise specified, T_A = +25°C, V_{CC} = V_{out} = 3.0 V, Z_s = Z_L = 50 Ω, at LC matched frequency)

Parameter	Symbol	Test Conditions	MIN.	TYP.	MAX.	Unit
Circuit Current	I _{CC}	No signal	1.4	1.9	2.4	mA
Power Gain	G _P	f = 1.0 GHz, P _{in} = -30 dBm f = 1.9 GHz, P _{in} = -30 dBm f = 2.4 GHz, P _{in} = -30 dBm	9.0 9.0 9.0	11.0 11.0 11.0	13.0 13.5 13.5	dB
Isolation	ISL	f = 1.0 GHz, P _{in} = -30 dBm f = 1.9 GHz, P _{in} = -30 dBm f = 2.4 GHz, P _{in} = -30 dBm	35.0 36.0 37.0	40.0 41.0 42.0	- - -	dB
Gain 1 dB Compression Output Power	P _{O(1 dB)}	f = 1.0 GHz f = 1.9 GHz f = 2.4 GHz	-8.0 -11.0 -11.5	-5.5 -8.0 -8.0	- - -	dBm
Noise Figure	NF	f = 1.0 GHz f = 1.9 GHz f = 2.4 GHz	- - -	5.5 5.5 5.5	7.0 7.0 7.0	dB
Input Return Loss	RL _{in}	f = 1.0 GHz, P _{in} = -30 dBm f = 1.9 GHz, P _{in} = -30 dBm f = 2.4 GHz, P _{in} = -30 dBm	4.0 5.0 6.5	7.0 8.0 9.5	- - -	dB

★ TEST CIRCUITS

<1> $f = 1.0 \text{ GHz}$

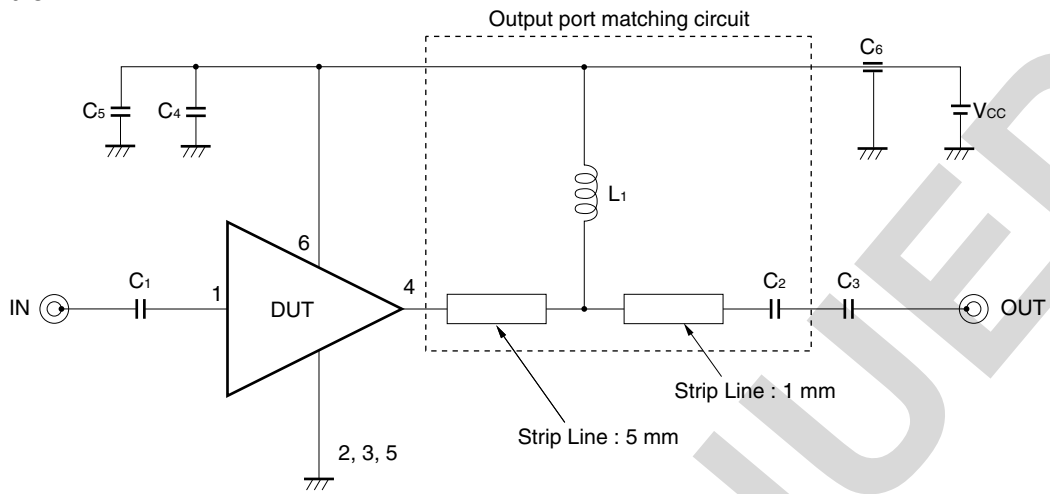

<2> $f = 1.9 \text{ GHz}$

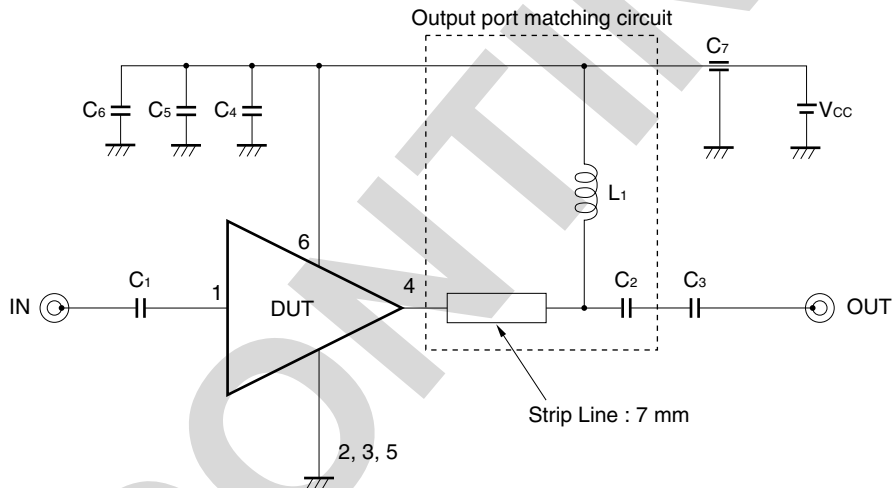

<3> $f = 2.4 \text{ GHz}$

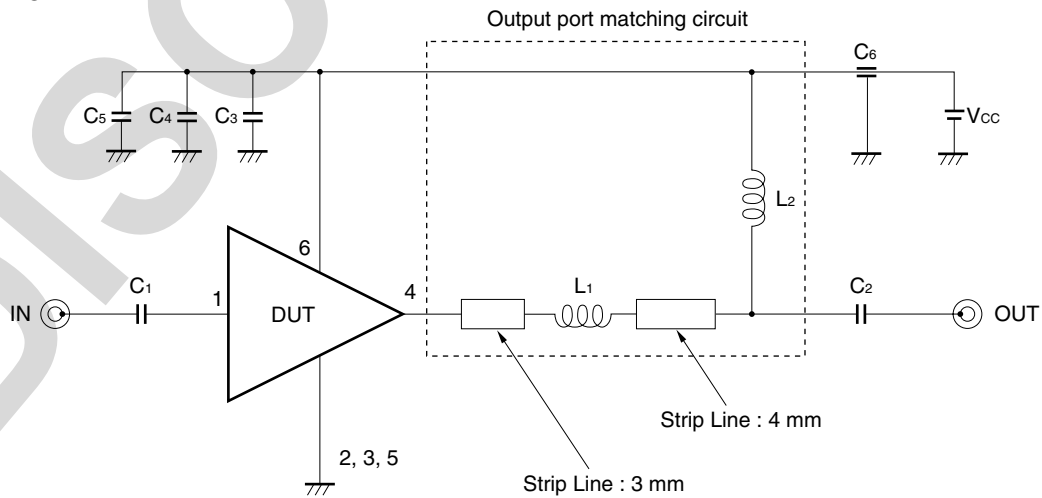

★ ILLUSTRATION OF THE TEST CIRCUIT ASSEMBLED ON EVALUATION BOARD

<1> f = 1.0 GHz

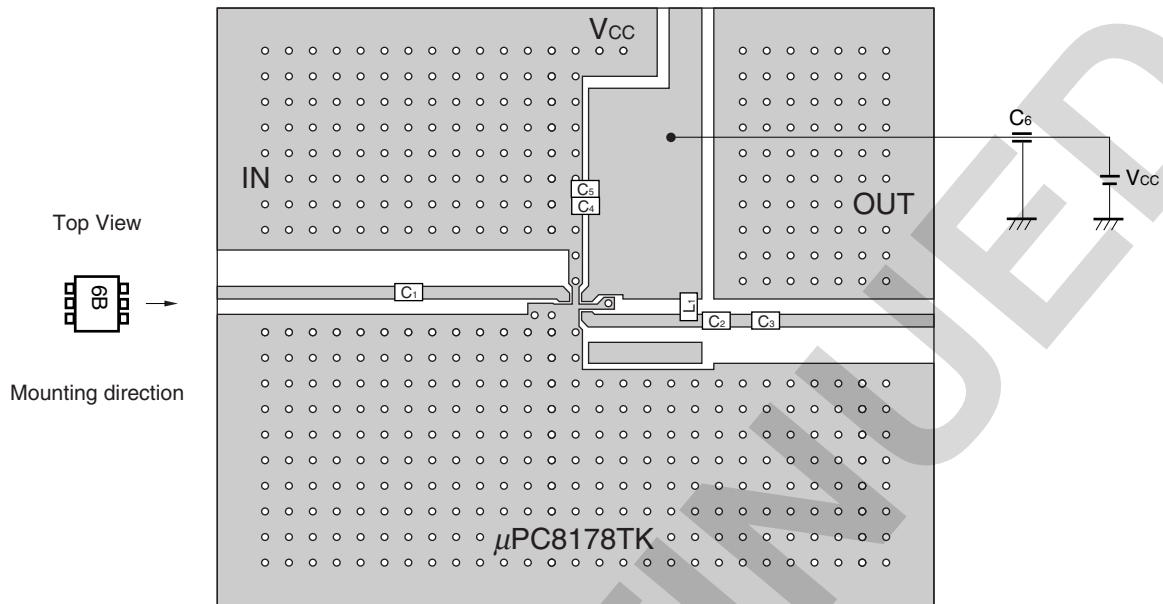

- (*1) 42 × 35 × 0.4 mm polyimide board, double-sided copper clad
- (*2) Back side: GND pattern
- (*3) Gold plated on pattern
- (*4) ○ : Through holes

COMPONENT LIST

Form	Symbol	Value	Type code	Maker
Chip capacitor	C ₁ , C ₃	1 000 pF	GRM40CH102J50PT	murata
	C ₂	0.75 pF	GRM39CKR75C50PT	murata
	C ₄	20 pF	GRM39CH200J50PT	murata
	C ₅	10 pF	GRM39CH100D50PT	murata
Feed-through Capacitor	C ₆	1 000 pF	DFT301-801 × 7R102S50	murata
Chip inductor	L ₁	12 nH	LL1608-FH12N	TOKO

<2> f = 1.9 GHz

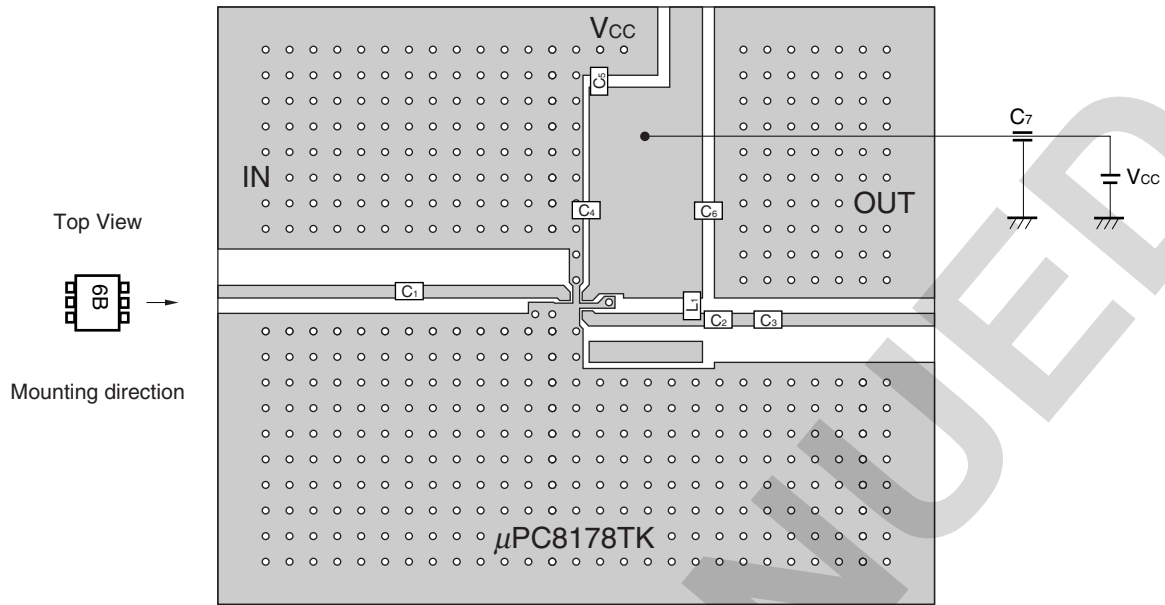

- (*1) 42 × 35 × 0.4 mm polyimide board, double-sided copper clad
- (*2) Back side: GND pattern
- (*3) Gold plated on pattern
- (*4) ○ : Through holes

COMPONENT LIST

Form	Symbol	Value	Type code	Maker
Chip capacitor	C ₁ , C ₃ , C ₅ , C ₆	1 000 pF	GRM40CH102J50PT	murata
	C ₂	0.5 pF	GRM39CKR5C50PT	murata
	C ₄	8 pF	GRM39CH080D50PT	murata
Feed-through Capacitor	C ₇	1 000 pF	DFT301-801 × 7R102S50	murata
Chip inductor	L ₁	2.7 nH	LL1608-FH2N7S	TOKO

<3> f = 2.4 GHz

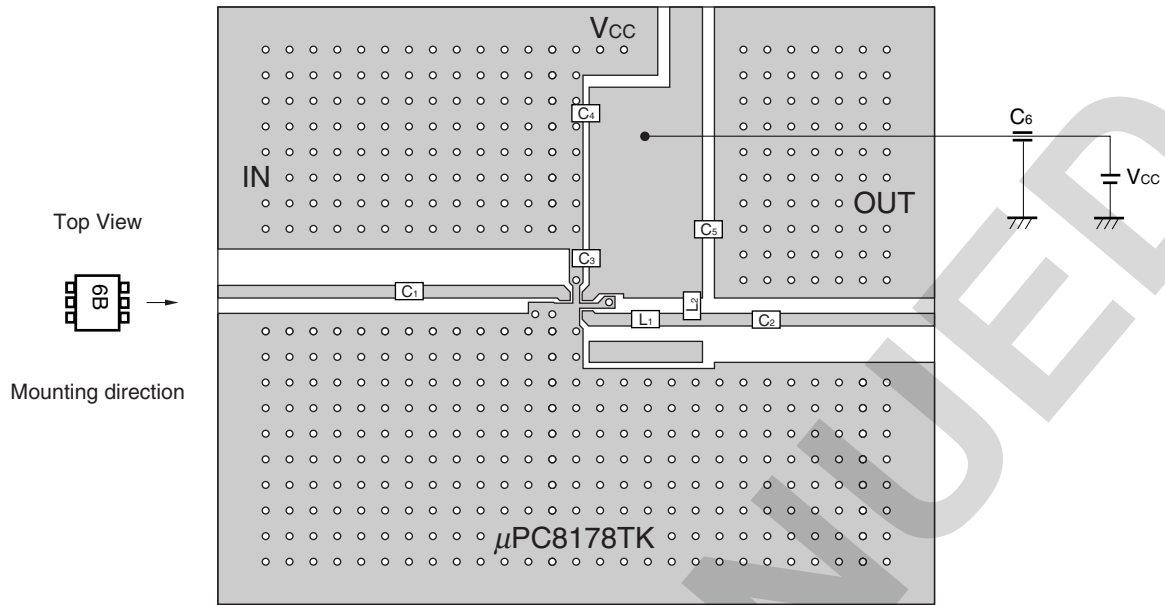

- (*1) 42 × 35 × 0.4 mm polyimide board, double-sided copper clad
- (*2) Back side: GND pattern
- (*3) Gold plated on pattern
- (*4) o : Through holes

COMPONENT LIST

Form	Symbol	Value	Type code	Maker
Chip capacitor	C ₁ , C ₂ , C ₄ , C ₅	1 000 pF	GRM40CH102J50PT	murata
	C ₃	10 pF	GRM39CH100D50PT	murata
Feed-through Capacitor	C ₆	1 000 pF	DFT301-801 × 7R102S50	murata
Chip inductor	L ₁	2.7 nH	LL1608-FH2N7S	TOKO
	L ₂	1.8 nH	LL1608-FH1N8S	TOKO

★ TYPICAL CHARACTERISTICS ($T_A = +25^\circ\text{C}$, unless otherwise specified)

CIRCUIT CURRENT vs. SUPPLY VOLTAGE

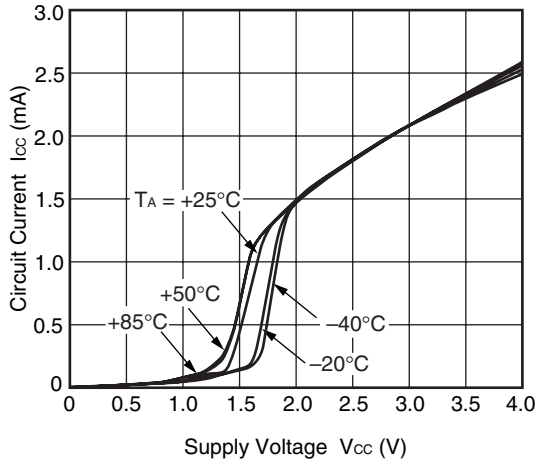

Remark The graph indicates nominal characteristics.

DISCONTINUED

f = 1.0 GHz MATCHING

S₁₁-FREQUENCY

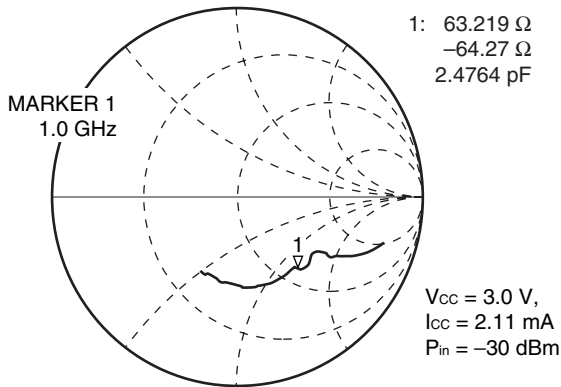

START 100.000 000 MHz STOP 3 100.000 000 MHz

S₂₂-FREQUENCY

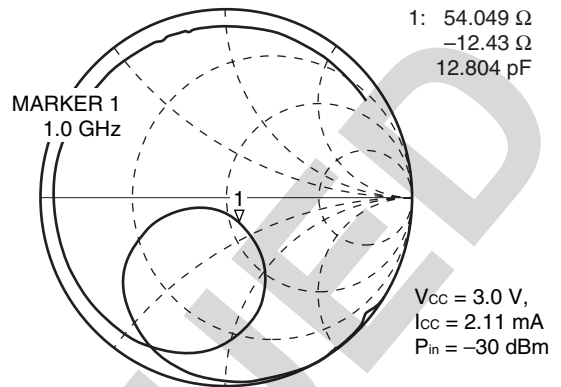

START 100.000 000 MHz STOP 3 100.000 000 MHz

S₁₁-FREQUENCY

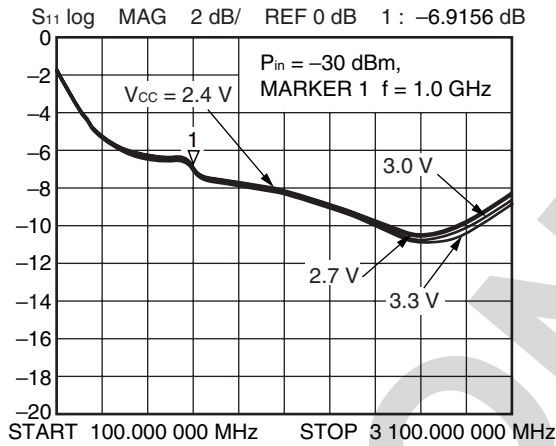

S₁₂-FREQUENCY

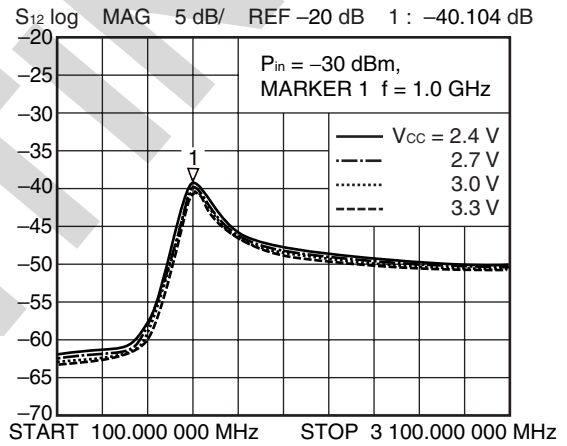

S₂₁-FREQUENCY

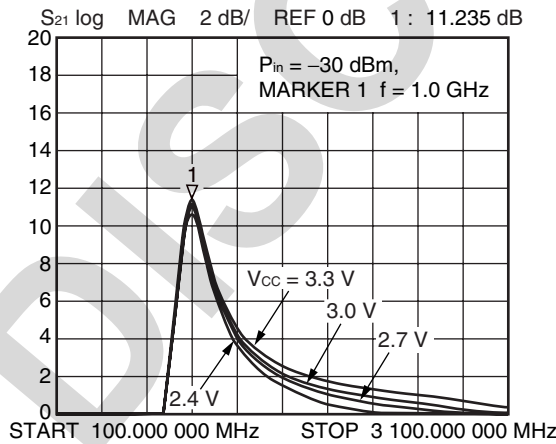

S₂₂-FREQUENCY

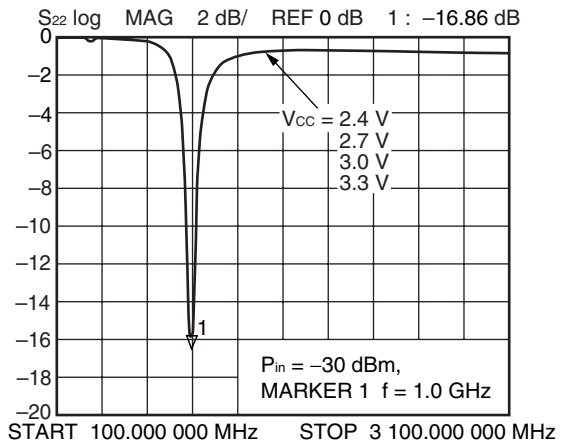

Remark The graphs indicate nominal characteristics.

S₁₁-FREQUENCY

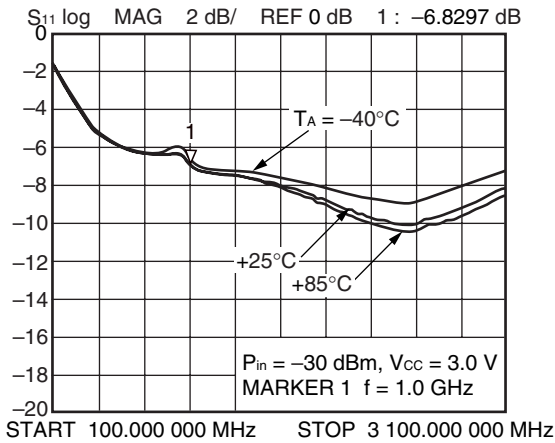

S₁₂-FREQUENCY

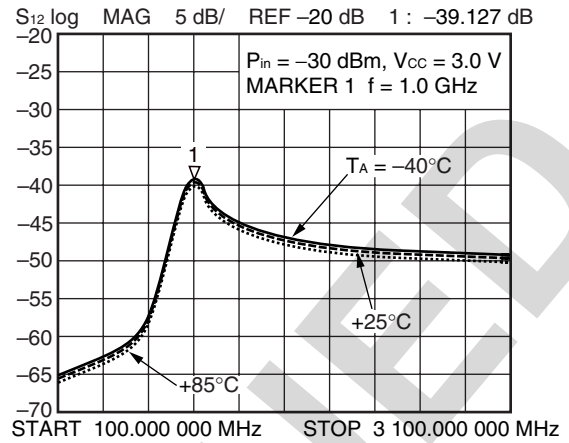

S₂₁-FREQUENCY

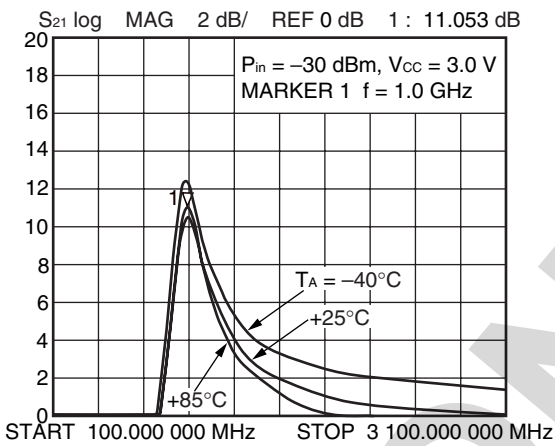

S₂₂-FREQUENCY

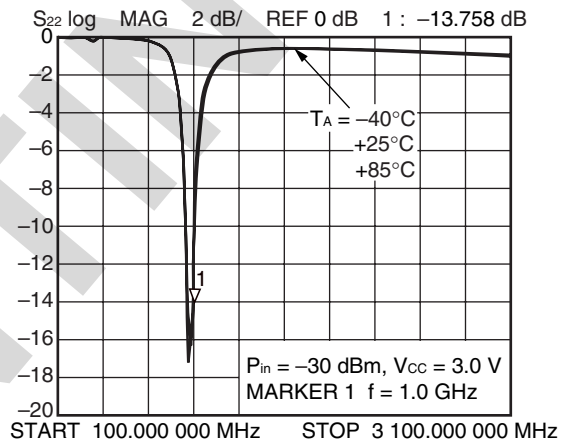

Remark The graphs indicate nominal characteristics.

OUTPUT POWER vs. INPUT POWER

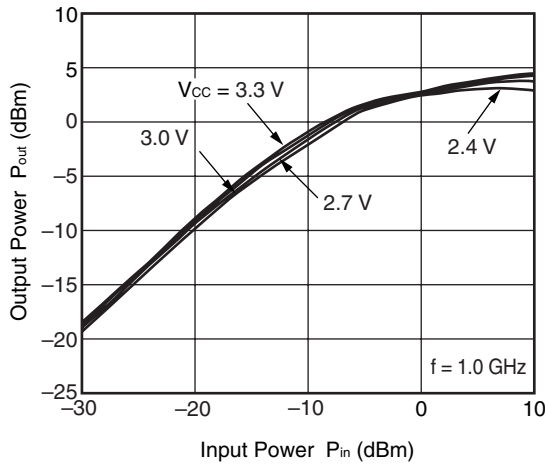

OUTPUT POWER vs. INPUT POWER

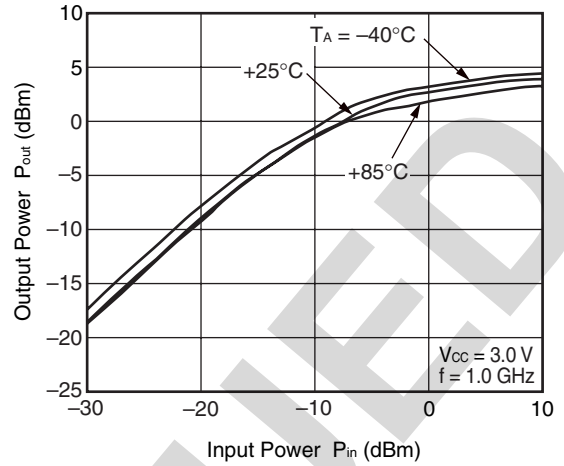

OUTPUT POWER, IM_3 vs. INPUT POWER

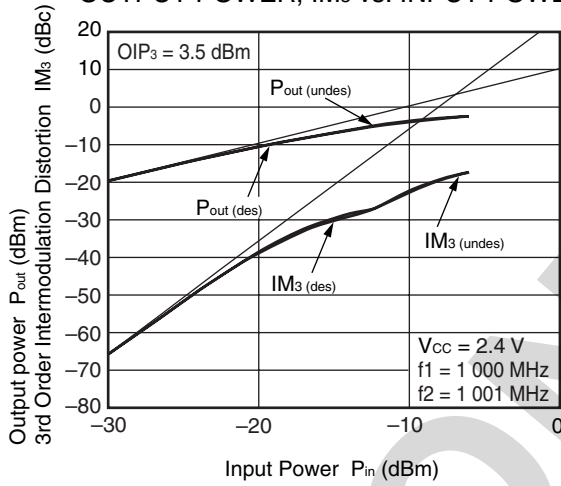

OUTPUT POWER, IM_3 vs. INPUT POWER

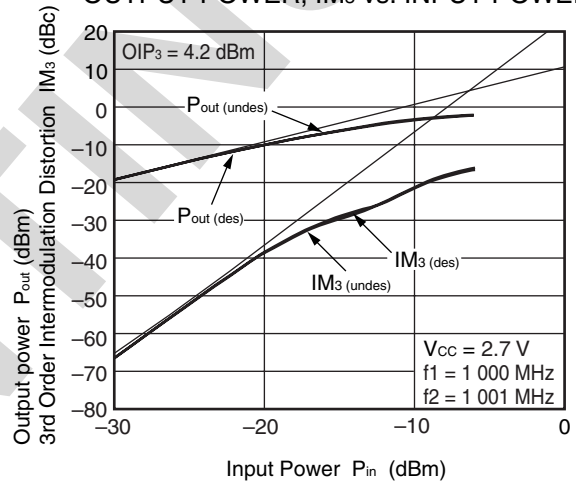

OUTPUT POWER, IM_3 vs. INPUT POWER

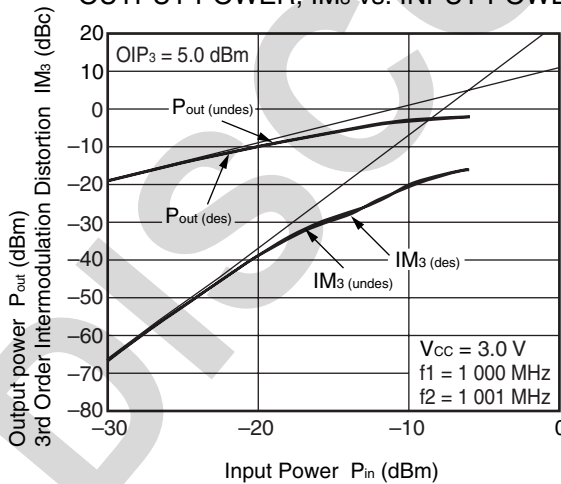

OUTPUT POWER, IM_3 vs. INPUT POWER

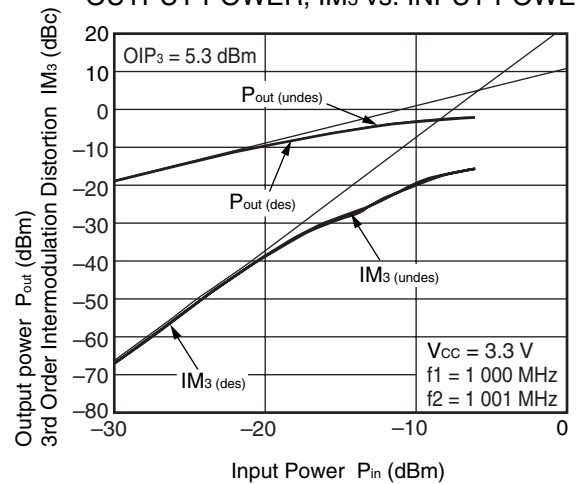

Remark The graphs indicate nominal characteristics.

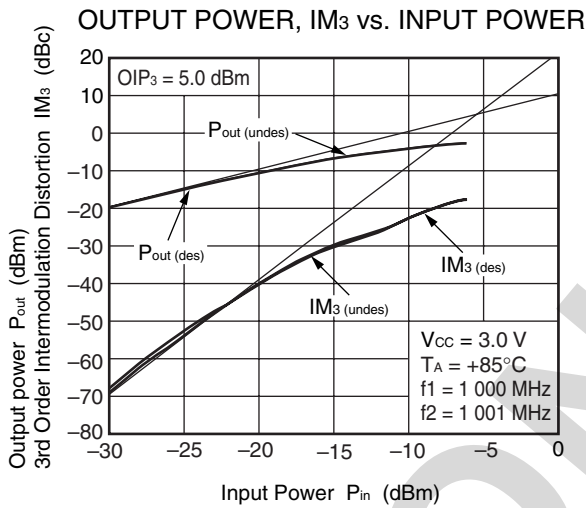
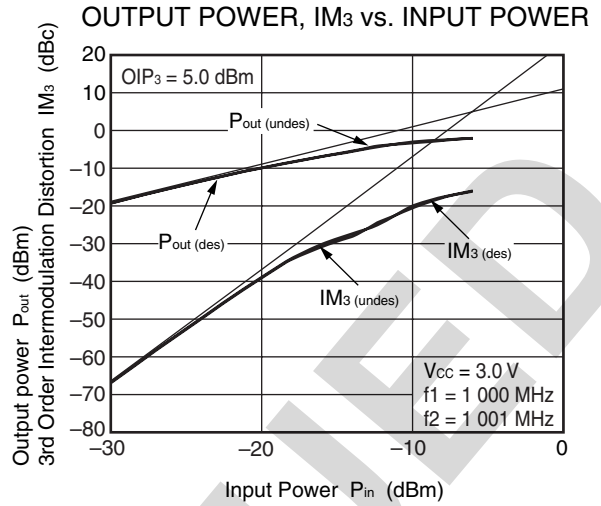
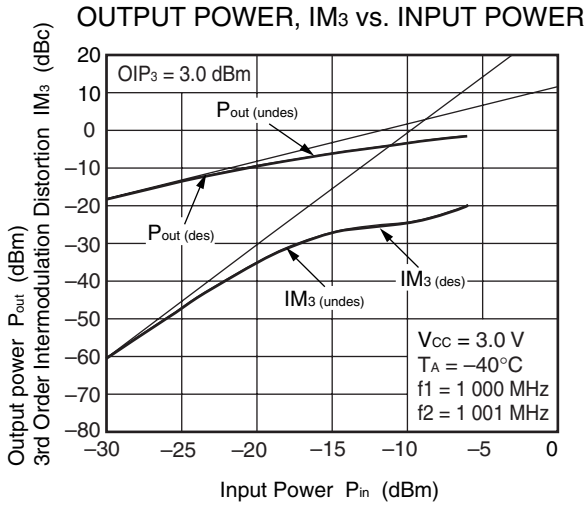

3RD ORDER INTERMODULATION DISTORTION vs. OUTPUT POWER OF EACH TONE

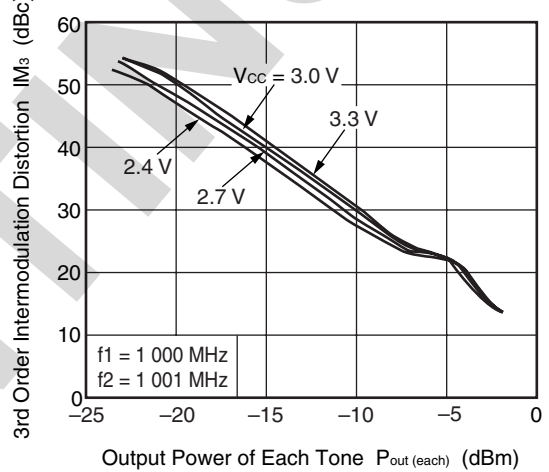

NOISE FIGURE vs. SUPPLY VOLTAGE

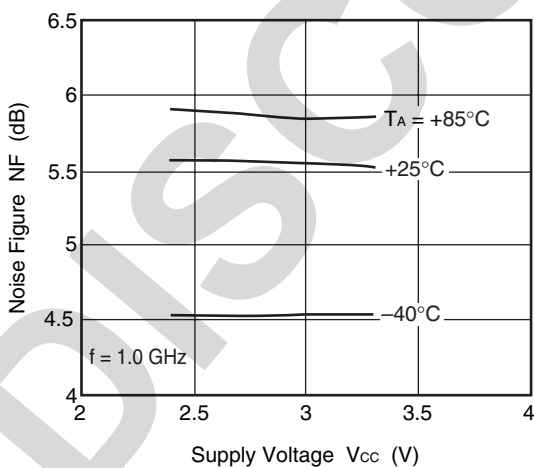

Remark The graphs indicate nominal characteristics.

f = 1.9 GHz MATCHING

S₁₁-FREQUENCY

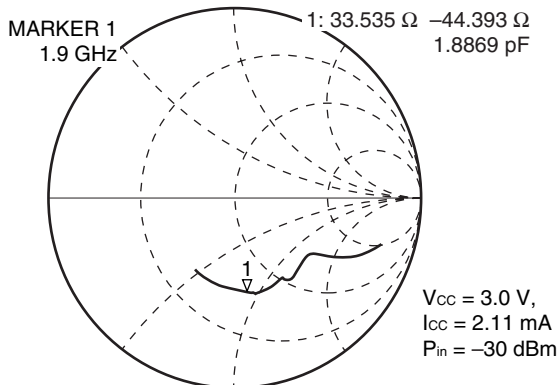

START 100.000 000 MHz STOP 3 100.000 000 MHz

S₂₂-FREQUENCY

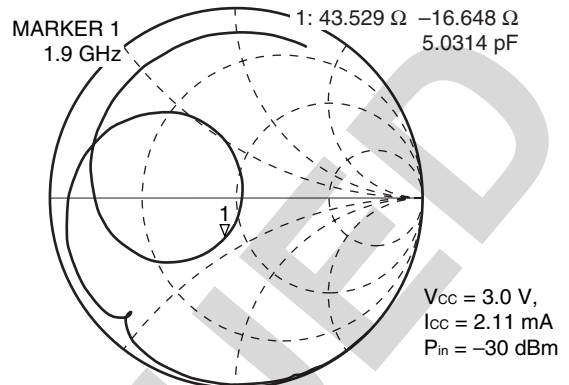

START 100.000 000 MHz STOP 3 100.000 000 MHz

S₁₁-FREQUENCY

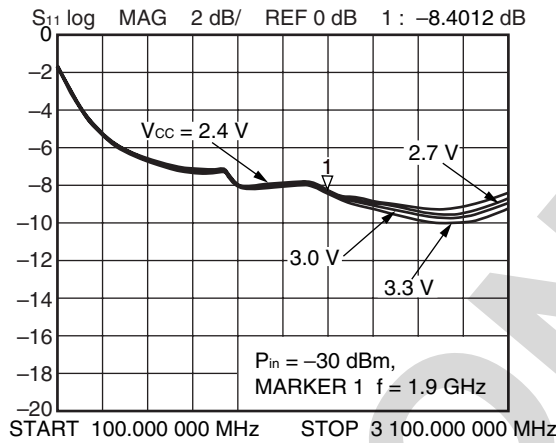

S₁₂-FREQUENCY

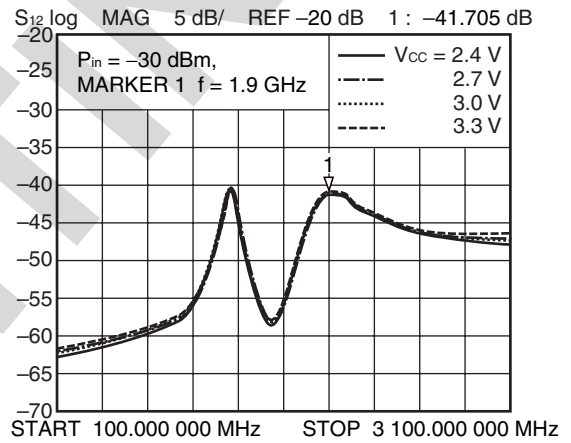

S₂₁-FREQUENCY

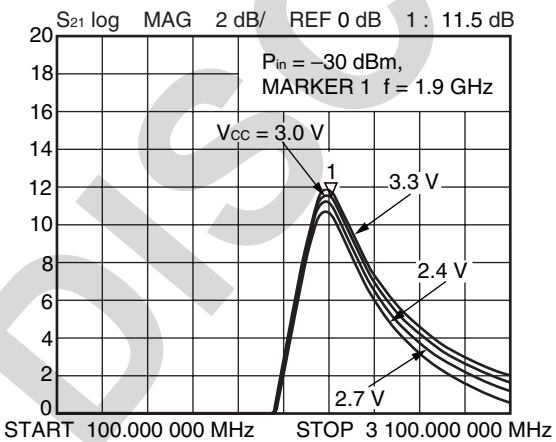

S₂₂-FREQUENCY

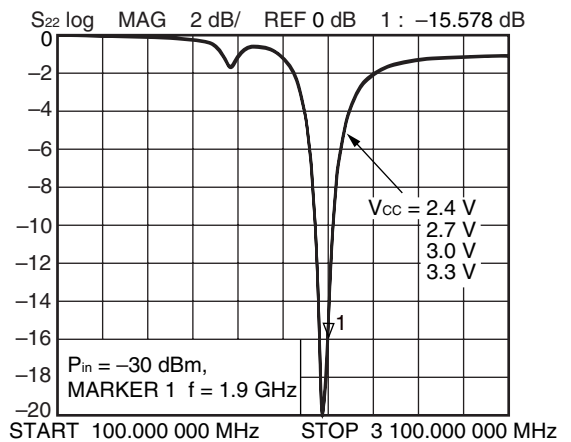

Remark The graphs indicate nominal characteristics.

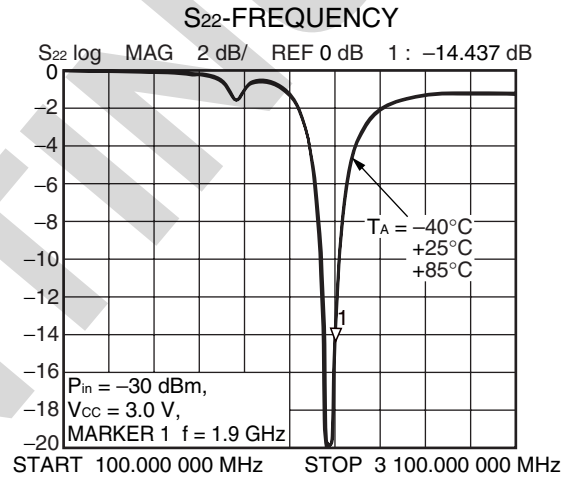
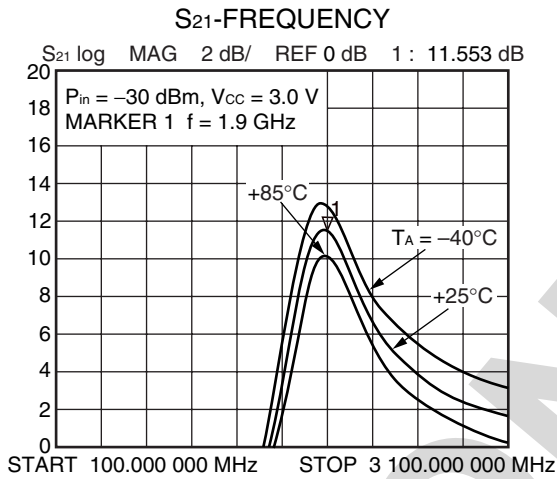
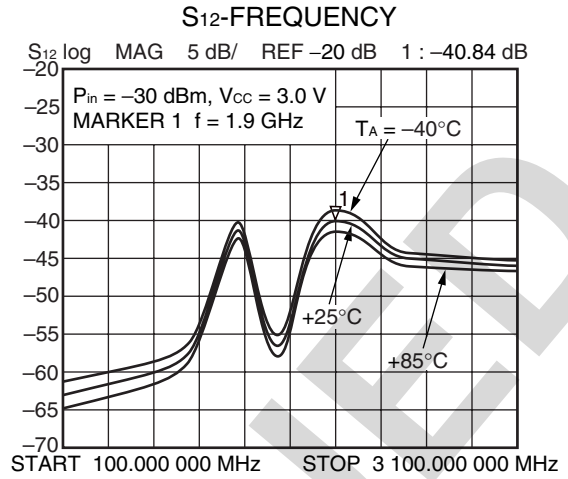
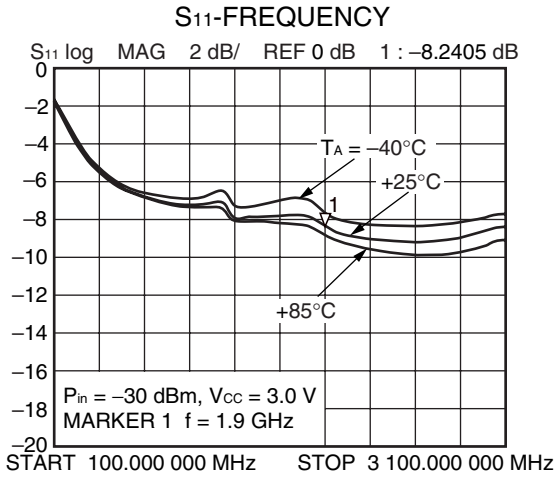

Remark The graphs indicate nominal characteristics.

OUTPUT POWER vs. INPUT POWER

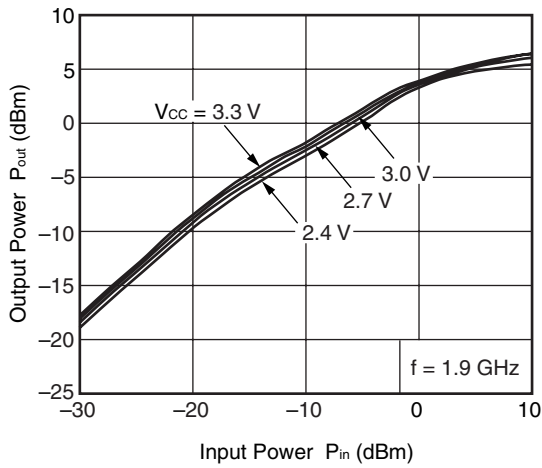

OUTPUT POWER vs. INPUT POWER

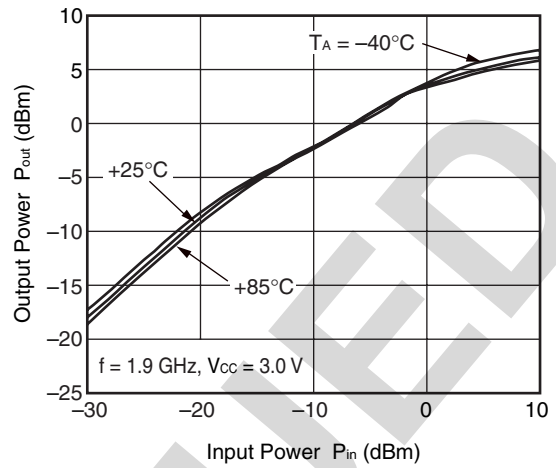

OUTPUT POWER, IM3 vs. INPUT POWER

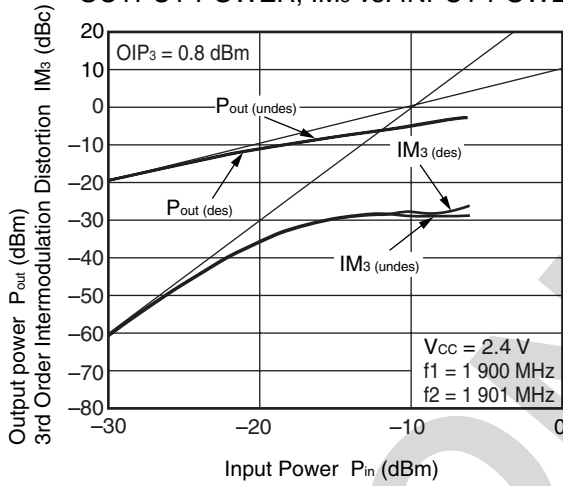

OUTPUT POWER, IM3 vs. INPUT POWER

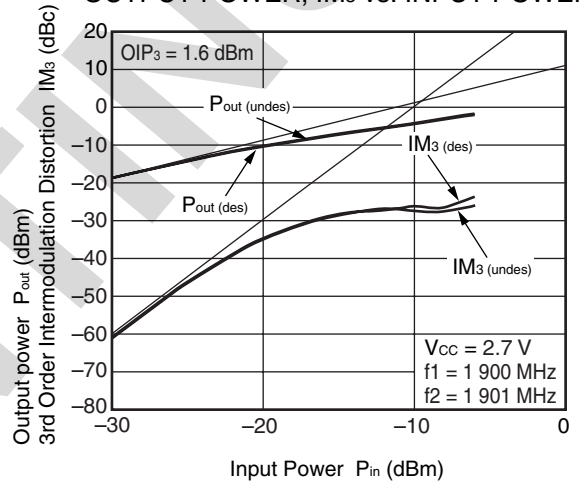

OUTPUT POWER, IM3 vs. INPUT POWER

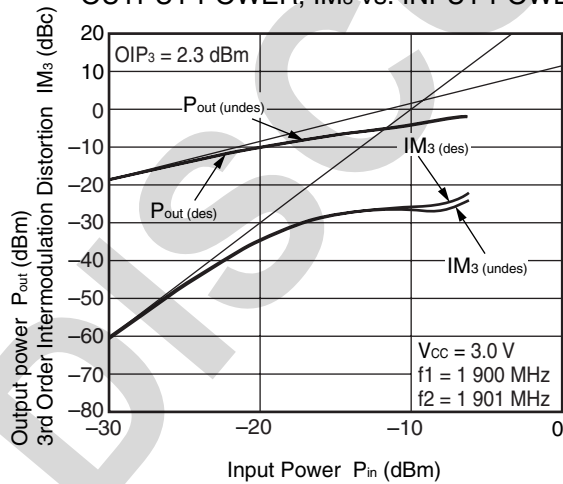

OUTPUT POWER, IM3 vs. INPUT POWER

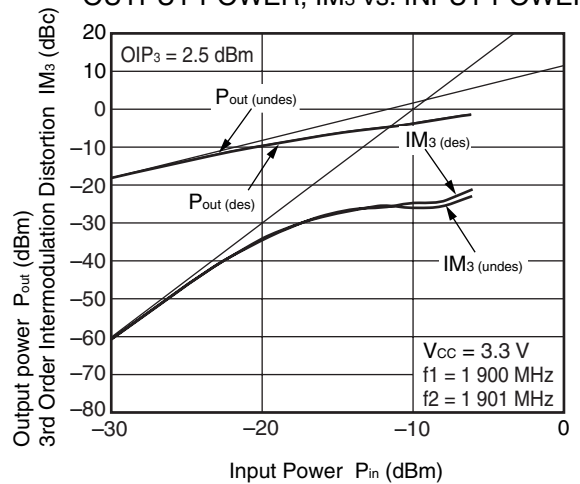

Remark The graphs indicate nominal characteristics.

OUTPUT POWER, IM₃ vs. INPUT POWER

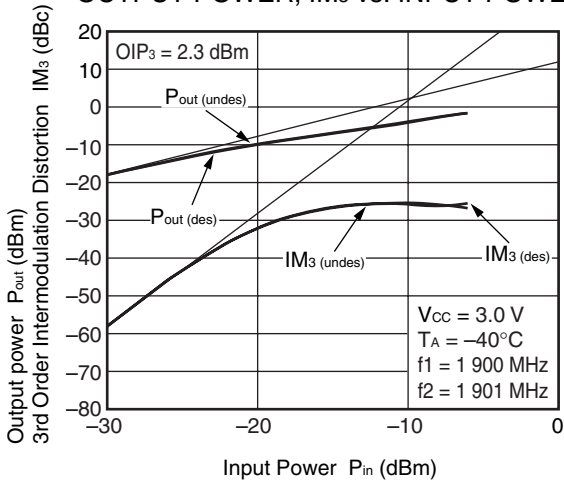

OUTPUT POWER, IM₃ vs. INPUT POWER

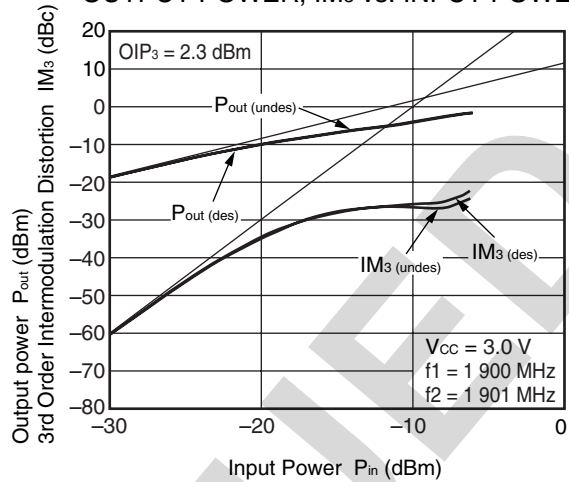

OUTPUT POWER, IM₃ vs. INPUT POWER

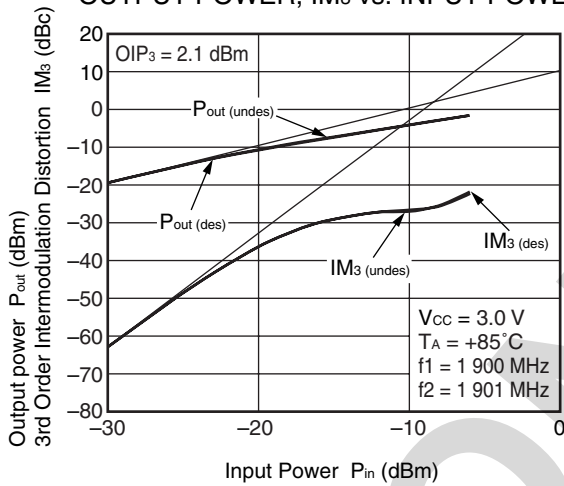

3RD ORDER INTERMODULATION DISTORTION vs. OUTPUT POWER OF EACH TONE

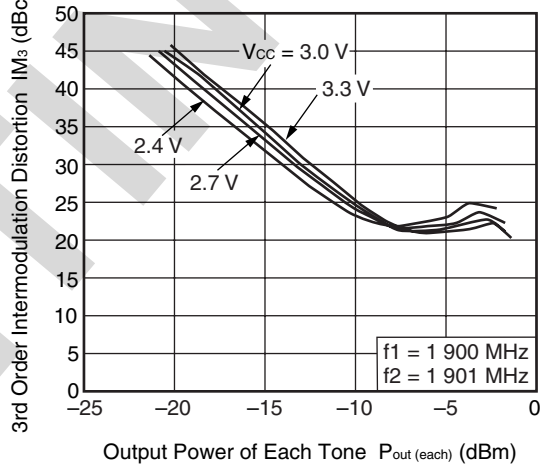

NOISE FIGURE vs. SUPPLY VOLTAGE

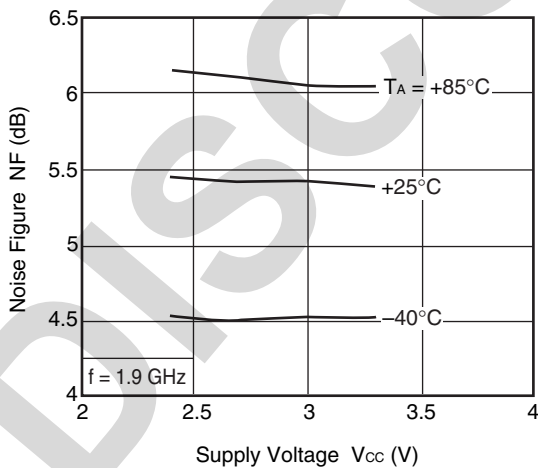

Remark The graphs indicate nominal characteristics.

f = 2.4 GHz MATCHING

S₁₁-FREQUENCY

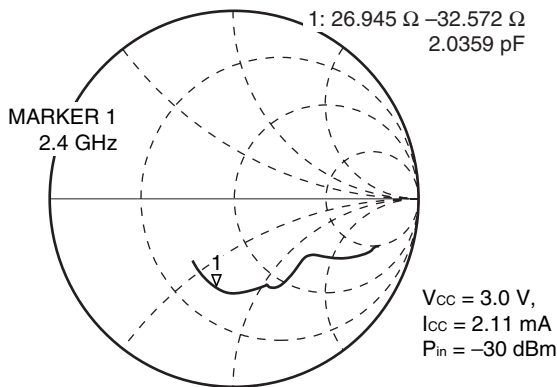

START 100.000 000 MHz STOP 3 100.000 000 MHz

S₂₂-FREQUENCY

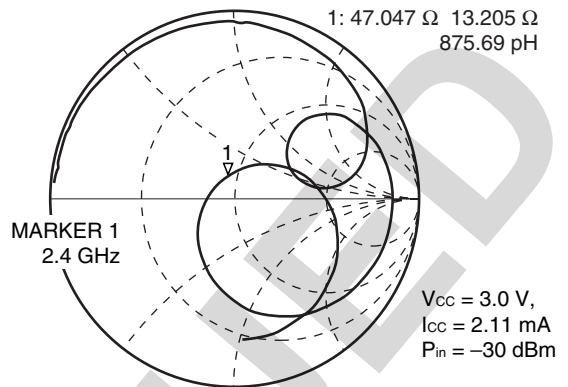

START 100.000 000 MHz STOP 3 100.000 000 MHz

S₁₁-FREQUENCY

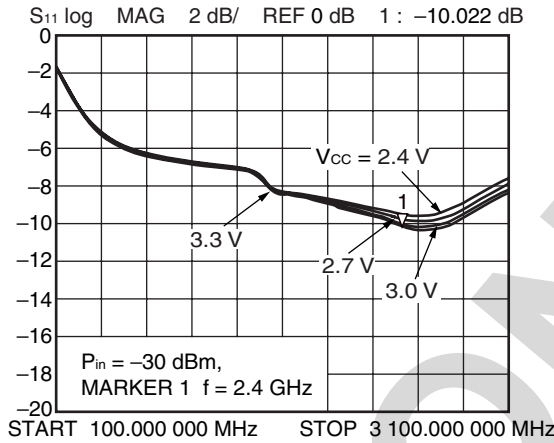

S₁₂-FREQUENCY

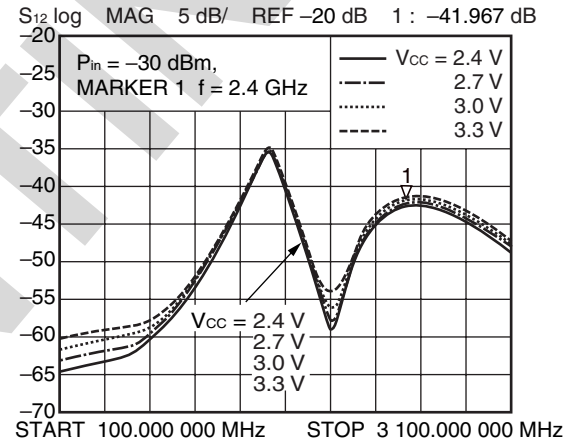

S₂₁-FREQUENCY

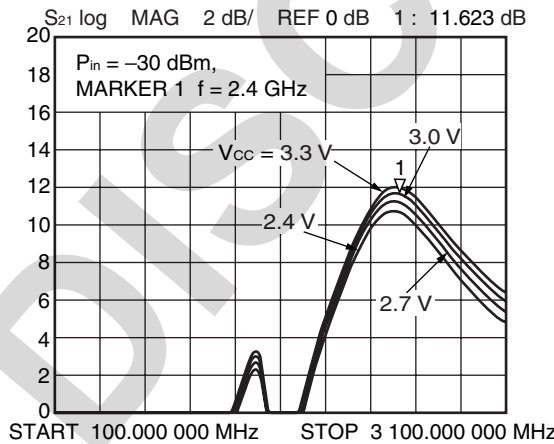

S₂₂-FREQUENCY

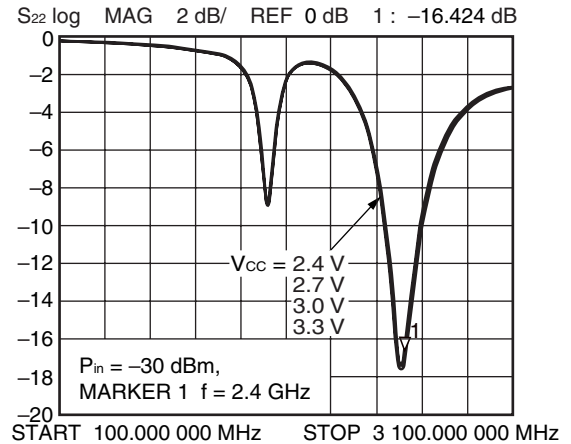

Remark The graphs indicate nominal characteristics.

S11-FREQUENCY

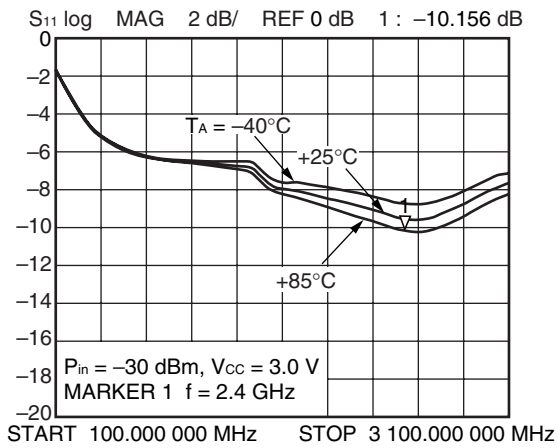

S12-FREQUENCY

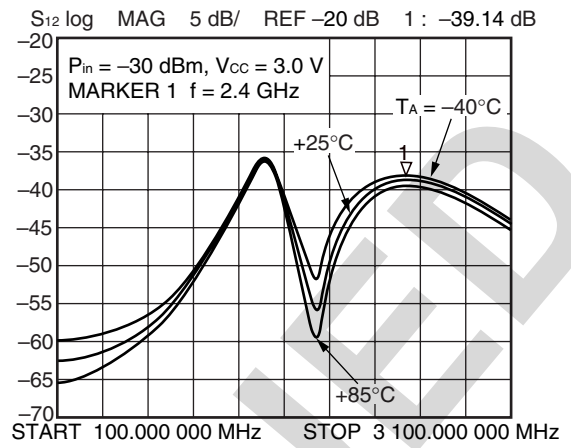

S21-FREQUENCY

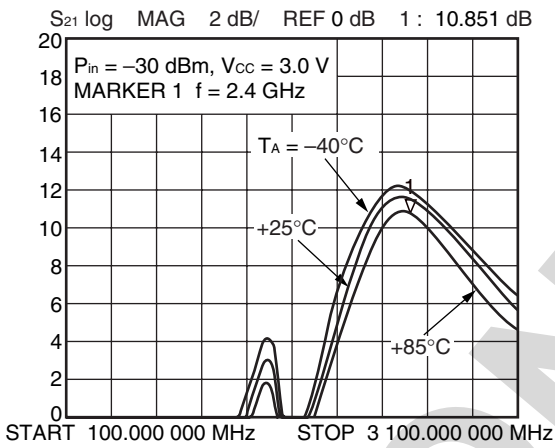

S22-FREQUENCY

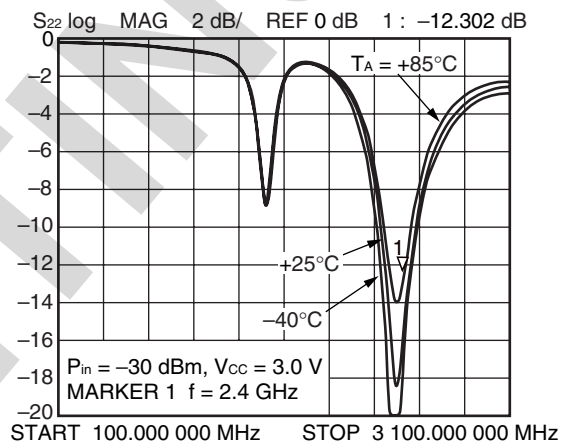

Remark The graphs indicate nominal characteristics.

OUTPUT POWER vs. INPUT POWER

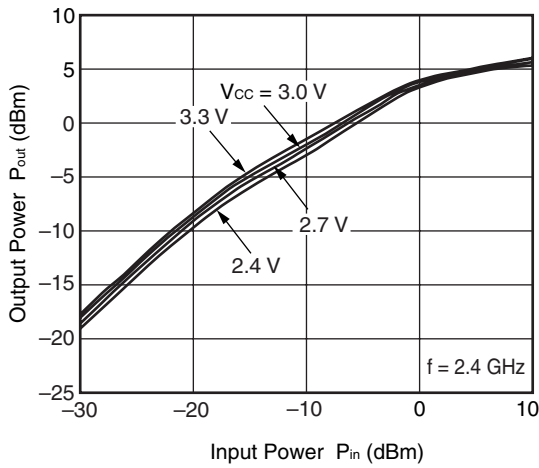

OUTPUT POWER vs. INPUT POWER

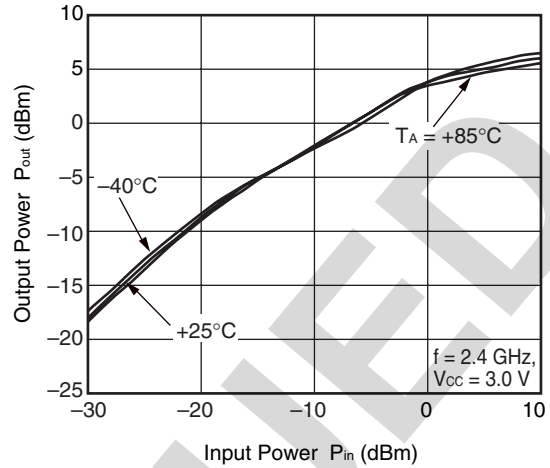

OUTPUT POWER, IM3 vs. INPUT POWER

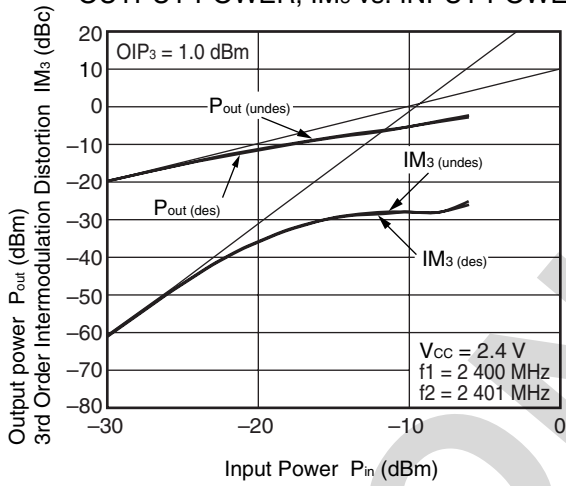

OUTPUT POWER, IM3 vs. INPUT POWER

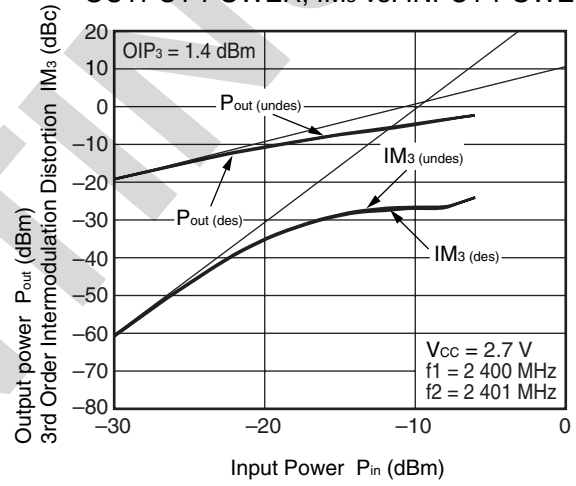

OUTPUT POWER, IM3 vs. INPUT POWER

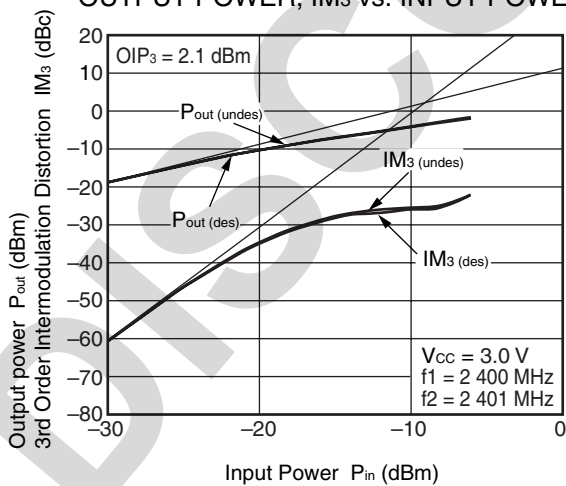

OUTPUT POWER, IM3 vs. INPUT POWER

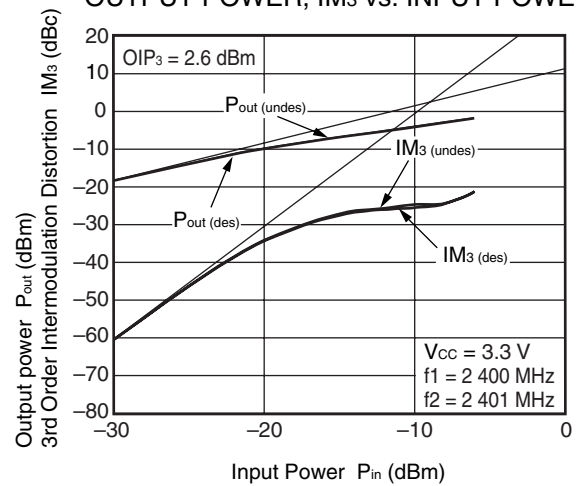

Remark The graphs indicate nominal characteristics.

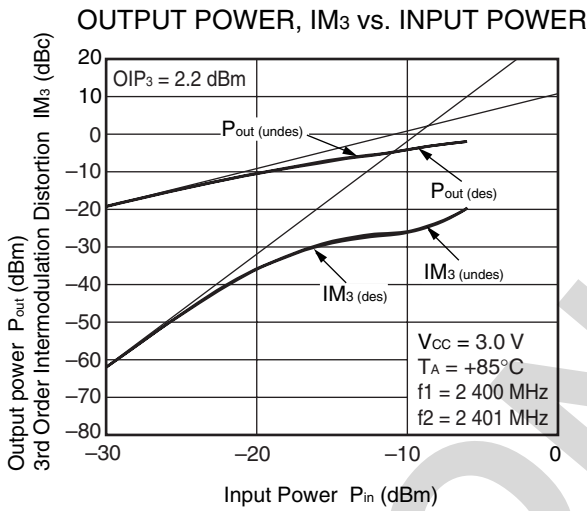
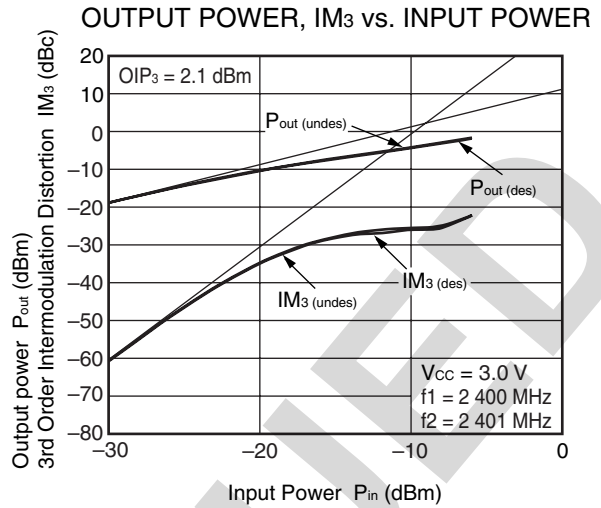
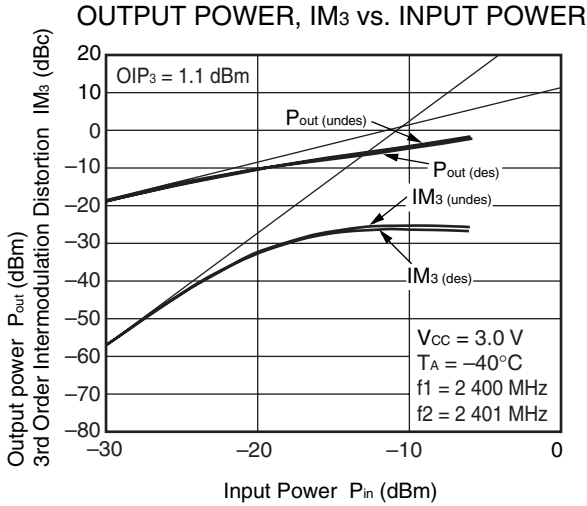

3RD ORDER INTERMODULATION DISTORTION vs. OUTPUT POWER OF EACH TONE

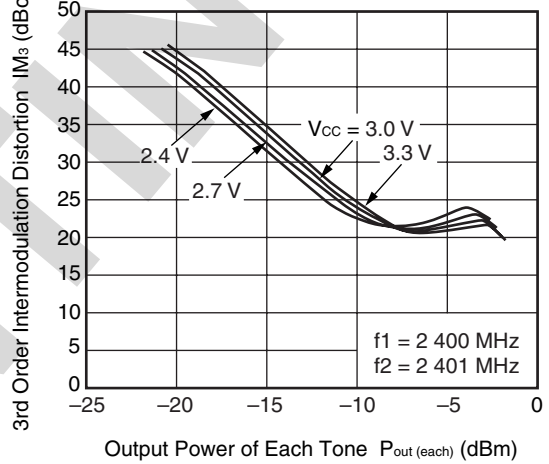

NOISE FIGURE vs. SUPPLY VOLTAGE

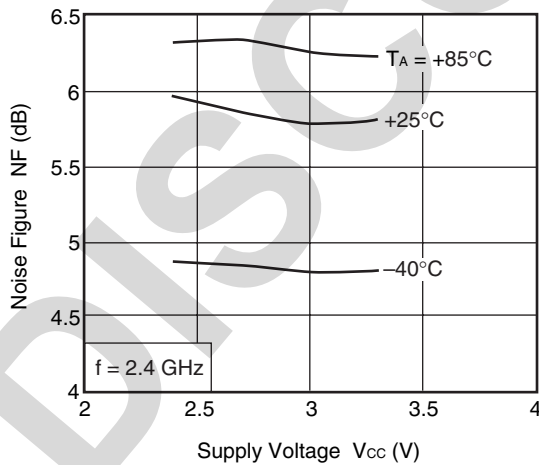

Remark The graphs indicate nominal characteristics.

f = 3.0 GHz MATCHING

S₁₁-FREQUENCY

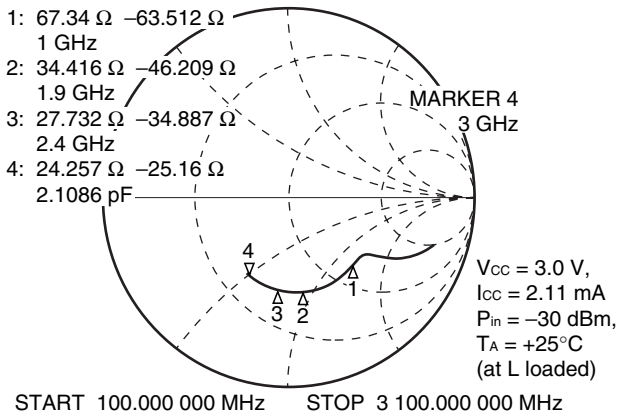

S₂₂-FREQUENCY

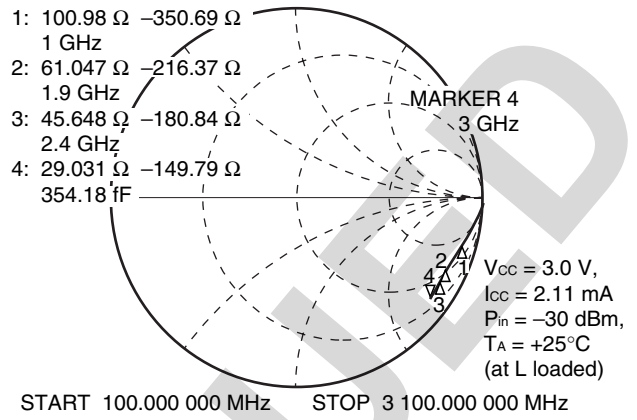

Remark The graphs indicate nominal characteristics.

DISCONTINUED

★ PACKAGE DIMENSIONS

6-PIN LEAD-LESS MINIMOLD (1511) (UNIT: mm)

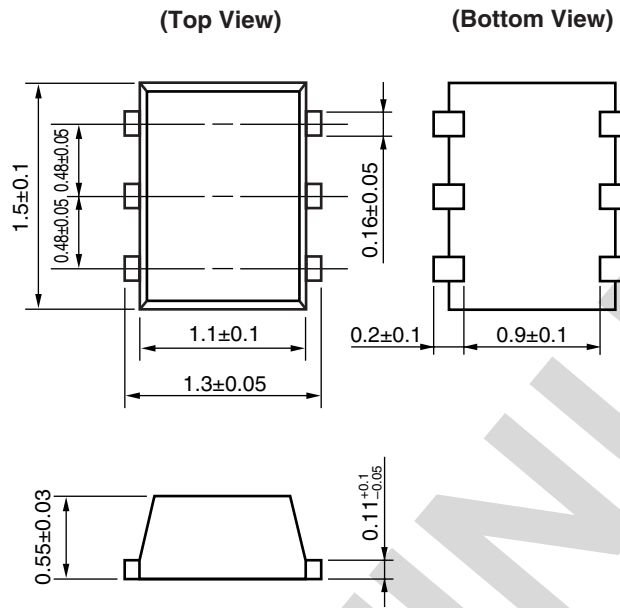

DISCONTINUED

NOTE ON CORRECT USE

- (1) Observe precautions for handling because of electro-static sensitive devices.
- (2) Form a ground pattern as widely as possible to minimize ground impedance (to prevent undesired oscillation).
All the ground pins must be connected together with wide ground pattern to decrease impedance difference.
- (3) The bypass capacitor should be attached to Vcc line.
- (4) The inductor (L) should be attached between output and Vcc pins. The L and series capacitor (C) values should be adjusted for applied frequency to match impedance to next stage.
- (5) The DC capacitor must be attached to input pin.

★ **RECOMMENDED SOLDERING CONDITIONS**

This product should be soldered and mounted under the following recommended conditions. For soldering methods and conditions other than those recommended below, contact your nearby sales office.

Soldering Method	Soldering Conditions	Condition Symbol
Infrared Reflow	Peak temperature (package surface temperature) : 260°C or below Time at peak temperature : 10 seconds or less Time at temperature of 220°C or higher : 60 seconds or less Preheating time at 120 to 180°C : 120±30 seconds Maximum number of reflow processes : 3 times Maximum chlorine content of rosin flux (% mass) : 0.2%(Wt.) or below	IR260
Wave Soldering	Peak temperature (molten solder temperature) : 260°C or below Time at peak temperature : 10 seconds or less Preheating temperature (package surface temperature) : 120°C or below Maximum number of flow processes : 1 time Maximum chlorine content of rosin flux (% mass) : 0.2%(Wt.) or below	WS260
Partial Heating	Peak temperature (terminal temperature) : 350°C or below Soldering time (per side of device) : 3 seconds or less Maximum chlorine content of rosin flux (% mass) : 0.2%(Wt.) or below	HS350

Caution Do not use different soldering methods together (except for partial heating).

NOTICE

1. Descriptions of circuits, software and other related information in this document are provided only to illustrate the operation of semiconductor products and application examples. You are fully responsible for the incorporation of these circuits, software, and information in the design of your equipment. California Eastern Laboratories and Renesas Electronics assumes no responsibility for any losses incurred by you or third parties arising from the use of these circuits, software, or information.
2. California Eastern Laboratories has used reasonable care in preparing the information included in this document, but California Eastern Laboratories does not warrant that such information is error free. California Eastern Laboratories and Renesas Electronics assumes no liability whatsoever for any damages incurred by you resulting from errors in or omissions from the information included herein.
3. California Eastern Laboratories and Renesas Electronics do not assume any liability for infringement of patents, copyrights, or other intellectual property rights of third parties by or arising from the use of Renesas Electronics products or technical information described in this document. No license, express, implied or otherwise, is granted hereby under any patents, copyrights or other intellectual property rights of California Eastern Laboratories or Renesas Electronics or others.
4. You should not alter, modify, copy, or otherwise misappropriate any Renesas Electronics product, whether in whole or in part. California Eastern Laboratories and Renesas Electronics assume no responsibility for any losses incurred by you or third parties arising from such alteration, modification, copy or otherwise misappropriation of Renesas Electronics product.
5. Renesas Electronics products are classified according to the following two quality grades: "Standard" and "High Quality". The recommended applications for each Renesas Electronics product depends on the product's quality grade, as indicated below. "Standard": Computers; office equipment; communications equipment; test and measurement equipment; audio and visual equipment; home electronic appliances; machine tools; personal electronic equipment; and industrial robots etc. "High Quality": Transportation equipment (automobiles, trains, ships, etc.); traffic control systems; anti-disaster systems; anti-crime systems; and safety equipment etc. Renesas Electronics products are neither intended nor authorized for use in products or systems that may pose a direct threat to human life or bodily injury (artificial life support devices or systems, surgical implantations etc.), or may cause serious property damages (nuclear reactor control systems, military equipment etc.). You must check the quality grade of each Renesas Electronics product before using it in a particular application. You may not use any Renesas Electronics product for any application for which it is not intended. California Eastern Laboratories and Renesas Electronics shall not be in any way liable for any damages or losses incurred by you or third parties arising from the use of any Renesas Electronics product for which the product is not intended by California Eastern Laboratories or Renesas Electronics.
6. You should use the Renesas Electronics products described in this document within the range specified by California Eastern Laboratories, especially with respect to the maximum rating, operating supply voltage range, movement power voltage range, heat radiation characteristics, installation and other product characteristics. California Eastern Laboratories shall have no liability for malfunctions or damages arising out of the use of Renesas Electronics products beyond such specified ranges.
7. Although Renesas Electronics endeavors to improve the quality and reliability of its products, semiconductor products have specific characteristics such as the occurrence of failure at a certain rate and malfunctions under certain use conditions. Further, Renesas Electronics products are not subject to radiation resistance design. Please be sure to implement safety measures to guard them against the possibility of physical injury, and injury or damage caused by fire in the event of the failure of a Renesas Electronics product, such as safety design for hardware and software including but not limited to redundancy, fire control and malfunction prevention, appropriate treatment for aging degradation or any other appropriate measures. Because the evaluation of microcomputer software alone is very difficult, please evaluate the safety of the final products or systems manufactured by you.
8. Please contact a California Eastern Laboratories sales office for details as to environmental matters such as the environmental compatibility of each Renesas Electronics product. Please use Renesas Electronics products in compliance with all applicable laws and regulations that regulate the inclusion or use of controlled substances, including without limitation, the EU RoHS Directive. California Eastern Laboratories and Renesas Electronics assume no liability for damages or losses occurring as a result of your noncompliance with applicable laws and regulations.
9. Renesas Electronics products and technology may not be used for or incorporated into any products or systems whose manufacture, use, or sale is prohibited under any applicable domestic or foreign laws or regulations. You should not use Renesas Electronics products or technology described in this document for any purpose relating to military applications or use by the military, including but not limited to the development of weapons of mass destruction. When exporting the Renesas Electronics products or technology described in this document, you should comply with the applicable export control laws and regulations and follow the procedures required by such laws and regulations.
10. It is the responsibility of the buyer or distributor of California Eastern Laboratories, who distributes, disposes of, or otherwise places the Renesas Electronics product with a third party, to notify such third party in advance of the contents and conditions set forth in this document, California Eastern Laboratories and Renesas Electronics assume no responsibility for any losses incurred by you or third parties as a result of unauthorized use of Renesas Electronics products.
11. This document may not be reproduced or duplicated in any form, in whole or in part, without prior written consent of California Eastern Laboratories.
12. Please contact a California Eastern Laboratories sales office if you have any questions regarding the information contained in this document or Renesas Electronics products, or if you have any other inquiries.

NOTE 1: "Renesas Electronics" as used in this document means Renesas Electronics Corporation and also includes its majority-owned subsidiaries.

NOTE 2: "Renesas Electronics product(s)" means any product developed or manufactured by or for Renesas Electronics.

NOTE 3: Products and product information are subject to change without notice.

CEL Headquarters • 4590 Patrick Henry Drive, Santa Clara, CA 95054 • Phone (408) 919-2500 • www.cel.com

For a complete list of sales offices, representatives and distributors,
Please visit our website: www.cel.com/contactus