

High Current Density Surface Mount Ultrafast High Voltage Rectifier

eSMP® Series

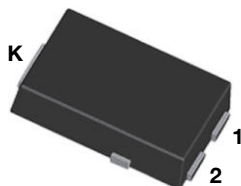

TO-277A (SMPC)

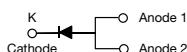

PRIMARY CHARACTERISTICS	
$I_{F(AV)}$	6.0 A
V_{RRM}	600 V
I_{FSM}	80 A
t_{rr}	25 ns
V_F at $I_F = 6.0$ A	1.3 V
T_J max.	175 °C

TYPICAL APPLICATIONS

For use in high voltage, high frequency power factor corrections, switching mode power supplies, freewheeling diodes and secondary DC/DC rectification application.

FEATURES

- Very low profile - typical height of 1.1 mm
- Ideal for automated placement
- Oxide planar chip junction
- Ultrafast recovery time
- Soft recovery characteristics
- Low switching losses, high efficiency
- High forward surge capability
- Meets MSL level 1, per J-STD-020, LF maximum peak of 260 °C
- AEC-Q101 qualified
- Compliant to RoHS Directive 2002/95/EC and in accordance to WEEE 2002/96/EC
- Halogen-free according to IEC 61249-2-21 definition

AUTOMOTIVE
GRADE
Available



RoHS
COMPLIANT
HALOGEN
FREE

MECHANICAL DATA

Case: TO-277A (SMPC)

Molding compound meets UL 94 V-0 flammability rating
Base P/N-M3 - halogen-free, RoHS compliant, and commercial grade

Base P/NHM3 - halogen-free, RoHS compliant, and automotive grade

Terminals: Matte tin plated leads, solderable per J-STD-002 and JESD 22-B102

M3 suffix meets JESD 201 class 1A whisker test, HM3 suffix meets JESD 201 class 2 whisker test

MAXIMUM RATINGS ($T_C = 25$ °C unless otherwise noted)			
PARAMETER	SYMBOL	UH6PJ	UNIT
Device marking code		H6PJ	
Maximum repetitive peak reverse voltage	V_{RRM}	600	V
Maximum average forward rectified current (fig. 1)	$I_{F(AV)}$	6.0	A
Peak forward surge current 8.3 ms single half sine-wave superimposed on rated load	I_{FSM}	80	A
Operating junction and storage temperature range	T_J, T_{STG}	- 55 to + 175	°C

ELECTRICAL CHARACTERISTICS (T _C = 25 °C unless otherwise noted)						
PARAMETER	TEST CONDITIONS		SYMBOL	TYP.	MAX.	UNIT
Instantaneous forward voltage	I _F = 3.0 A	T _A = 25 °C	V _F ⁽¹⁾	1.6	-	V
	I _F = 6.0 A			1.9	3.0	
	I _F = 3.0 A	T _A = 125 °C		1.1	-	
	I _F = 6.0 A			1.3	1.8	
Reverse current	V _R = 600 V	T _A = 25 °C	I _R ⁽²⁾	-	10	μA
		T _A = 125 °C		46	200	
Maximum reverse recovery time	I _F = 0.5 A, I _R = 1.0 A, I _{rr} = 0.25 A		t _{rr}	23	25	ns
	I _F = 1.0 A, di/dt = 50 A/μs, V _R = 30 V, I _{rr} = 0.1 I _{RM}			33	45	
Typical softness factor (t _b /t _a)	I _F = 6 A, di/dt = 200 A/μs, V _R = 400 V, T _J = 125 °C		S	0.3	-	-
Typical reverse recovery current			I _{RM}	6.5	-	A
Typical stored charge			Q _{rr}	150	-	nC
Typical forward recovery time	I _F = 6 A, di/dt = 48 A/μs, V _F = 1.1 x V _F max.		t _{fr}	150	-	ns
Typical junction capacitance	4.0 V, 1 MHz		C _J	30	-	pF

Notes

(1) Pulse test: 300 μs pulse width, 1 % duty cycle

(2) Pulse test: Pulse width ≤ 40 ms

THERMAL CHARACTERISTICS (T _A = 25 °C unless otherwise noted)			
PARAMETER	SYMBOL	UH6PJ	UNIT
Typical thermal resistance	R _{θJA} ⁽¹⁾	90	°C/W
	R _{θJL} ⁽²⁾	5	

Notes

(1) Units mounted on recommended PCB 1 oz. pad layout

(2) With heatsink

ORDERING INFORMATION (Example)				
PREFERRED P/N	UNIT WEIGHT (g)	PREFERRED PACKAGE CODE	BASE QUANTITY	DELIVERY MODE
UH6PJ-M3/86A	0.10	86A	1500	7" diameter plastic tape and reel
UH6PJ-M3/87A	0.10	87A	6500	13" diameter plastic tape and reel
UH6PJHM3/86A ⁽¹⁾	0.10	86A	1500	7" diameter plastic tape and reel
UH6PJHM3/87A ⁽¹⁾	0.10	87A	6500	13" diameter plastic tape and reel

Note

(1) Automotive grade



RATINGS AND CHARACTERISTICS CURVES

($T_A = 25\text{ }^\circ\text{C}$ unless otherwise noted)

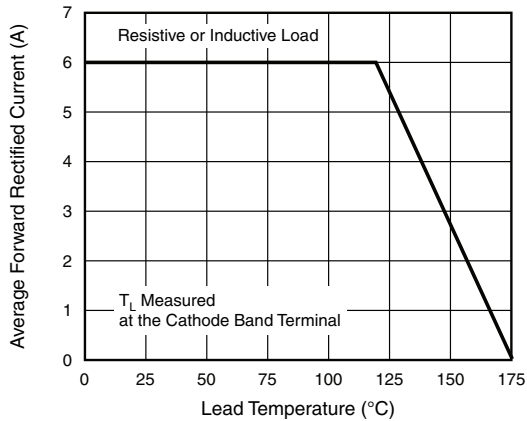

Fig. 1 - Maximum Forward Current Derating Curve

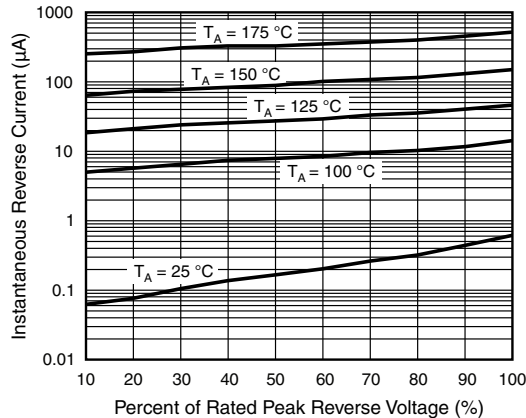

Fig. 4 - Typical Reverse Characteristics

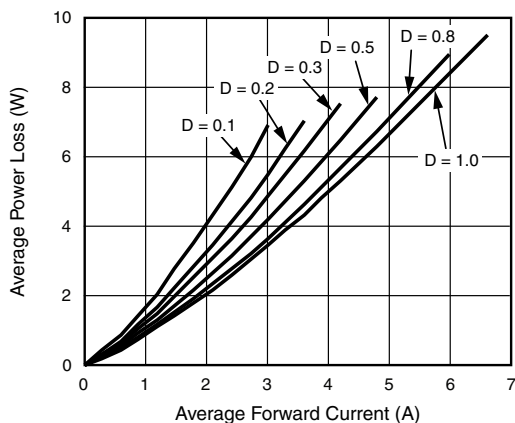

Fig. 2 - Forward Power Loss Characteristics

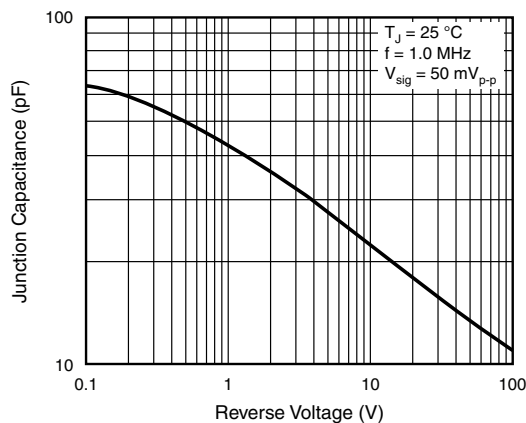

Fig. 5 - Typical Junction Capacitance

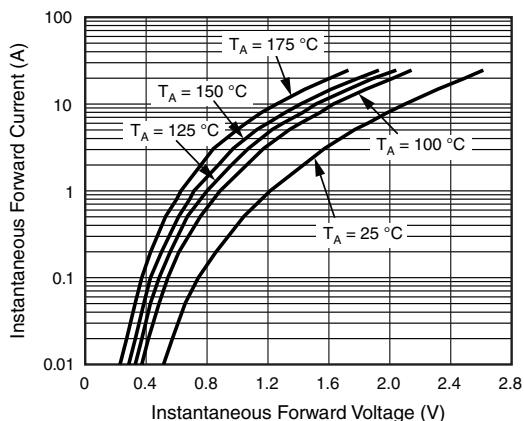
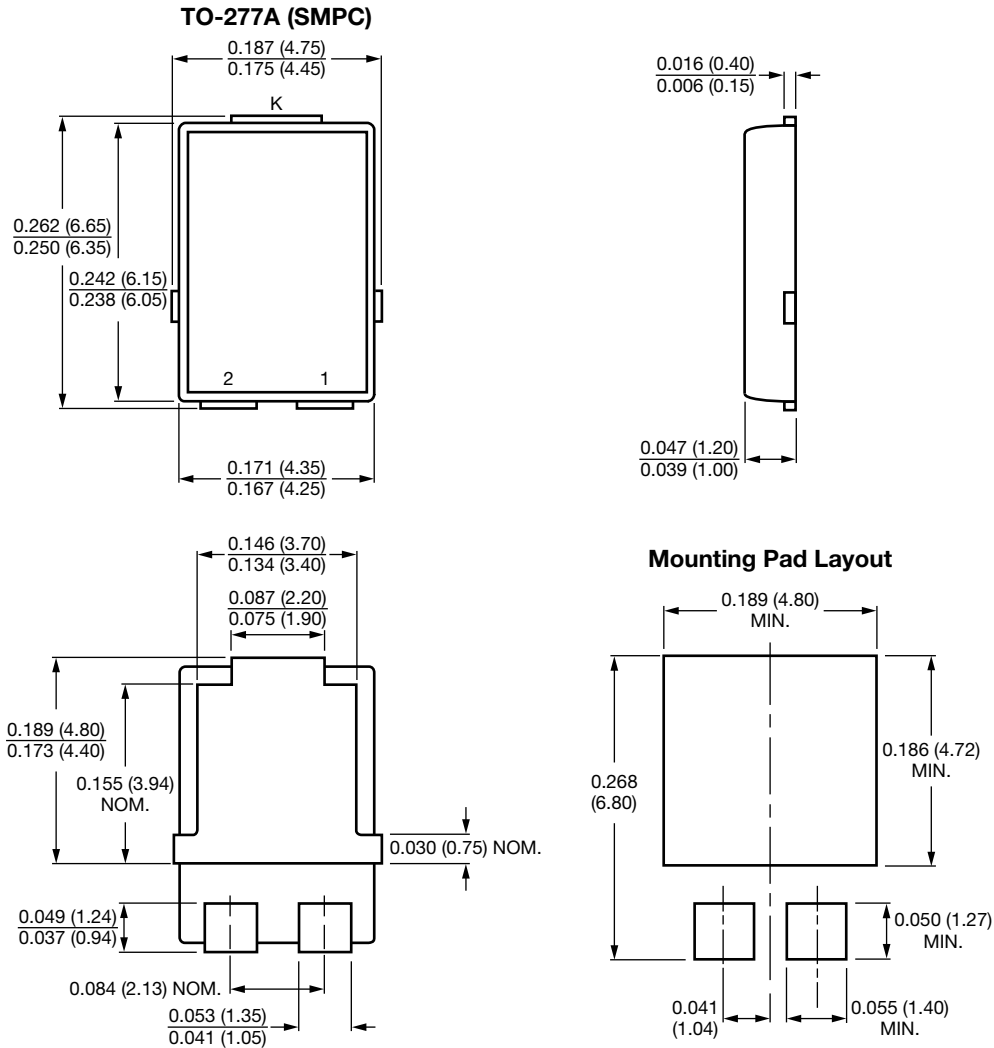

Fig. 3 - Typical Instantaneous Forward Characteristics

PACKAGE OUTLINE DIMENSIONS in inches (millimeters)



Conform to JEDEC TO-277A



Disclaimer

ALL PRODUCT, PRODUCT SPECIFICATIONS AND DATA ARE SUBJECT TO CHANGE WITHOUT NOTICE TO IMPROVE RELIABILITY, FUNCTION OR DESIGN OR OTHERWISE.

Vishay Intertechnology, Inc., its affiliates, agents, and employees, and all persons acting on its or their behalf (collectively, "Vishay"), disclaim any and all liability for any errors, inaccuracies or incompleteness contained in any datasheet or in any other disclosure relating to any product.

Vishay makes no warranty, representation or guarantee regarding the suitability of the products for any particular purpose or the continuing production of any product. To the maximum extent permitted by applicable law, Vishay disclaims (i) any and all liability arising out of the application or use of any product, (ii) any and all liability, including without limitation special, consequential or incidental damages, and (iii) any and all implied warranties, including warranties of fitness for particular purpose, non-infringement and merchantability.

Statements regarding the suitability of products for certain types of applications are based on Vishay's knowledge of typical requirements that are often placed on Vishay products in generic applications. Such statements are not binding statements about the suitability of products for a particular application. It is the customer's responsibility to validate that a particular product with the properties described in the product specification is suitable for use in a particular application. Parameters provided in datasheets and/or specifications may vary in different applications and performance may vary over time. All operating parameters, including typical parameters, must be validated for each customer application by the customer's technical experts. Product specifications do not expand or otherwise modify Vishay's terms and conditions of purchase, including but not limited to the warranty expressed therein.

Except as expressly indicated in writing, Vishay products are not designed for use in medical, life-saving, or life-sustaining applications or for any other application in which the failure of the Vishay product could result in personal injury or death. Customers using or selling Vishay products not expressly indicated for use in such applications do so at their own risk. Please contact authorized Vishay personnel to obtain written terms and conditions regarding products designed for such applications.

No license, express or implied, by estoppel or otherwise, to any intellectual property rights is granted by this document or by any conduct of Vishay. Product names and markings noted herein may be trademarks of their respective owners.

Material Category Policy

Vishay Intertechnology, Inc. hereby certifies that all its products that are identified as RoHS-Compliant fulfill the definitions and restrictions defined under Directive 2011/65/EU of The European Parliament and of the Council of June 8, 2011 on the restriction of the use of certain hazardous substances in electrical and electronic equipment (EEE) - recast, unless otherwise specified as non-compliant.

Please note that some Vishay documentation may still make reference to RoHS Directive 2002/95/EC. We confirm that all the products identified as being compliant to Directive 2002/95/EC conform to Directive 2011/65/EU.

Vishay Intertechnology, Inc. hereby certifies that all its products that are identified as Halogen-Free follow Halogen-Free requirements as per JEDEC JS709A standards. Please note that some Vishay documentation may still make reference to the IEC 61249-2-21 definition. We confirm that all the products identified as being compliant to IEC 61249-2-21 conform to JEDEC JS709A standards.