

# TVSA

## Transient voltage ESD suppressor

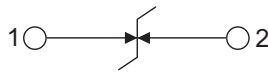
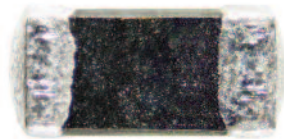

Surface Mount Device

Equivalent Circuits

### Applications

- Computers and peripherals
- Digital cameras
- Mobile phones
- DVD/Media Players
- MP3/Multimedia players
- A-V Equipment
- External storage
- DSL Modems
- Set top boxes
- Docking systems

### Product features

- Lead free, halogen free and RoHS compliant for global applications
- Single-line, bi-directional device for placement flexibility
- Silicon based chip
- Low capacitance to meet the needs for high speed single transient voltage protection
- Provides ESD protection with fast response time (<1ns) allowing equipment to pass IEC 61000-4-2 level 4 test
- Low profile designs for board space savings
- Low leakage current reduces power consumption
- Low clamping voltage
- Solid-state silicon-avalanche technology

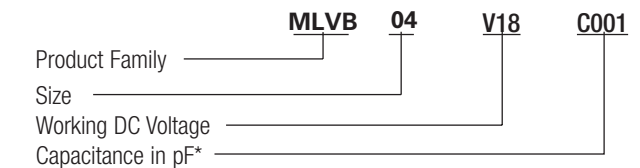

\* Part numbers use "R" to denote decimal point for decimal values of pico farads.

### Packaging

- Size 0402: 10,000 pieces per reel - EIA (EIAJ)
- Size 0603: 4000 pieces per reel - EIA (EIAJ)

Specifications							
Part Number	Size	Stand-Off Voltage	Breakdown Voltage	Clamping Voltage At $I_{peak} = 1A$	Capacitance pF	ESD Air/Contact (kV)	Leakage Current (typical)
TVSA02V05C004	0201	5	10	17	4	15/8	< 10nA
TVSA04V05C006	0402	5	10	17	6	15/8	< 10nA

Stand-off Voltage - Maximum DC operating voltage the diode can maintain and not exceed 1mA leakage current. Breakdown Voltage - Measured at any I/O pin to ground at 1mA DC current.  
Clamping Voltage - Maximum peak voltage across the diode with 8/20ms waveform and 1A pulse current.  
Capacitance - Device capacitance measured with zero volt bias at 1MHz.  
ESD Air/Contact - Voltages tested to IEC 61000-4-2.



Powering Business Worldwide

**Dimensions - mm**

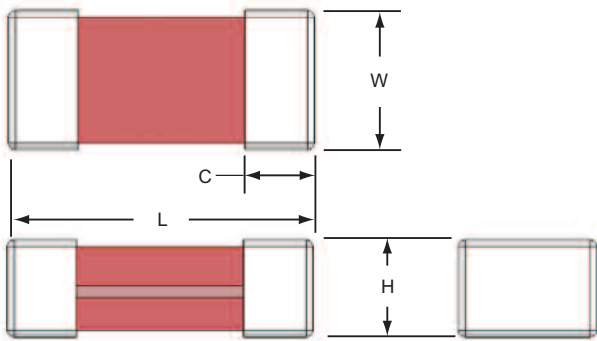

Size	L	W	H	C
0201	0.60±0.05	0.30±0.05	0.30±0.05	0.20±0.10
0402	1.00±0.15	0.50±0.10	0.50±0.10	0.25±0.15

**Recommended Pad Layout - mm (in)**

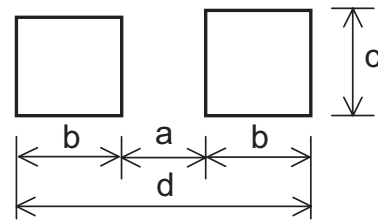

Size	a	b	c	d
0201	0.23 (0.009)	0.30 (0.012)	0.45 (0.018)	0.83 (0.033)
0402	0.51 (0.020)	0.61 (0.024)	0.51 (0.020)	1.70 (0.067)

**Tape Packaging Specifications - mm**

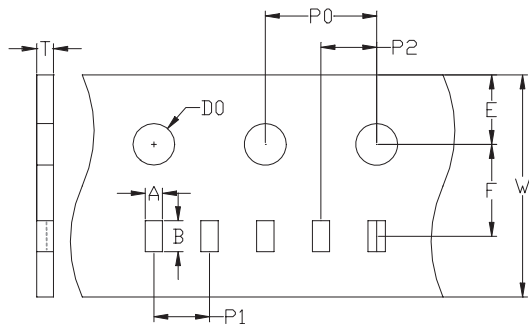

0201 Carrier Dimensions									
A	B	W	E	F	P0	P1	P2	D0	T
0.37 ±0.03	0.69 ±0.03	8.0 ±0.1	1.75 ±0.05	3.5 ±0.05	4.0 ±0.1	2.0 ±0.05	2.0 ±0.05	1.55 ±0.05	0.42 ±0.03
0402 Carrier Dimensions									
0.58 ±0.03	1.2 ±0.03	8.0 ±0.1	1.75 ±0.05	3.5 ±0.05	4.0 ±0.1	2.0 ±0.05	2.0 ±0.05	1.55 ±0.05	0.60 ±0.03

**Soldering Recommendations**

- Compatible with lead and lead-free solder reflow processes
- Peak reflow temperatures and durations:
  - IR Reflow = 260°C max for 30 sec. max.
  - Wave Solder = 260°C max. for 10 sec. max.
- Recommended IR Reflow Profile:

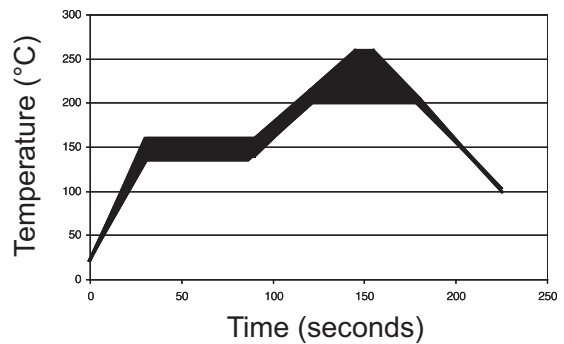

Life Support Policy: Eaton does not authorize the use of any of its products for use in life support devices or systems without the express written approval of an officer of the Company. Life support systems are devices which support or sustain life, and whose failure to perform, when properly used in accordance with instructions for use provided in the labeling, can be reasonably expected to result in significant injury to the user.

Eaton reserves the right, without notice, to change design or construction of any products and to discontinue or limit distribution of any products. Eaton also reserves the right to change or update, without notice, any technical information contained in this bulletin.

**Eaton**  
Electronics Division  
1000 Eaton Boulevard  
Cleveland, OH 44122  
United States  
www.eaton.com/electronics

© 2017 Eaton  
All Rights Reserved Printed in USA  
Publication No. DS4072 BU-SB13279  
June 2017