

## SMOV<sup>®</sup>34S Varistor Series

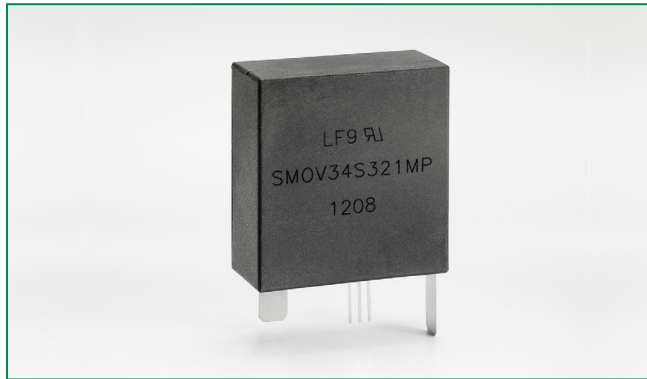

### Agency Approvals

Agency	Agency Approval	Agency File Number
	UL1449	E320116

### Additional Information



Datasheet



Resources



Samples

### Description

The Littelfuse SMOV<sup>®</sup>34S thermally protected varistor is a self-protected device. It consists of a 34mm square varistor with an integral thermal disconnect designed to open in the event of overheating due to abnormal overvoltage as outlined in UL1449. The SMOV<sup>®</sup> helps facilitate SPD module compliance to UL1449 and offers quick thermal response due to the close proximity of the integrated thermal element to the MOV body. This configuration also offers lower inductance than most discreet solutions resulting in improved clamping performance to fast over voltage transients.

The device has a separate micro-switch, which can be used to indicate that the MOV has been disconnected from the circuit. This separate switch makes the monitoring circuitry completely isolated from the main power which ensures indicator circuit safety and simplifies the customers circuit design.

### Features

- Maximum single surge capability 40 kA, 8/20 waveshape.
- Nominal Discharge Current Value: 20kA.
- Intermediate current rating: 50A/150A.
- -45°C to +75°C operating temperature.
- Recognized to UL 1449.
- Lead-Free and RoHS compliant.
- Integrated micro-switch for indication circuitry/design.

### Applications

- SPD applications
- AC/DC distribution
- T/Data center
- Power supplier
- Telecommunication

### Absolute Maximum Ratings

• For ratings of individual members of a series, see Device Ratings and Specifications chart

	SMOV34S S Varistor Series	Units
<b>Continuous:</b>		
<b>Steady State Applied Voltage:</b>		
DC Voltage Range (VM(DC))	150 to 970	V
AC Voltage Range (V <sub>M(AC)RMS</sub> )	115 to 750	V
<b>Transient:</b>		
Non-Repetitive Surge Current, 8/20μs Waveform (I <sub>TM</sub> )	40,000	A
Non-Repetitive Energy Capability, 2ms Waveform (W <sub>TM</sub> )	280 to 1200	J
Operating Ambient Temperature Range (T <sub>A</sub> )	-45 to +75	°C
Storage Temperature Range (T <sub>STG</sub> )	-45 to +85	°C
Hi-Pot Encapsulation (Isolation Voltage Capability)	2500	V
Isolation Voltage Capability (when the thermal disconnect opens)	1500	V
Housing Insulation Resistance	>1,000	MΩ

*CAUTION: Stresses above those listed in "Absolute Maximum Ratings" may cause permanent damage to the device. This is a stress only rating and operation of the device at these or any other conditions above those indicated in the operational sections of this specification is not implied.*

### Device Ratings & Specifications

Part Number	Maximum Rating (75°C)					Specifications (25 °C)				
	Continuous		Transient			Varistor Voltage at 1mA Test Current		Maximum Clamping Voltage 8/20µs		Typical Capacitance f = 1MHz
	AC Volts	DC Volts	Energy 2ms	Peak Surge Current 8/20µs	Nominal Discharge Current					
	$V_{M(IAC)_{RMS}}$	$V_{M(DC)}$	$W_{TM}$	$I_{TM}$ 1 x Pulse	$I_n$	$V_{N(DC)_{Min}}$	$V_{N(DC)_{Max}}$	$V_c$	$I_{PK}$	$C$
(V)	(V)	(J)	(A)	(A)	(V)		(V)	(A)	(pF)	
SMOV34S111MP	115	150	280	40000	20000	162	198	305	200	11500
SMOV34S111NP										
SMOV34S131MP	130	175	310	40000	20000	184.5	225.5	345	200	10000
SMOV34S131NP										
SMOV34S151MP	150	200	360	40000	20000	216	264	405	200	8000
SMOV34S151NP										
SMOV34S181MP	180	240	400	40000	20000	256	312	488	200	6800
SMOV34S181NP										
SMOV34S251MP	250	320	490	40000	20000	351	429	650	200	5000
SMOV34S251NP										
SMOV34S271MP	275	350	550	40000	20000	387	473	730	200	4500
SMOV34S271NP										
SMOV34S301MP	300	385	590	40000	20000	432	528	780	200	4050
SMOV34S301NP										
SMOV34S321MP	320	420	640	40000	20000	459	561	830	200	3800
SMOV34S321NP										
SMOV34S421MP	420	560	910	40000	20000	612	748	1130	200	3000
SMOV34S421NP										
SMOV34S461MP	460	610	960	40000	10000	643.5	786.5	1188	200	2800
SMOV34S461NP										
SMOV34S511MP	510	675	960	40000	10000	738	902	1350	200	2500
SMOV34S511NP										
SMOV34S551MP	550	700	965	40000	10000	770	939	1415	200	2250
SMOV34S551NP										
SMOV34S621MP	620	800	1010	40000	10000	900	1100	1625	200	2100
SMOV34S621NP										
SMOV34S751MP	750	970	1200	40000	10000	1080	1320	2000	200	1800
SMOV34S751NP										

Average power dissipation of transients should not exceed 2.0 watts

Same ratings and specifications apply to Non Isolated Monitored Switch alternative design. Replace "M" with "N" in the part number. e.g.: SMOV34S111NP.

Refer to Part Number System at the end of this document.

### Thermal Characteristics

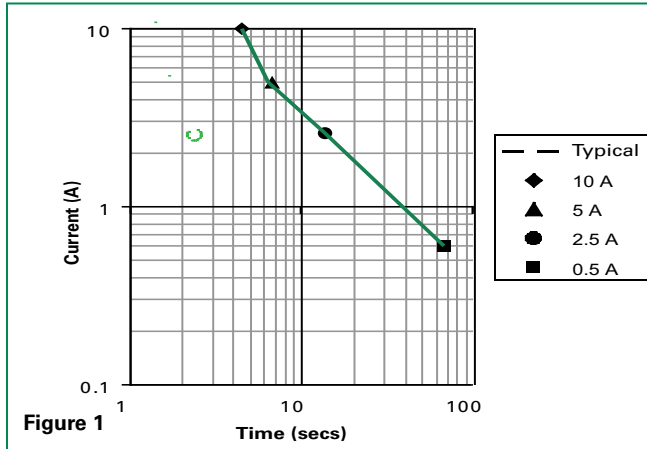

### Peak Current & Energy Derating Curve

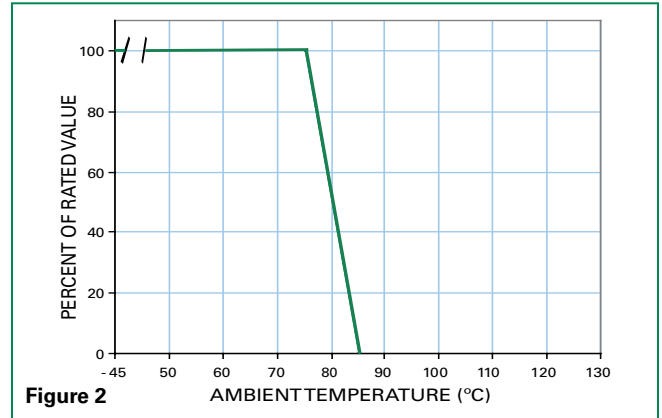

For applications exceeding 75°C ambient temperature, the peak surge current and energy ratings must be reduced as shown.

### Pulse Rating Curve

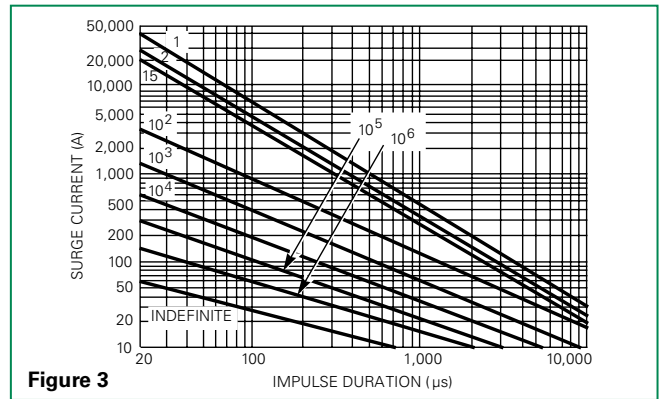

### Transient V-I Characteristic Curve

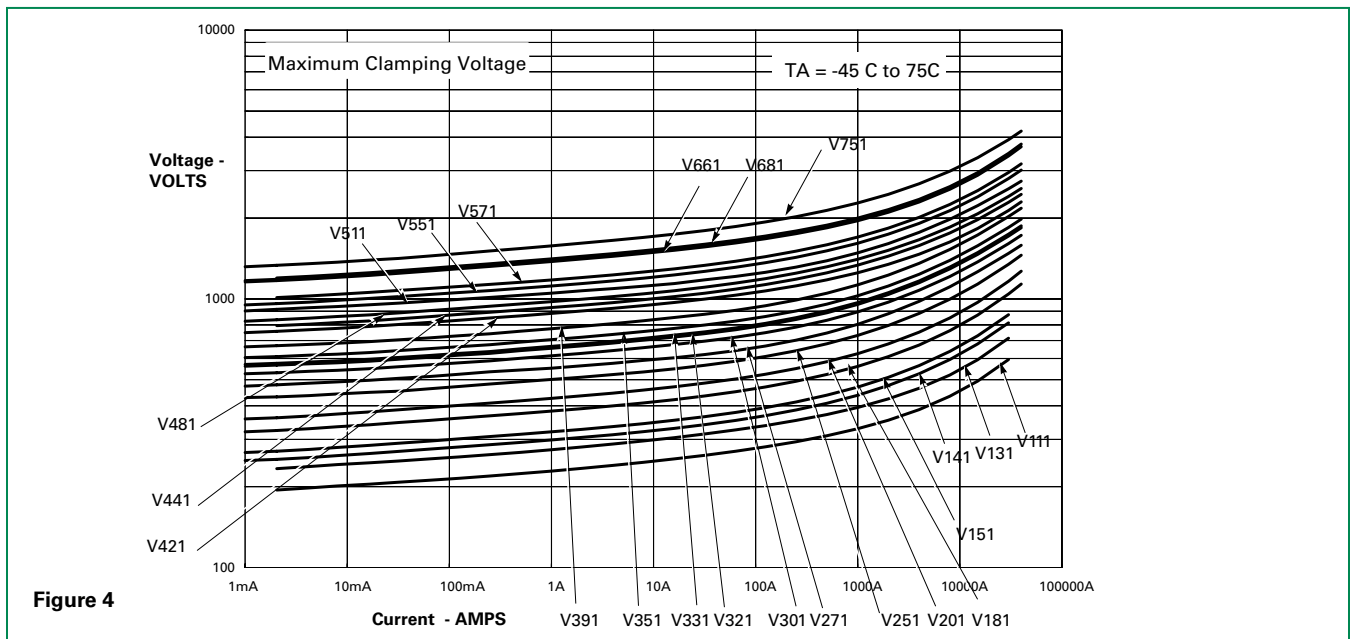

### Wave Solder Profile

Because the SMOV®34S varistors contain a thermal protection device, care must be taken when soldering the devices into place. Two soldering methods are possible. Firstly, hand soldering: It is

recommended to heat-sink the leads of the device. Secondly, wave-soldering: It is critically important that all preheat stage and the solder bath temperatures are rigidly controlled.

### Non Lead-free Profile

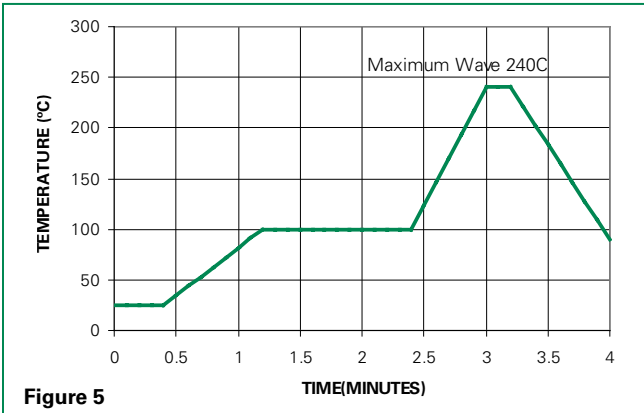

Figure 5

### Lead-free Profile

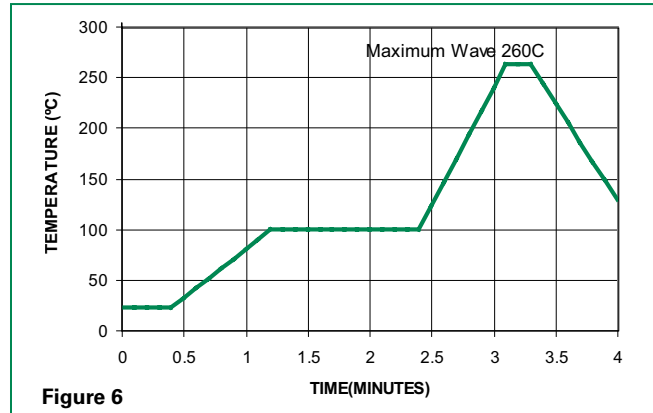

Figure 6

### Physical Specifications

<b>Lead Material</b>	Tin-plated Copper
<b>Soldering Characteristics</b>	Solderability per MIL-STD-202, Method 208
<b>Insulating Material</b>	Cured, flame retardant epoxy polymer meets UL94V-0 requirements.
<b>Device Labeling</b>	Marked with LF, part identifier, and date code

### Environmental Specifications

<b>Operating/Storage Temperature</b>	-45°C to +75°C/ -45°C to +85°C
<b>Humidity Aging</b>	+75°C, 85% RH, 1000 hours +/-10% voltage
<b>Thermal Shock</b>	+75°C to -40°C 5 times +/-10% voltage
<b>Solvent Resistance</b>	MIL-STD-202, Method 215
<b>Moisture Sensitivity</b>	Level 1, J-STD-020

### Part Numbering System

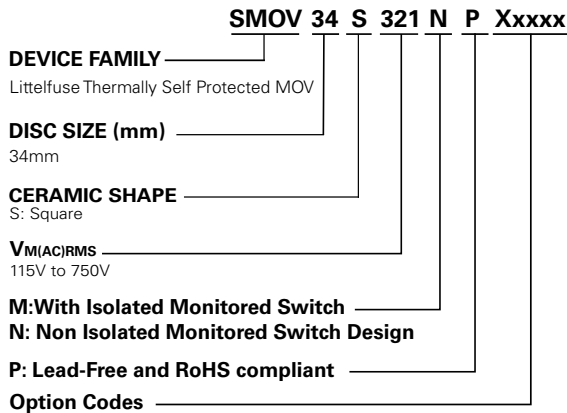

### Part Marking System

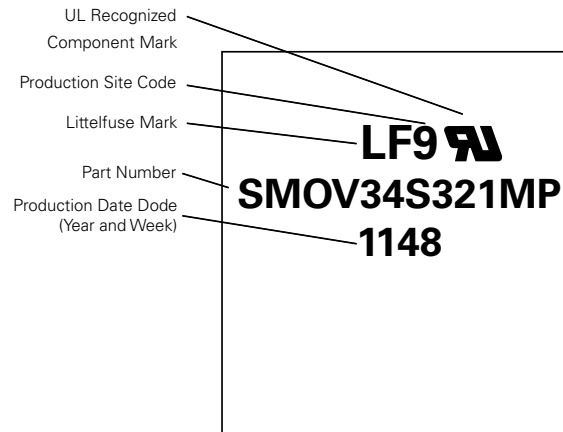

### Device Dimension

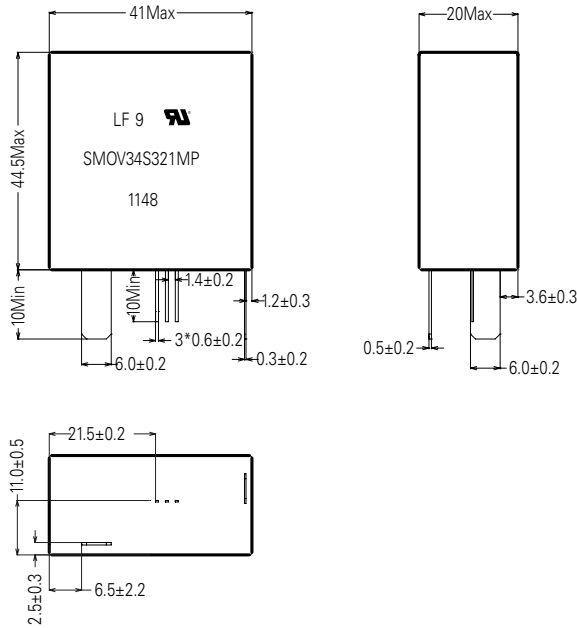

### Lead Configuration

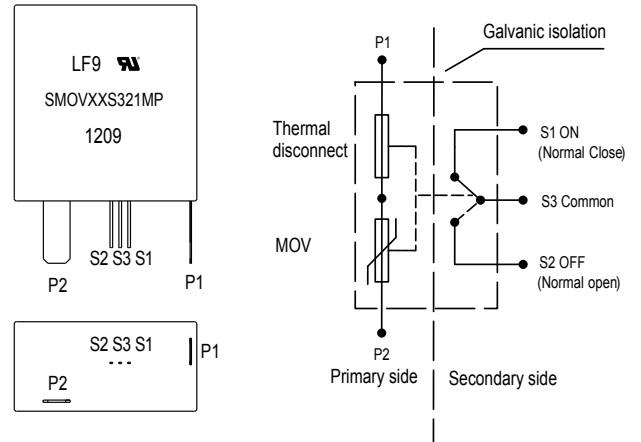

### Application Example

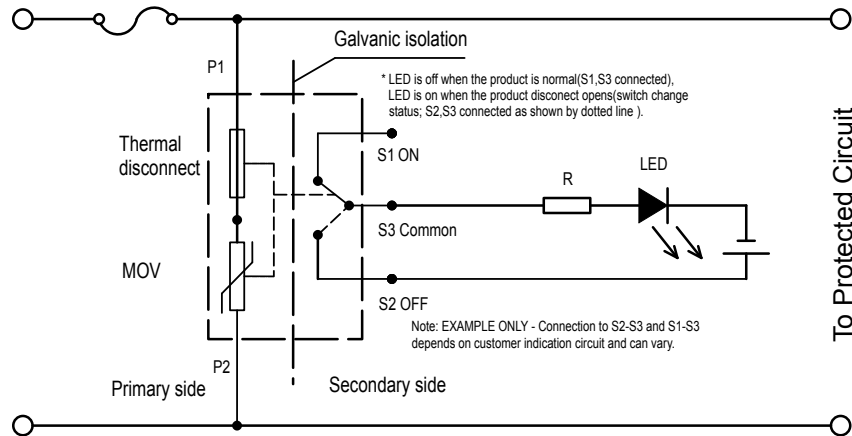

### Switch Specification

SMOV Switch	Voltage DC	Current (Amps)	Contact Resistance Max.	Insulation Resistance Min.	Dielectric Strength 0.5mA/Minute
Switch	12V	0.1A	70mΩ	100MΩ	500VAC

**Disclaimer Notice - Information furnished is believed to be accurate and reliable. However, users should independently evaluate the suitability of and test each product selected for their own applications. Littelfuse products are not designed for, and may not be used in, all applications. Read complete Disclaimer Notice at [www.littelfuse.com/disclaimer-electronics](http://www.littelfuse.com/disclaimer-electronics).**