

4V Drive Nch MOSFET

RSD050N06

●Structure

Silicon N-channel MOSFET

●Features

- 1) Low on-resistance.
- 2) Fast switching speed.
- 3) Drive circuits can be simple.
- 3) Parallel use is easy.

●Applications

Switching

●Packaging specifications

Type	Package	CPT3
	Code	TL
	Basic ordering unit (pieces)	2500

●Absolute maximum ratings (T_a=25°C)

Parameter	Symbol	Limits	Unit
Drain-source voltage	V _{DSS}	60	V
Gate-source voltage	V _{GSS}	±20	V
Drain current	Continuous	I _D	±5.0 A
	Pulsed	I _{DP} *1	±15 A
Source current (Body Diode)	Continuous	I _S	5.0 A
	Pulsed	I _{SP} *1	15 A
Power dissipation	P _D *2	15	W
Channel temperature	T _{ch}	150	°C
Range of storage temperature	T _{stg}	-55 to +150	°C

*1 Pw≤10μs, Duty cycle≤1%

*2 T_c=25°C

●Thermal resistance

Parameter	Symbol	Limits	Unit
Channel to Case	R _{th(ch-c)} *	8.33	°C / W

* T_c=25°C

●Dimensions (Unit : mm)

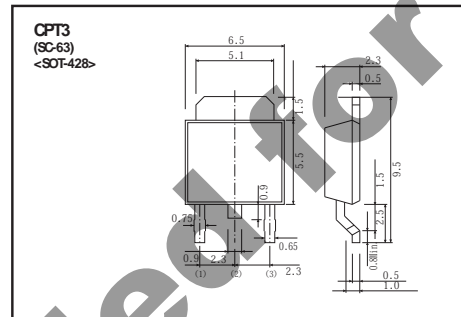

●Inner circuit

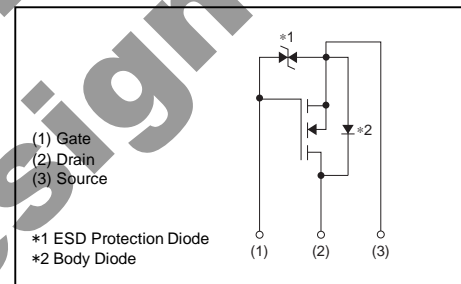

●Electrical characteristics (T_a=25°C)

Parameter	Symbol	Min.	Typ.	Max.	Unit	Conditions
Gate-source leakage	I _{GSS}	-	-	±10	μA	V _{GS} =±20V, V _{DS} =0V
Drain-source breakdown voltage	V _{(BR)DSS}	60	-	-	V	I _D =1mA, V _{GS} =0V
Zero gate voltage drain current	I _{DSS}	-	-	1	μA	V _{DS} =60V, V _{GS} =0V
Gate threshold voltage	V _{GS(th)}	1.0	-	3.0	V	V _{DS} =10V, I _D =1mA
Static drain-source on-state resistance	R _{DS(on)} *	-	78	109	mΩ	I _D =5.0A, V _{GS} =10V
		-	94	131		I _D =5.0A, V _{GS} =4.5V
		-	100	140		I _D =5.0A, V _{GS} =4.0V
Forward transfer admittance	Y _{fs} *	3.5	-	-	S	I _D =5.0A, V _{DS} =10V
Input capacitance	C _{ISS}	-	290	-	pF	V _{DS} =10V
Output capacitance	C _{OSS}	-	90	-	pF	V _{GS} =0V
Reverse transfer capacitance	C _{RSS}	-	35	-	pF	f=1MHz
Turn-on delay time	t _{d(on)} *	-	8	-	ns	I _D =2.5A, V _{DD} =30V
Rise time	t _r *	-	17	-	ns	V _{GS} =10V
Turn-off delay time	t _{d(off)} *	-	26	-	ns	R _L =12Ω
Fall time	t _f *	-	8	-	ns	R _G =10Ω
Total gate charge	Q _g *	-	8.0	-	nC	V _{DD} =30V
Gate-source charge	Q _{gs} *	-	1.4	-	nC	I _D =5.0A
Gate-drain charge	Q _{gd} *	-	1.4	-	nC	V _{GS} =10V

*Pulsed

●Body diode characteristics (Source-Drain) (T_a=25°C)

Parameter	Symbol	Min.	Typ.	Max.	Unit	Conditions
Forward Voltage	V _{SD} *	-	-	1.2	V	I _s =5.0A, V _{GS} =0V

*Pulsed

●Electrical characteristic curves (Ta=25°C)

Fig.1 Typical Output Characteristics (I)

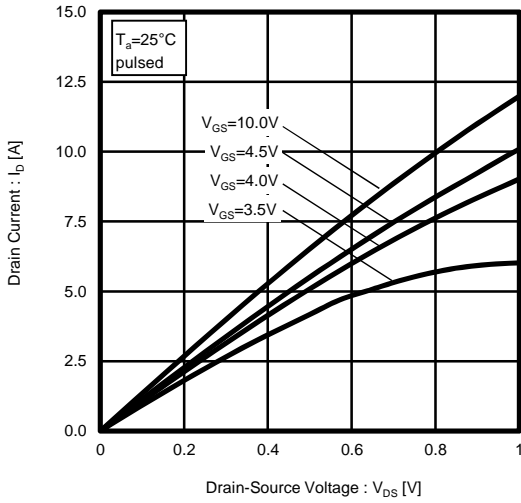

Fig.2 Typical Output Characteristics (II)

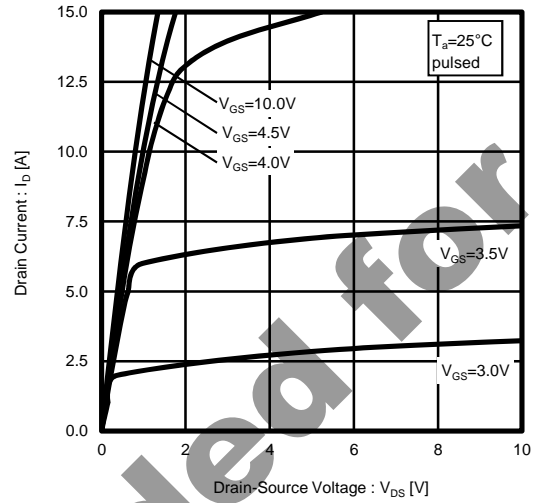

Fig.3 Static Drain-Source On-State Resistance vs. Drain Current

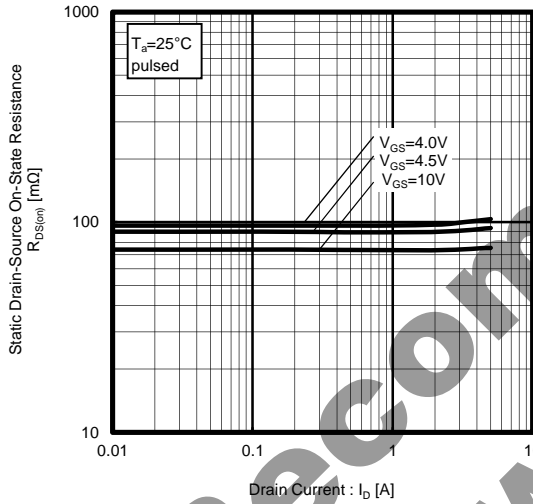

Fig.4 Static Drain-Source On-State Resistance vs. Drain Current

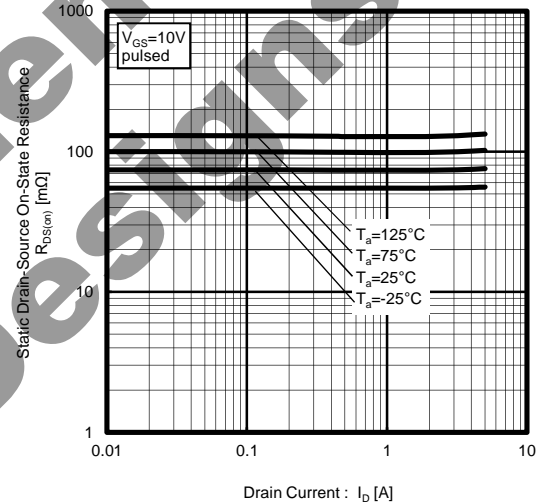

Fig.5 Static Drain-Source On-State Resistance vs. Drain Current

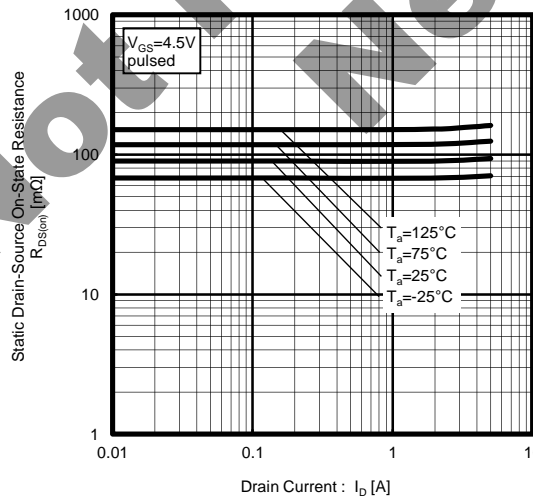

Fig.6 Static Drain-Source On-State Resistance vs. Drain Current

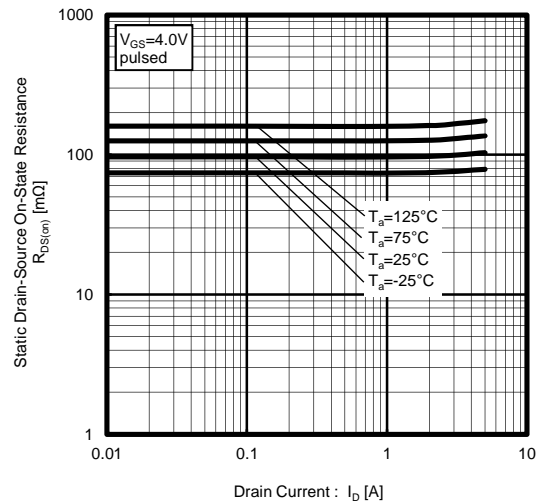

Fig.7 Forward Transfer Admittance vs. Drain Current

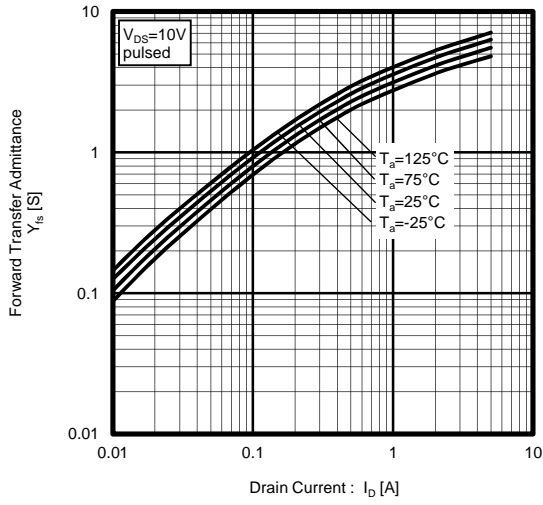

Fig.8 Typical Transfer Characteristics

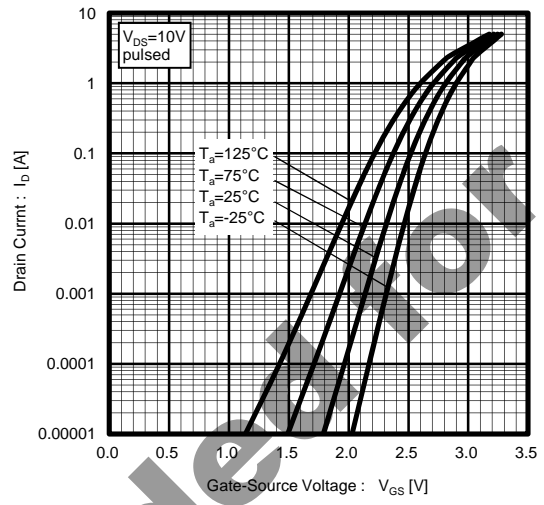

Fig.9 Source Current vs. Source-Drain Voltage

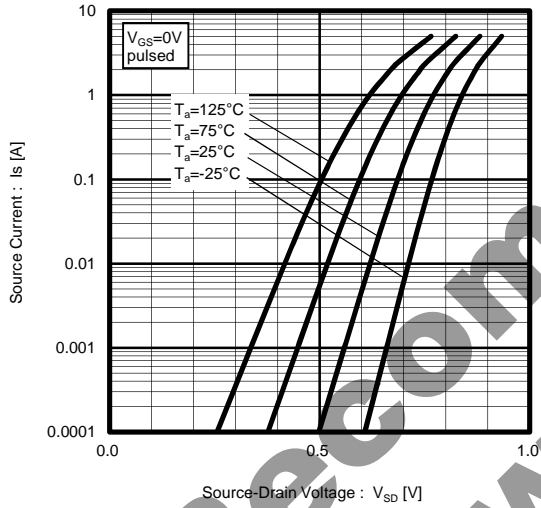

Fig.10 Static Drain-Source On-State Resistance vs. Gate-Source Voltage

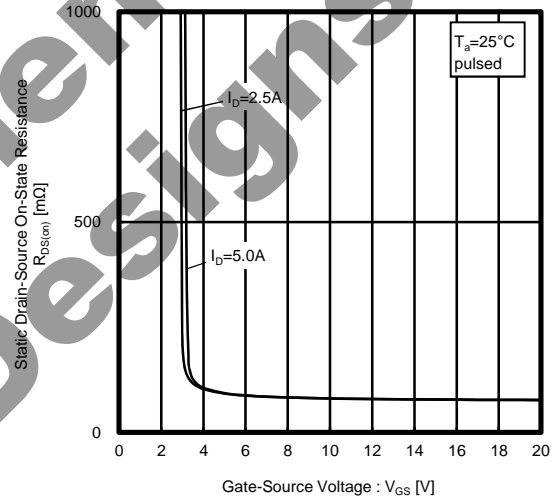

Fig.11 Switching Characteristics

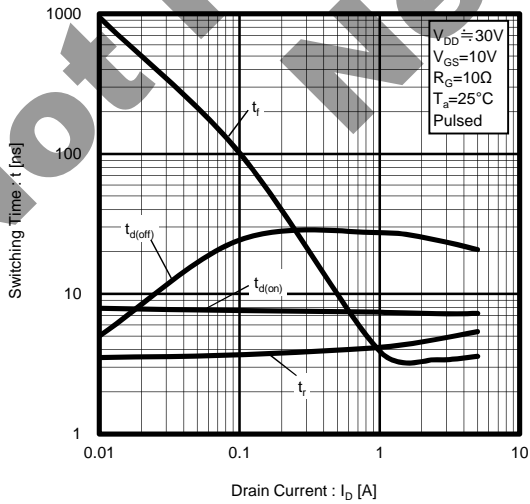

Fig.12 Dynamic Input Characteristics

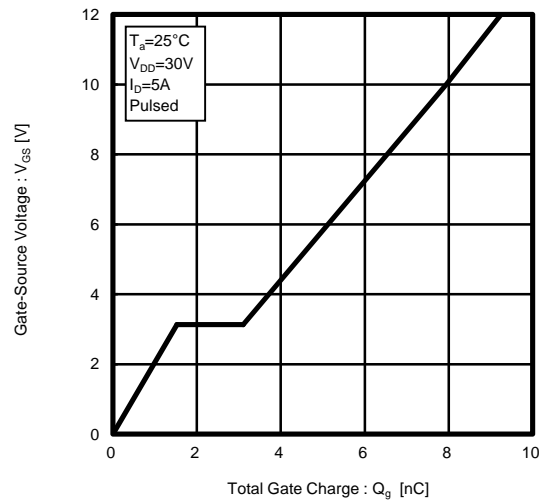

Fig.13 Typical Capacitance vs. Drain-Source Voltage

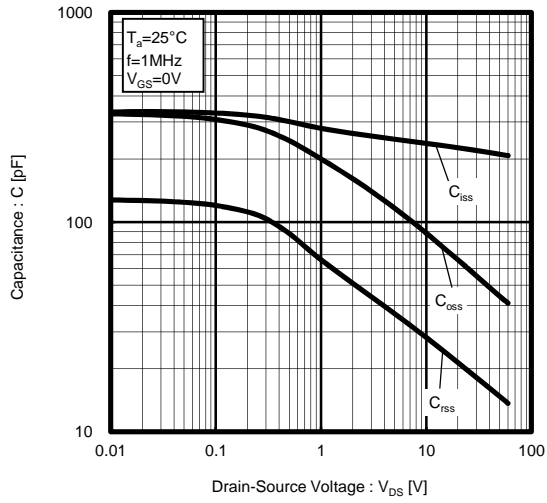

Fig.14 Maximum Safe Operating Area

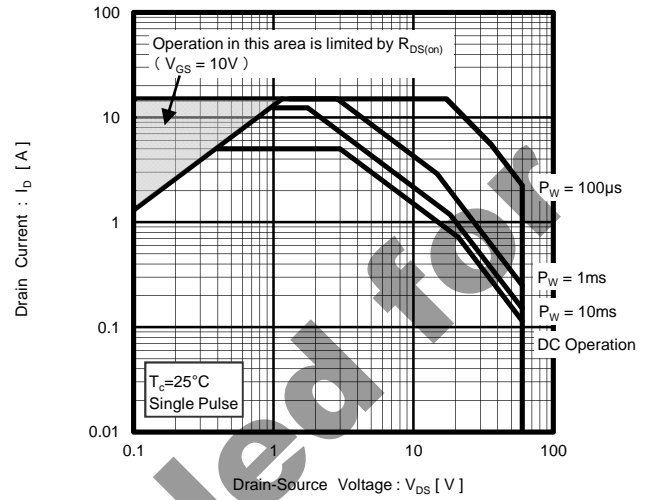
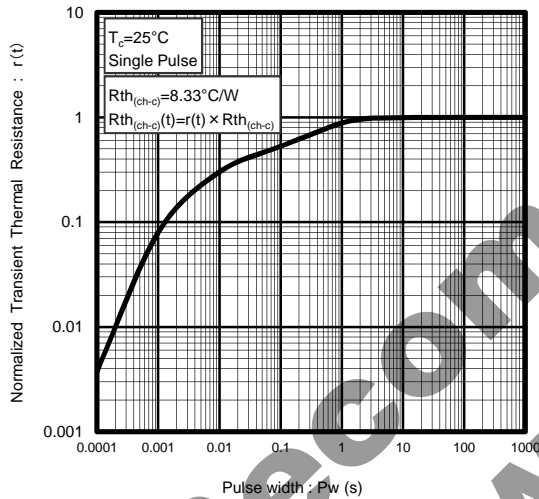

Fig.15 Normalized Transient Thermal Resistance v.s. Pulse Width



Not Recommended for New Designs

●Measurement circuits

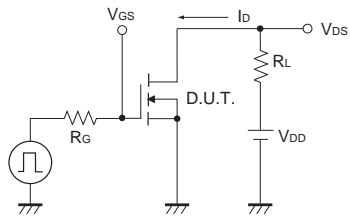

Fig.1-1 Switching Time Measurement Circuit

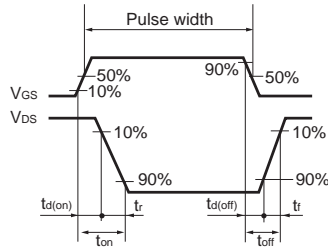

Fig.1-2 Switching Waveforms

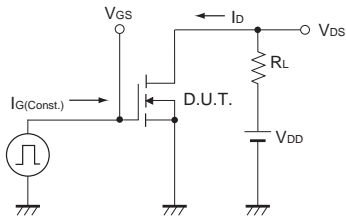

Fig.2-1 Gate Charge Measurement Circuit

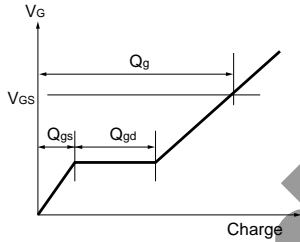

Fig.2-2 Gate Charge Waveform

Not Recommended for New Designs