

FEATURES

- 240 Watts total output power, fixed 12 VDC @ 20 A
- 94.5% ultra-high efficiency at full load with regulation
- 36 to 75 Volt DC input range (48 VDC nominal)
- Standard eighth-brick footprint
- 0.4-inch (10.2 mm) low height (no baseplate)
- Synchronous rectifier topology with 100 mV (typ.) ripple & noise
- Up to +85° Celsius thermal performance (with derating)
- Stable no-load operation
- Fully isolated to 2250 VDC (BASIC)
- Remote On/Off enable control
- Extensive protection features – SC, OC, UVLO, OT
- Certified to safety, emissions and environmental standards
- Meets UL 60950-1, CAN/CSAC22.2 No. 60950-1, IEC60950-1, EN60950-1 safety approvals (2nd Edition)

PRODUCT OVERVIEW

The fully isolated (2250 Vdc) RBE-12/20-D48 series accept a 36 to 75 Volt DC input voltage range (48 VDC nominal) and converts it to a fixed 12Vdc output. Applications include 48V-powered datacom and telecom installations, base stations, cellular dataphone repeaters, instruments and embedded systems. Wideband output ripple and noise is a low 100 mV (typical), peak-to-peak. Reduced open frame overall height of 0.4" (10.2 mm) fits tight card cages.

The RBE's regulated synchronous-rectifier topology and fixed frequency operation means excellent efficiencies up to 94.5%, enabling "no heatsink" operation for most applications up to

+85° Celsius (see derating curves). "No fan" or zero airflow higher temperature applications may use the optional base plate for cold plate mounting or natural-convection heatsinks.

Electronic protection features include input undervoltage lockout (UVLO), output current limit, short circuit hiccup, and overtemperature shut-down. Available options include positive or negative logic On/Off control, conformal coating, various pin lengths, and the baseplate. Assembled using ISO-certified automated surface-mount techniques, the RBE series is certified to UL and IEC safety standards.

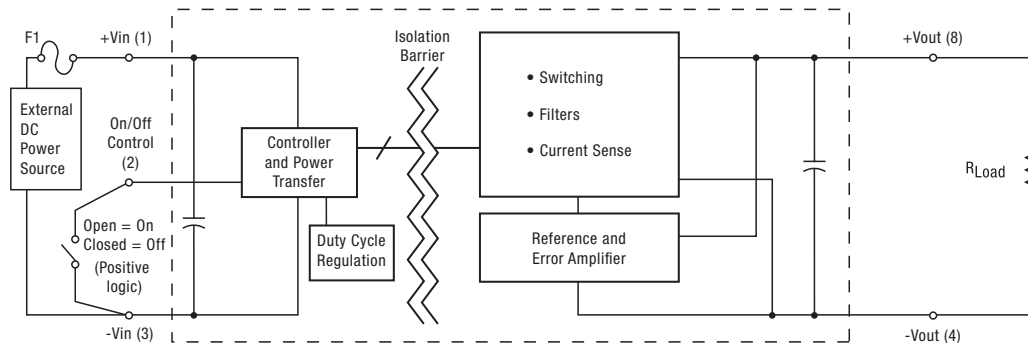

Figure 1. Connection Diagram

Typical topology is shown. Murata Power Solutions recommends an external fuse at F1.



PERFORMANCE SPECIFICATIONS SUMMARY AND ORDERING GUIDE														
Root Model ①	Output						Input				Efficiency		Package	
	V _{OUT} (V)	I _{OUT} (A, max)	Total Power (W)	Ripple & Noise (mVp-p)	Regulation (max.) ②		V _{IN} Nom. (V)	Range (V)	I _{IN, min. load} (mA)	I _{IN, full load} (A)	Min.	Typ.	Case (inches)	Case (mm)
				Typ.	Line (%)	Load (%)								
RBE-12/20-D48	11.7	20	234	100	±2	±3	48	36-75	80	5.16	91%	94.5%	2.3x0.9x0.4	58.4x22.9x10.16

- ① Please refer to the part number structure for additional options and complete ordering part numbers.
- ② Line regulation is given as V_{in} = 40V to 75V, I_{out} = half load. Load regulation is V_{in} = 48V, I_{out} = I_{min} to I_{max}.
- ③ All specifications are at the full input voltage range, maximum load, and full temperature range unless otherwise noted. See detailed specifications. Output capacitors are 1 μF in parallel with 10 μF and 470μF capacitor across the input pins. I/O caps are necessary for our test equipment and may not be needed for your application.

PART NUMBER STRUCTURE

R BE - 12 / 20 - D48 N M B H Lx - C

Output Configuration:

- R** = Regulated

Eighth-Brick Package
Isolated converter

Nominal Output Voltage

Maximum Rated Output
Current in Amps

Input Voltage Range
D48 = 36-75V,
48V nominal

On/Off Control Logic
N = Negative logic
P = Positive logic

RoHS Hazardous Substance Compliance
(does not claim EU RoHS exemption 7b—lead in solder)
C = RoHS-6

Pin Length Option (Through-hole packages only)
Blank = Standard pin length 0.180 inches (4.6mm)
L1 = Pin length 0.110 inches (2.79mm) ①
L2 = Pin length 0.145 inches (3.68mm) ①

Conformal coating (optional)
Blank = no coating, standard
H = Coating added, optional ①

Baseplate
Blank = No baseplate
B = Baseplate installed ②

Surface Mount
Blank = Thru-hole pin mount
M = Surface mount (MSL rating 1) ③

- ① Special quantity order is required; samples available with standard pin length only.
- ② SMT (M) models are not available with a baseplate.
- ③ SMT (M) versions are not available in sample quantities.
- ④ Some model number combinations may not be available. See website or contact your local Murata sales representative.

FUNCTIONAL SPECIFICATIONS

ABSOLUTE MAXIMUM RATINGS	Conditions ①	Minimum	Typical/Nominal	Maximum	Units
Input Voltage, Continuous	Full power operation, full temperature range	0		80	Vdc
Input Voltage, Transient	Operating or non-operating, tested: 100 mS max. duration	0		100	Vdc
Isolation Voltage	Input to output			2250	Vdc
Input Reverse Polarity	None, install external fuse		None		Vdc
On/Off Remote Control	Power on or off, referred to -Vin	0		15	Vdc
Output Power		0		237.51	W
Output Current	Current-limited, no damage, short-circuit protected	0		20	A
Operating Ambient Temperature Range	With derating	-40		85	°C
Absolute maximums are stress ratings. Exposure of devices to greater than any of these conditions may adversely affect long-term reliability. Proper operation under conditions other than those listed in the Performance/Functional Specifications Table is not implied nor recommended.					
INPUT	Conditions ① ③				
Operating voltage range		36	48	75	Vdc
Voltage Transient (100ms duration)				100	Vdc
Recommended External Fuse	Fast blow		15		A
Start-up threshold	Rising input voltage	32	33	34	Vdc
Undervoltage lockout	Falling input voltage	30	31	32	Vdc
Reverse Polarity Protection	None, install external fuse		None		Vdc
Internal Filter Type			Pi		
Input current					
Full Load Conditions			5.16	5.44	A
Low Line	Vin = minimum		6.99	7.33	A
Inrush Transient	Vin = 48V			0.05	A ² -Sec.
Short circuit Input current			150	800	mA
No Load Input Current	Iout = minimum, unit = ON, Vin = 48V		80	150	mA
Shut-Down Mode Input Current (Off, UV, OT)			5	10	mA
Reflected (back) ripple current ②	Measured at input with specified filter		70	200	mA, pk-pk
Pre-biased startup	External voltage < Vset	0	Monotonic		V
GENERAL and SAFETY					
Efficiency	Vin = 48V	91	94.5		%
	Vin = 75V	90	93		%
Isolation					
Isolation Voltage – no baseplate	Input to output, continuous	2250			Vdc
Isolation Voltage – with baseplate	Input to output, continuous	2250			Vdc
Isolation Voltage, Input to baseplate			1500		Vdc
Isolation Voltage, Output to baseplate			1500		Vdc
Insulation Safety Rating			basic		
Isolation Resistance			10		Mohm
Isolation Capacitance			1500		pF
Safety	Certified to UL-60950-1, CSA-C22.2 No.60950-1, IEC/EN60950-1, 2nd Edition		Yes		
Calculated MTBF	Per Telcordia SR332, issue 2, Method 1, Class 1, GF Tambient = +25C		2.1		Hours x 10 ⁶
DYNAMIC CHARACTERISTICS					
Fixed Switching Frequency			200		KHz
Startup Delay	Power ON 10% Vout to 90% Vout (50% resistive load)			15	mS
Rise time	Remote ON to 10% Vout, Vin = 48V (50% resistive load)			15	mS
Dynamic Load Response	50-75-50% load step, settling time to within ±1% of Vout. (48Vin, 470uF output capacitance, 1A/uS)			2000	µSec
Dynamic Load Peak Deviation	same as above			±600	mV
FEATURES and OPTIONS					
Remote On/Off Control ⑥					
“N” suffix:					
Negative Logic, ON state	ON = Ground pin or external voltage	-0.1		0.8	V
Negative Logic, OFF state	OFF = Pin open or external voltage	2.5		15	V
Control Current	Sinking		1	2	mA
“P” suffix:					
Positive Logic, ON state	ON = Pin open or external voltage	3.5		15	V
Positive Logic, OFF state	OFF = Ground pin or external voltage	0		1	V
Control Current	Sinking		1	2	mA
Base Plate	“B” suffix				

FUNCTIONAL SPECIFICATIONS, CONTINUED

OUTPUT						
Total Output Power	See Derating	0.0	234	237.51	W	
Voltage						
Nominal Output Voltage	Vin = 48V, half load, ±1.5 accuracy	11.525	11.7	11.876	Vdc	
Total Output Voltage Range	Over sample load (0-20A) and temperature (see derating curves)	10.5	12	12.5	Vdc	
Vout Overshoot		13		13.4	Vdc	
Overvoltage Protection	Output voltage clamped		13.5		Vdc	
Current						
Output Current Range		0	20	20	A	
Minimum Load			No minimum load			
Current Limit Inception	90% of Vnom., after warmup	24	28	38	A	
Short Circuit						
Short Circuit Current	Hiccup technique, autorecovery within ±1.25% of Vout		4	10	A	
Short Circuit Duration (remove short for recovery)	Output shorted to ground, no damage		Continuous			
Short circuit protection method	Current limiting					
Regulation ⑤						
Line Regulation	Vin = 40 to 75V, Vout = nom., 50% load			±2	%	
Load Regulation	Iout = 0 to 100%, Vin = 48V.			±3	%	
Ripple and Noise	5 Hz- 20 MHz BW		100	150	mV pk-pk	
Temperature Coefficient	At all outputs		±0.02		% of Vnom./°C	
Maximum Capacitive Loading	Cap. ESR, Full resistive load	470		4700	µF	
MECHANICAL (Through Hole Models) Conditions ① ③						
Outline Dimensions (no baseplate)	LxWxH (Please refer to outline drawing)		2.3x0.9x0.4 max.		Inches	
Outline Dimensions (with baseplate)			58.42x22.86x10.16		mm	
				2.3x0.9x0.5		Inches
				58.42x22.86x12.7		mm
Weight (no baseplate)			1.06		Ounces	
			30		Grams	
Weight (with baseplate)			1.46		Ounces	
			41.5		Grams	
Through Hole Pin Diameter	Input pins (see drawings)		0.040±0.001		Inches	
				1.016±0.025		mm
Through Hole Pin Diameter	Output pins (see drawings)		0.062±0.001		Inches	
				1.575±0.025		mm
Through Hole Pin Material			Copper alloy			
TH Pin Plating Metal and Thickness	Nickel subplate		50		µ-inches	
	Gold overplate		5		µ-inches	
Baseplate Material			Aluminum			
ENVIRONMENTAL						
Operating Ambient Temperature Range	With derating, no condensation	-40		85	°C	
Operating Case Temperature	No derating required	-40		120	°C	
Storage Temperature	Vin = Zero (no power)	-55		125	°C	
Thermal Protection/Shutdown		115	125	130	°C	
Electromagnetic Interference Conducted, EN55022/CISPR22	External filter required		B		Class	
Radiated, EN55022/CISPR22	External filter required		B		Class	
RoHS rating ④			RoHS-6			

Notes

- ① Unless otherwise noted, all specifications apply over the full input voltage range, full temperature range, nominal output voltage and full output load. General conditions are near sea level altitude and natural convection airflow unless noted. All models are tested and specified with external parallel 1 µF and 10 µF output capacitors. A 470 µF input capacitor is used across the input pins. All capacitors are low-ESR types mounted close to the converter. These capacitors are necessary for our test equipment and may not be needed in the user's application.
- ② Input (back) ripple current is tested and specified over 5 Hz to 20 MHz bandwidth. Input filtering is Cbus = 220 µF, Cin = 33 µF and Lbus = 12 µH.

- ③ All models are stable and regulate to specification under no load.
- ④ Reduction of Hazardous Substances (RoHS) compliance is to RoHS-6 (six substances restricted including lead).
- ⑤ Regulation specifications describe the output voltage changes as the line voltage or load current is varied from its nominal or midpoint value to either extreme.
- ⑥ The Remote On/Off Control is referred to -Vin.
- ⑦ Please refer to the Part Number Structure for complete ordering model numbers.

TYPICAL PERFORMANCE DATA

Maximum Current Temperature Derating at sea level in Transverse Direction
Vin= 36V (air flow direction is from Vin- to Vin+), no baseplate

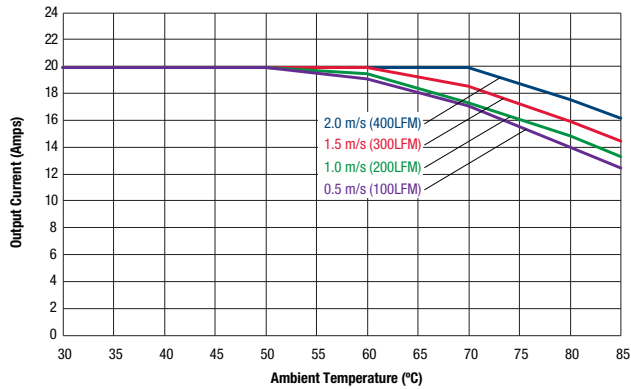

Maximum Current Temperature Derating at sea level in Longitudinal Direction
Vin= 36V (air flow direction is from Vin to Vout), no baseplate

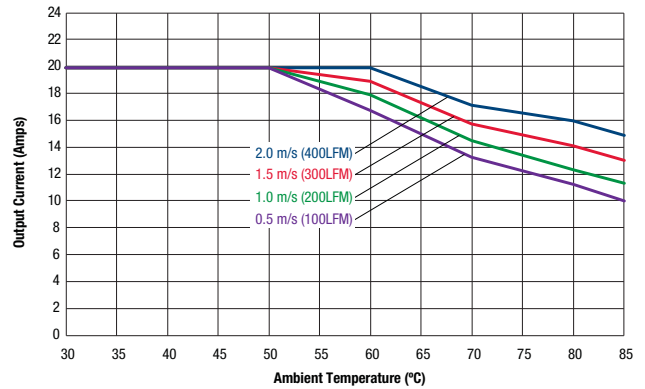

Maximum Current Temperature Derating at sea level in Transverse Direction
Vin= 48V (air flow direction is from Vin- to Vin+), no baseplate

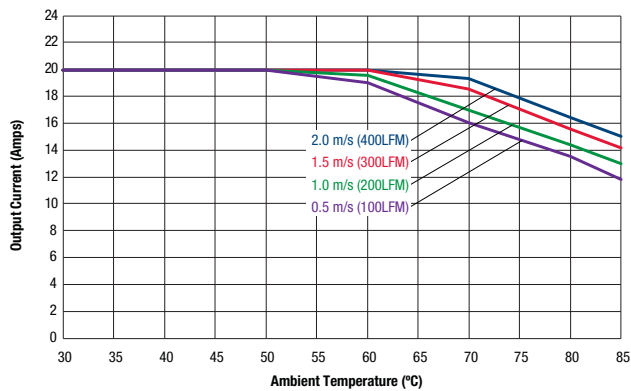

Maximum Current Temperature Derating at sea level in Longitudinal Direction
Vin= 48V (air flow direction is from Vin to Vout), no baseplate

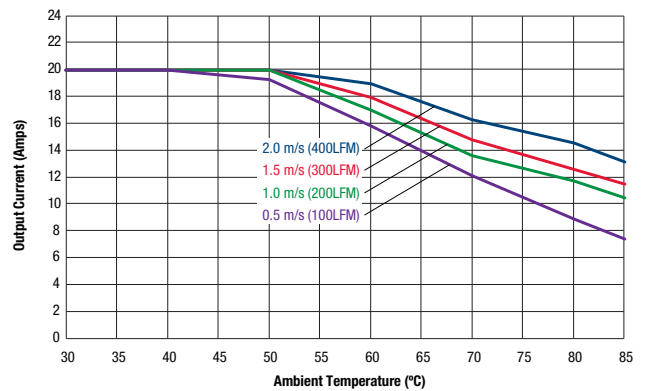

Maximum Current Temperature Derating at sea level in Transverse Direction
Vin= 75V (air flow direction is from Vin- to Vin+), no baseplate

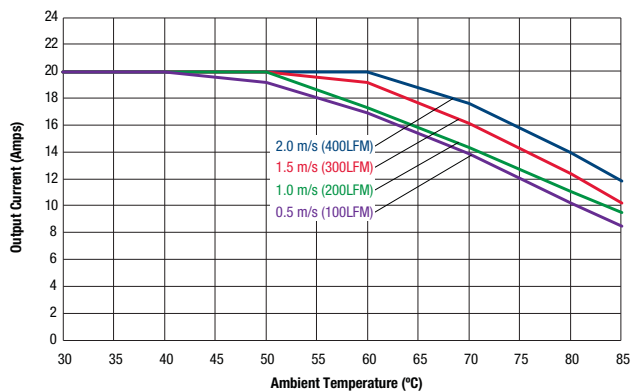

Maximum Current Temperature Derating at sea level in Longitudinal Direction
Vin= 75V (air flow direction is from Vin to Vout), no baseplate

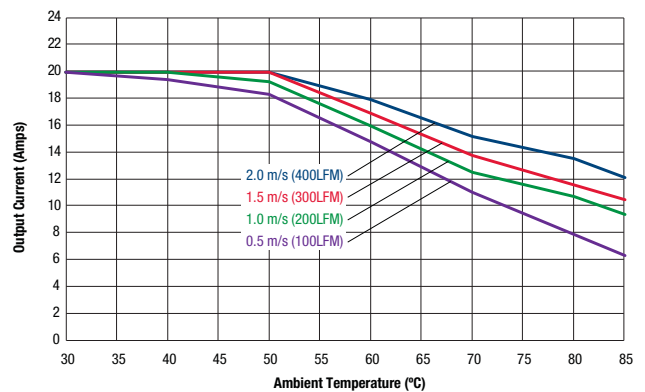

TYPICAL PERFORMANCE DATA

Maximum Current Temperature Derating at sea level in Transverse Direction
Vin= 36V (air flow direction is from Vin- to Vin+), with baseplate

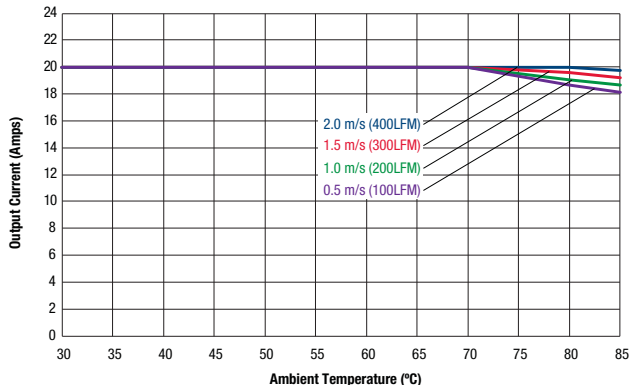

Maximum Current Temperature Derating at sea level in Longitudinal Direction
Vin= 36V (air flow direction is from Vin to Vout), with baseplate

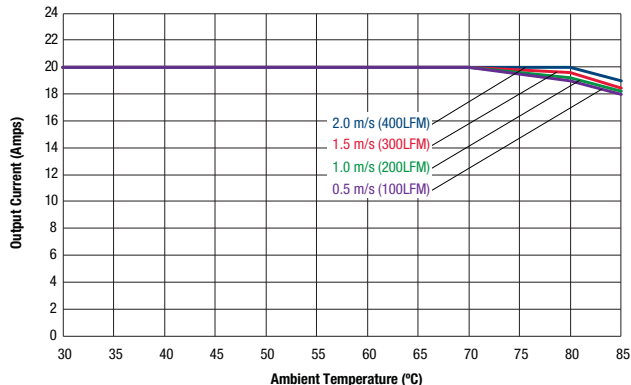

Maximum Current Temperature Derating at sea level in Transverse Direction
Vin= 48V (air flow direction is from Vin- to Vin+), with baseplate

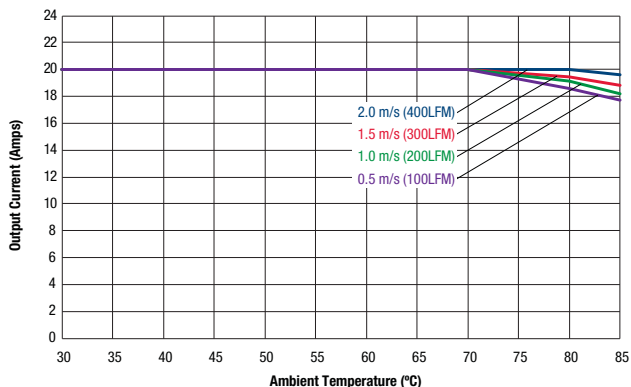

Maximum Current Temperature Derating at sea level in Longitudinal Direction
Vin= 48V (air flow direction is from Vin to Vout), with baseplate

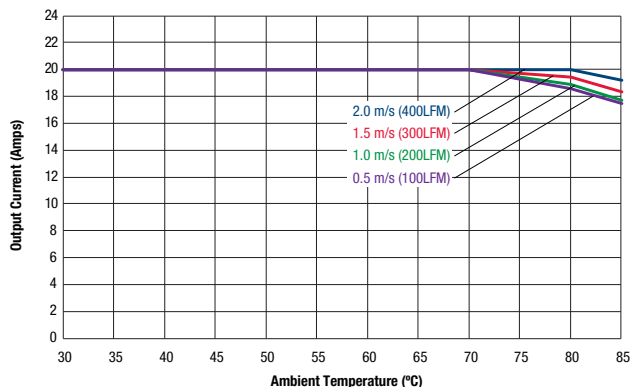

Maximum Current Temperature Derating at sea level in Transverse Direction
Vin= 75V (air flow direction is from Vin- to Vin+), with baseplate

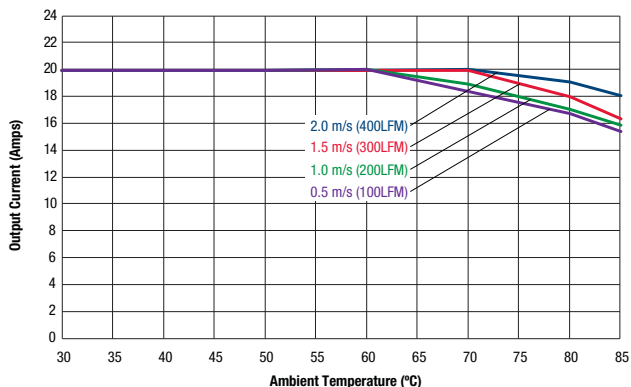

Maximum Current Temperature Derating at sea level in Longitudinal Direction
Vin= 75V (air flow direction is from Vin to Vout), with baseplate

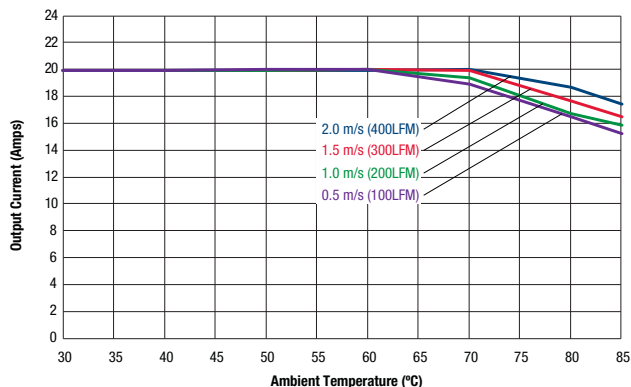

TYPICAL PERFORMANCE DATA

On/Off Enable start up (Vin=48V, Iout=20A, Load=470uF, Ta=+25°C)
Ch2=Vout, Ch4=Enable

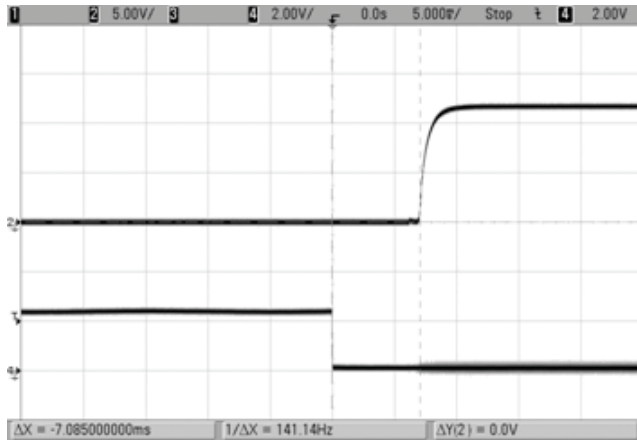

On/Off Enable start up (Vin=48V, Iout=0A, Load=470uF, Ta=+25°C)
Ch2=Vout, Ch4=Enable

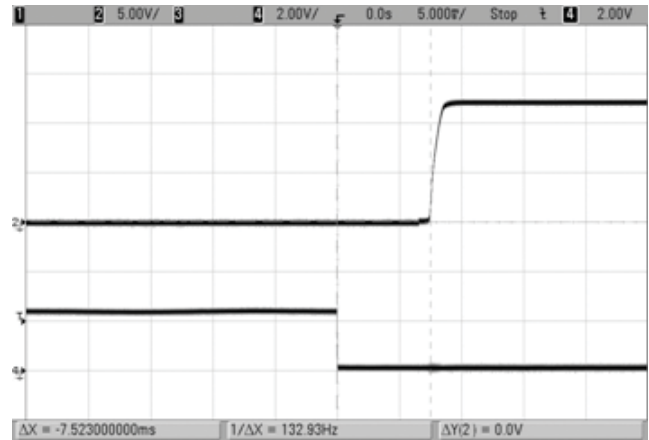

On/Off Enable start up (Vin=48V, Iout=20A, Load=4700uF, Ta=+25°C)
Ch2=Vout, Ch4=Enable

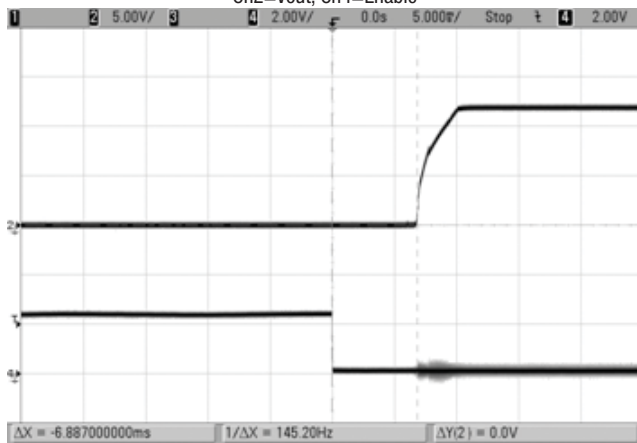

Start up Delay (Vin=48V, Iout=20A, Load=470uF, Ta=+25°C) Ch1=Vin, Ch2=Vout

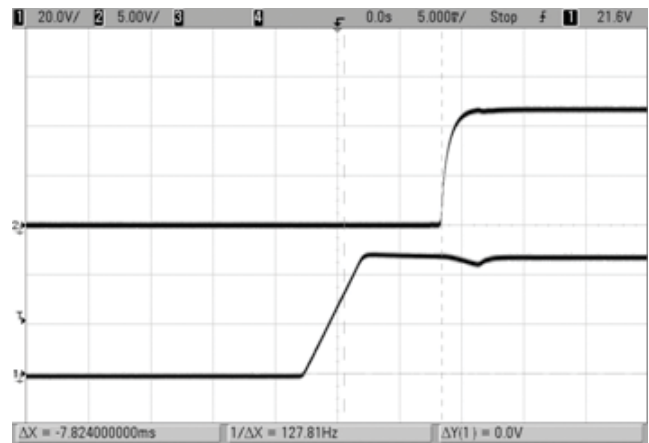

Start up Delay (Vin=48V, Iout=0A, Load=470uF, Ta=+25°C) Ch1=Vin, Ch2=Vout

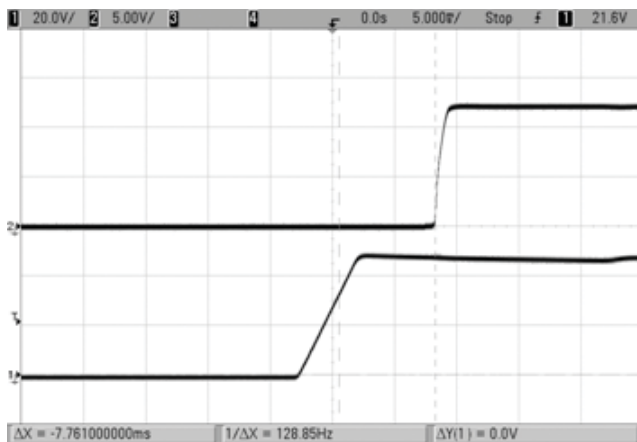

Start up Delay (Vin=48V, Iout=20A, Load=4700uF, Ta=+25°C) Ch1=Vin, Ch2=Vout

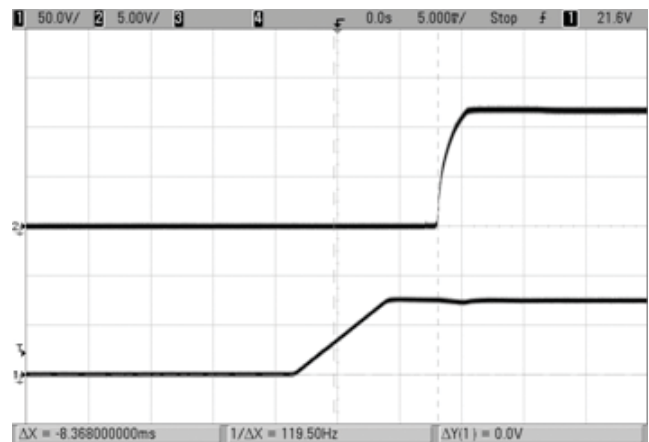

TYPICAL PERFORMANCE DATA

Efficiency vs. Line Voltage and Load Current @ 25°C

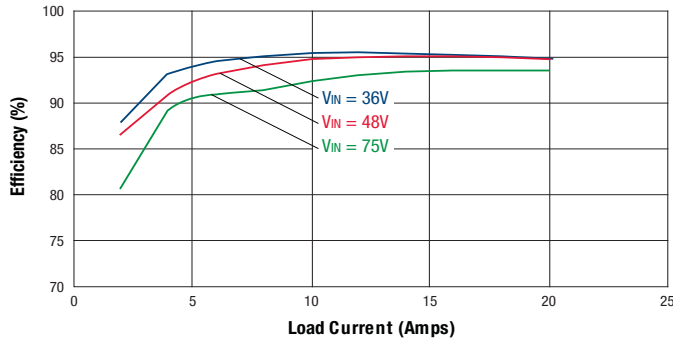

Thermal image with hot spot at full load current with 30°C ambient; air is flowing at 100 LFM. Air is flowing across the converter from -Vin to +Vin at 48V input. Identifiable and recommended maximum value to be verified in application.

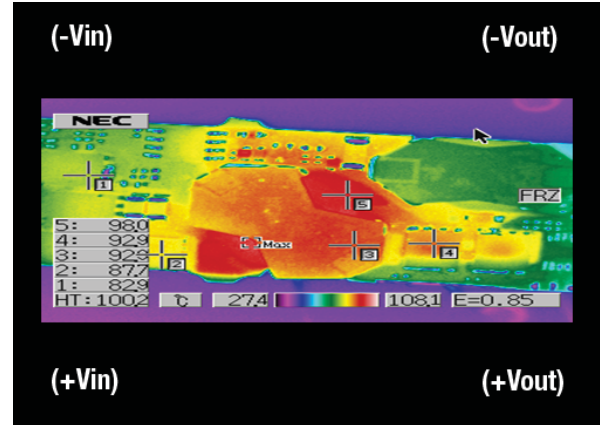

Typical Output Voltage (Vout) vs. Input Voltage (Vin) at +25°C

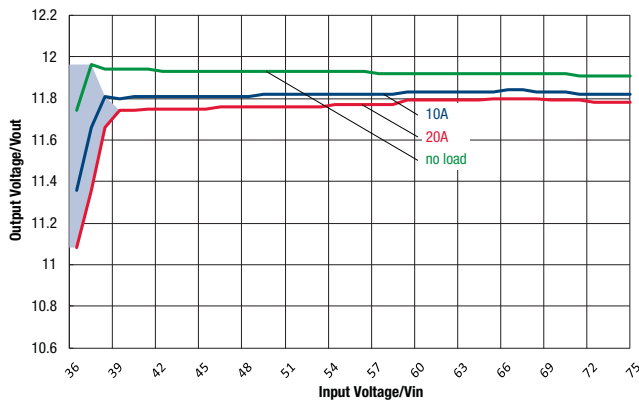

The RBE-12/20-D48 is not designed to be operated within the shaded area. The output voltage will be fully regulated within the white area in the graph above. Operation outside of this area is not recommended for normal use.

Typical Output Voltage (Vout) vs. Output load at +25°C

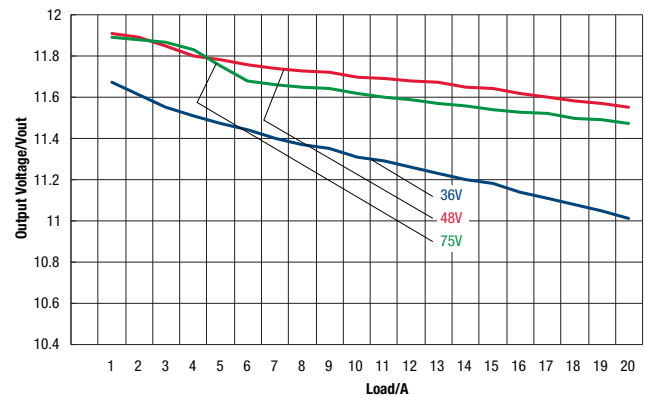

TYPICAL PERFORMANCE DATA

Typical Startup Waveform with a 4V bias voltage

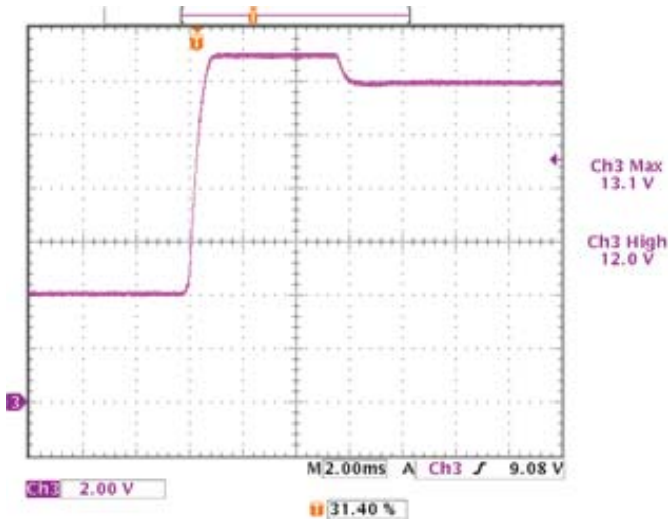

Typical Startup Waveform with a 8V bias voltage

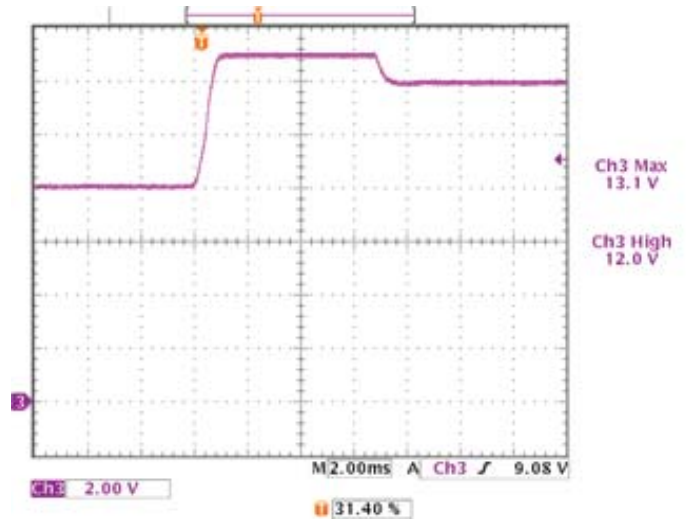

Output Ripple and Noise ($V_{in} = 48V$, $I_{out} = 20A$, $C_{load} = 1\mu F \parallel 10\mu F$, $T_a = +25^\circ C$)

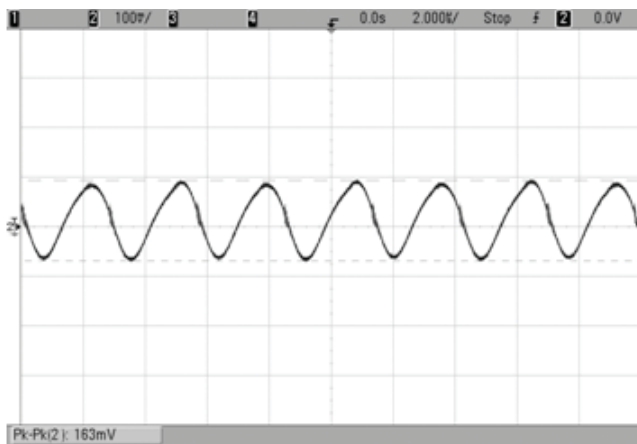

Output Ripple and Noise ($V_{in} = 48V$, $I_{out} = 0A$, $C_{load} = 1\mu F \parallel 10\mu F$, $T_a = +25^\circ C$)

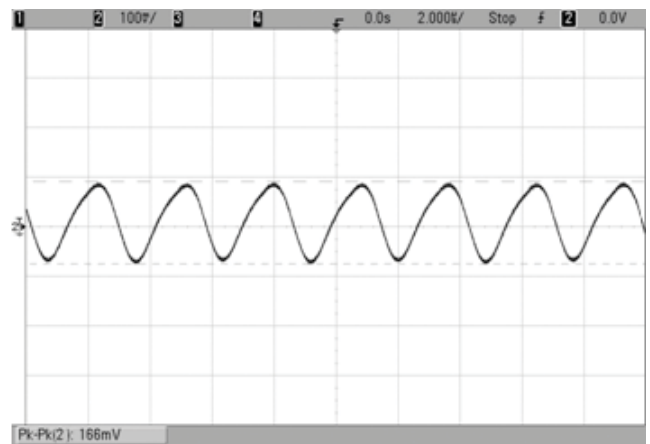

Output Ripple and Noise ($V_{in} = 48V$, $I_{out} = 20A$, $C_{load} = 4700\mu F$, $T_a = +25^\circ C$)

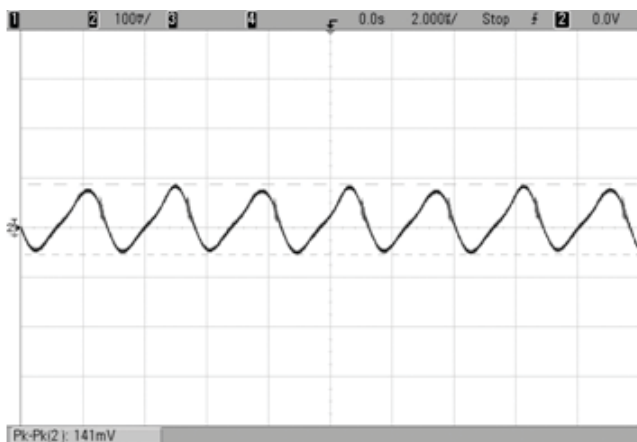

Stepload Transient Response ($V_{in} = 48V$, $C_{load} = 470\mu F$, $I_{out} = 50\text{-}75\text{-}50\%$ of I_{max} , $1A/\mu S$, $T_a = +25^\circ C$)

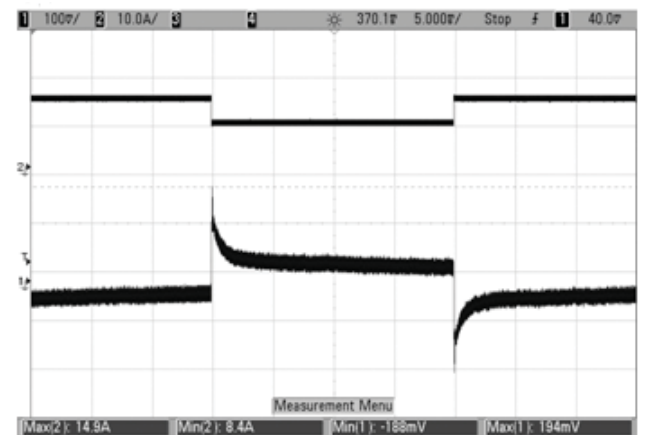

MECHANICAL SPECIFICATIONS (THROUGH-HOLE MOUNT)

WITH BASEPLATE OPTION

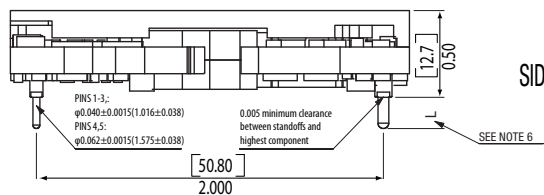

SIDE VIEW

OPEN FRAME

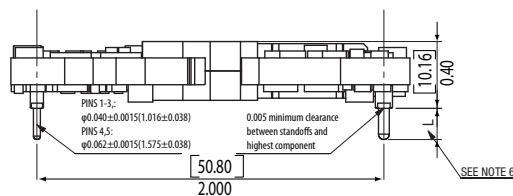

SEE NOTE 6

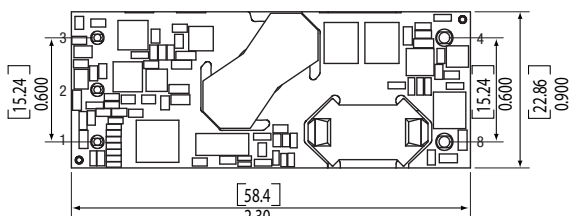

BOTTOM PIN SIDE VIEW

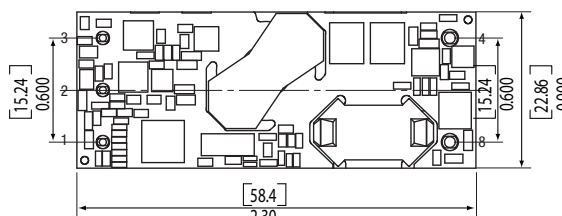

BOTTOM PIN SIDE VIEW

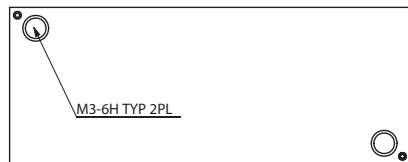

TOP VIEW

RECOMMENDED FOOTPRINT (VIEW THROUGH CONVERTER)

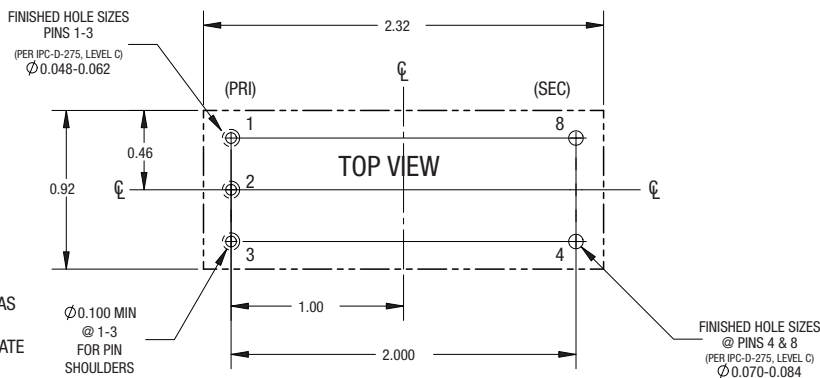

IT IS RECOMMENDED THAT NO PARTS BE PLACED BENEATH CONVERTER

- NOTES:
 UNLESS OTHERWISE SPECIFIED;
 1: M3 SCREW USED TO BOLT UNIT'S BASEPLATE TO OTHER SURFACES (SUCH AS HEATSINK) MUST NOT EXCEED 0.120" (3.0mm) DEPTH BELOW THE SURFACE OF BASEPLATE
 2: APPLIED TORQUE PER SCREW SHOULD NOT EXCEED 5.3In-lb (0.6Nm);
 3: ALL DIMENSIONS ARE IN INCHES (MILLIMETER);
 4: ALL TOLERANCES: $x.xx \times in \pm 0.02in (x.xxmm, \pm 0.5mm)$
 $x.xx \times in \pm 0.01in (x.xxmm, \pm 0.25mm)$
 5: COMPONENT WILL VARY BETWEEN MODELS
 6: STANDARD PIN LENGTH: 0.180 Inch
 7: FINISH: (ALL PINS) GOLD (5u" MIN) OVER NICKEL (50u" MIN)
 FOR L2 PIN LENGTH OPTION IN MODEL NAME., USE STANDARD L2 PIN WITH PIN LENGTH TO 0.145 Inch

Dimensions are in inches (mm shown for ref. only).

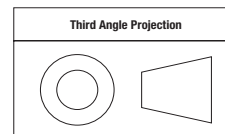

Tolerances (unless otherwise specified):
 .XX $\pm 0.02 (0.5)$
 .XXX $\pm 0.010 (0.25)$
 Angles $\pm 2^\circ$

Components are shown for reference only and may vary between units.

INPUT/OUTPUT CONNECTIONS

Pin		Pin	
1	+Vin	4	-Vout
2	Remote On/Off	8	+Vout
3	-Vin		

MECHANICAL SPECIFICATIONS (SURFACE MOUNT, MSL RATING 1)

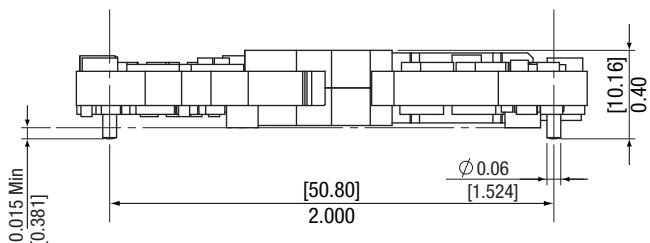

NOTES:
 UNLESS OTHERWISE SPECIFIED;
 1: ALL DIMENSIONS ARE IN INCHES [MILLIMETER];
 2: ALL TOLERANCES: $x.xx \times in, \pm 0.02 in (x.x \text{ mm}, \pm 0.5 \text{ mm})$
 $x.x \times in, \pm 0.01 in (x.x \text{ mm}, \pm 0.25 \text{ mm})$
 3: COMPONENT WILL VARY BETWEEN MODELS

Dimensions are in inches (mm shown for ref. only).

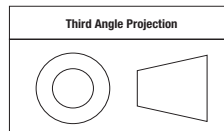

Tolerances (unless otherwise specified):
 .XX ± 0.02 (0.5)
 .XXX ± 0.010 (0.25)
 Angles $\pm 2^\circ$

Components are shown for reference only and may vary between units.

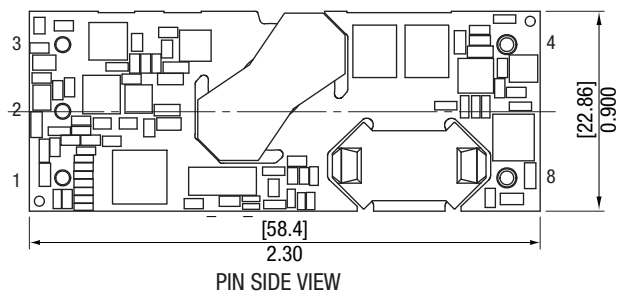

INPUT/OUTPUT CONNECTIONS			
Pin		Pin	
1	+Vin	4	-Vout
2	Remote On/Off	8	+Vout
3	-Vin		

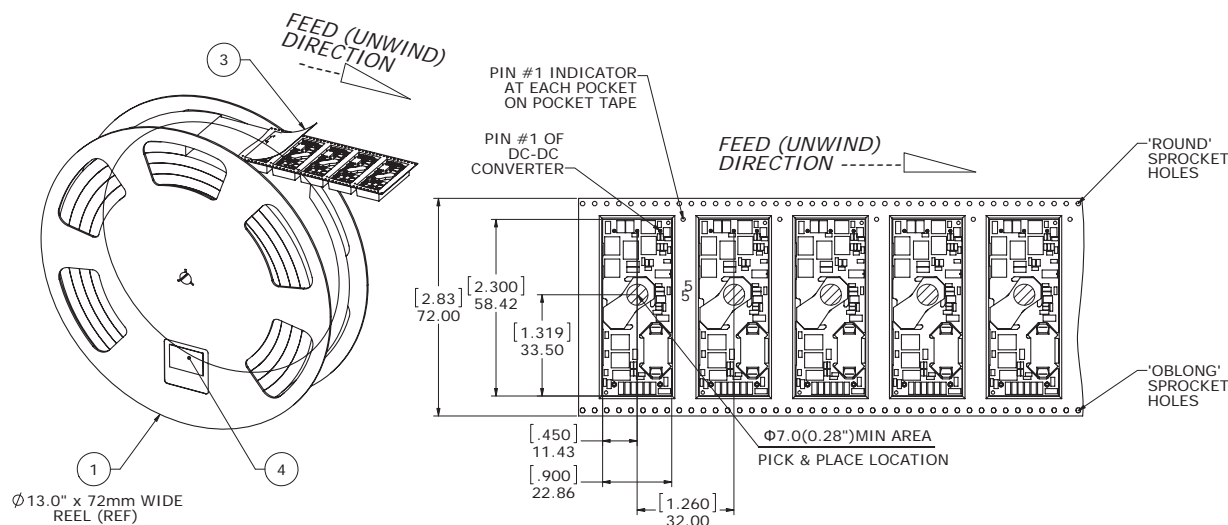

NOTES: (UNLESS OTHERWISE SPECIFIED)

- REFER TO SPECIFIC BOM FOR LIST OF PARTS
- NOTE ORIENTATION OF PARTS IN POCKETS
- APPLY MARKING LABEL (ITEM 4) AS SHOWN
- LEAVE THE FIRST SEVEN (7) POCKETS EMPTY, FILL THE NEXT 100 POCKETS WITH PRODUCT, AND LEAVE EIGHT (8) POCKETS MINIMUM EMPTY ON THE END OF THE REEL.
- PEEL FORCE OF THE COVER TAPE:
 THE ANGLE BETWEEN THE COVER TAPE DURING PEEL-OFF AND THE UNREELING DIRECTION SHALL BE 180° FOR A PEEL SPEED OF 39IN/MIN. THE PEEL FORCE SHALL BE 30-60 GRAMS, SEE MURATA-PS PROCEDURE A-46002. THE COVER TAPE SHALL ADHERE UNIFORMLY TO THE CARRIER (POCKET) TAPE.

TECHNICAL NOTES

Thermal Shutdown

Extended operation at excessive temperature will initiate overtemperature shutdown triggered by a temperature sensor inside the PWM controller. This operates similarly to overcurrent and short circuit mode. The inception point of the overtemperature condition depends on the average power delivered, the ambient temperature and the extent of forced cooling airflow. Thermal shutdown uses only the hiccup mode (autorestart).

Start Up Considerations

When power is first applied to the DC/DC converter, there is some risk of start up difficulties if you do not have both low AC and DC impedance and adequate regulation of the input source. Make sure that your source supply does not allow the instantaneous input voltage to go below the minimum voltage at all times.

Use a moderate size capacitor very close to the input terminals. You may need two or more parallel capacitors. A larger electrolytic or ceramic cap supplies the surge current and a smaller parallel low-ESR ceramic cap gives low AC impedance.

Remember that the input current is carried both by the wiring and the ground plane return. Make sure the ground plane uses adequate thickness copper. Run additional bus wire if necessary.

Input Fusing

Certain applications and/or safety agencies may require fuses at the inputs of power conversion components. Fuses should also be used when there is the possibility of sustained input voltage reversal which is not current-limited. For greatest safety, we recommend a fast blow fuse installed in the ungrounded input supply line.

Input Under-Voltage Shutdown and Start-Up Threshold

Under normal start-up conditions, converters will not begin to regulate properly until the rising input voltage exceeds and remains at the Start-Up Threshold Voltage (see Specifications). Once operating, converters will not turn off until the input voltage drops below the Under-Voltage Shutdown Limit. Subsequent restart will not occur until the input voltage rises again above the Start-Up Threshold. This built-in hysteresis prevents any unstable on/off operation at a single input voltage.

Start-Up Time

Assuming that the output current is set at the rated maximum, the Vin to Vout Start-Up Time (see Specifications) is the time interval between the point when the rising input voltage crosses the Start-Up Threshold and the fully loaded output voltage enters and remains within its specified accuracy band. Actual measured times will vary with input source impedance, external input capacitance, input voltage slew rate and final value of the input voltage as it appears at the converter.

These converters include a soft start circuit to moderate the duty cycle of its PWM controller at power up, thereby limiting the input inrush current.

The On/Off Remote Control interval from On command to Vout (final $\pm 5\%$) assumes that the converter already has its input voltage stabilized above the Start-Up Threshold before the On command. The interval is measured from the On command until the output enters and remains within its specified accuracy

band. The specification assumes that the output is fully loaded at maximum rated current. Similar conditions apply to the On to Vout regulated specification such as external load capacitance and soft start circuitry.

Recommended Input Filtering

The user must assure that the input source has low AC impedance to provide dynamic stability and that the input supply has little or no inductive content, including long distributed wiring to a remote power supply. The converter will operate with no additional external capacitance if these conditions are met.

For best performance, we recommend installing a low-ESR capacitor immediately adjacent to the converter's input terminals. The capacitor should be a ceramic type such as the Murata GRM32 series or a polymer type. Make sure that the input terminals do not go below the undervoltage shutdown voltage at all times. More input bulk capacitance may be added in parallel if needed.

Recommended Output Filtering

The converter will achieve its rated output ripple and noise with no additional external capacitor. However, the user may install more external output capacitance to reduce the ripple even further or for improved dynamic response. Again, use low-ESR ceramic (Murata GRM32 series) or polymer capacitors. Mount these close to the converter. Measure the output ripple under your load conditions.

Use only as much capacitance as required to achieve your ripple and noise objectives. Excessive capacitance can make step load recovery sluggish or possibly introduce instability. Do not exceed the maximum rated output capacitance listed in the specifications.

Input Ripple Current and Output Noise

All models in this converter series are tested and specified for input reflected ripple current and output noise using designated external input/output components, circuits and layout as shown in the figures below. The Cbus and Lbus components simulate a typical DC voltage bus.

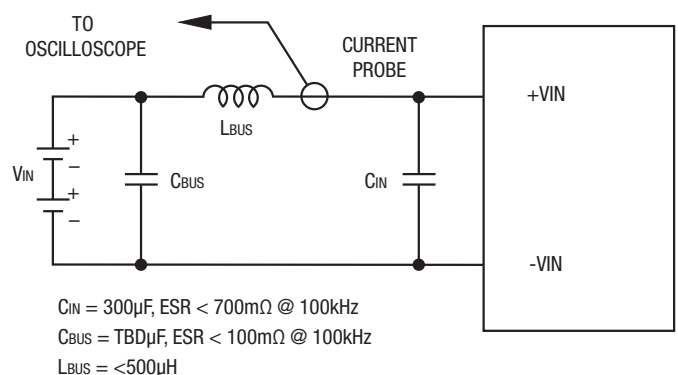

Figure 2. Measuring Input Ripple Current

Minimum Output Loading Requirements

All models regulate within specification and are stable under no load to full load conditions. Operation under no load might however slightly increase output ripple and noise.

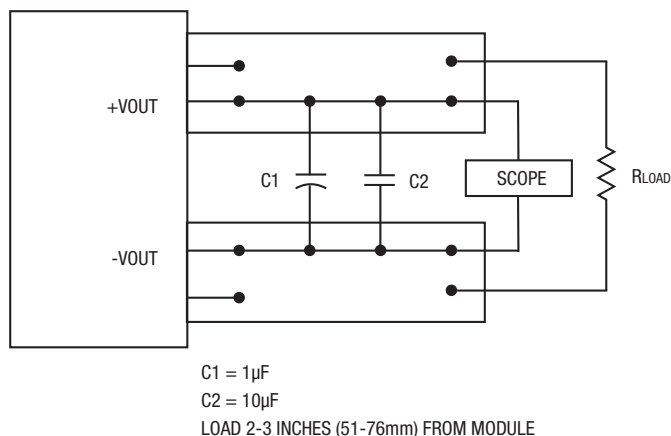

Figure 3. Measuring Output Ripple and Noise (PARD)

Thermal Shutdown

To prevent many over temperature problems and damage, these converters include thermal shutdown circuitry. If environmental conditions cause the temperature of the DC/DC's to rise above the Operating Temperature Range up to the shutdown temperature, an on-board electronic temperature sensor will power down the unit. When the temperature decreases below the turn-on threshold, the converter will automatically restart. There is a small amount of hysteresis to prevent rapid on/off cycling.

CAUTION: If you operate too close to the thermal limits, the converter may shut down suddenly without warning. Be sure to thoroughly test your application to avoid unplanned thermal shutdown.

Temperature Derating Curves

The graphs in this data sheet illustrate typical operation under a variety of conditions. The Derating curves show the maximum continuous ambient air temperature and decreasing maximum output current which is acceptable under increasing forced airflow measured in Linear Feet per Minute ("LFM"). Note that these are AVERAGE measurements. The converter will accept brief increases in current or reduced airflow as long as the average is not exceeded.

Note that the temperatures are of the ambient airflow, not the converter itself which is obviously running at higher temperature than the outside air. Also note that "natural convection" is defined as very low flow rates which are not using fan-forced airflow. Depending on the application, "natural convection" is usually about 30-65 LFM but is not equal to still air (0 LFM).

Murata Power Solutions makes Characterization measurements in a closed cycle wind tunnel with calibrated airflow. We use both thermocouples and an infrared camera system to observe thermal performance. As a practical matter, it is quite difficult to insert an anemometer to precisely measure airflow in most applications. Sometimes it is possible to estimate the effective airflow if you thoroughly understand the enclosure geometry, entry/exit orifice areas and the fan flowrate specifications.

CAUTION: If you exceed these Derating guidelines, the converter may have an unplanned Over Temperature shut down. Also, these graphs are all collected near Sea Level altitude. Be sure to reduce the derating for higher altitude.

Output Fusing

The converter is extensively protected against current, voltage and temperature extremes. However your output application circuit may need additional protection. In the extremely unlikely event of output circuit failure, excessive voltage could be applied to your circuit. Consider using an appropriate fuse in series with the output.

Output Current Limiting

Current limiting inception is defined as the point at which full power falls below the rated tolerance. See the Performance/Functional Specifications. Note particularly that the output current may briefly rise above its rated value in normal operation as long as the average output power is not exceeded. This enhances reliability and continued operation of your application. If the output current is too high, the converter will enter the short circuit condition.

Output Short Circuit Condition

When a converter is in current-limit mode, the output voltage will drop as the output current demand increases. If the output voltage drops too low (approximately 97% of nominal output voltage for most models), the PWM controller will shut down. Following a time-out period, the PWM will restart, causing the output voltage to begin rising to its appropriate value. If the short-circuit condition persists, another shutdown cycle will initiate. This rapid on/off cycling is called "hiccup mode." The hiccup cycling reduces the average output current, thereby preventing excessive internal temperatures and/or component damage. A short circuit can be tolerated indefinitely.

The "hiccup" system differs from older latching short circuit systems because you do not have to power down the converter to make it restart. The system will automatically restore operation as soon as the short circuit condition is removed.

Remote On/Off Control

On the input side, a remote On/Off Control can be specified with either logic type. Please refer to the Connection Diagram on page 1 for On/Off connections.

Positive-logic models are enabled when the On/Off pin is left open or is pulled high to +15V with respect to -VIN. Positive-logic devices are disabled when the On/Off is grounded or brought to within a low voltage (see Specifications) with respect to -VIN.

Negative-Models with negative logic are on (enabled) when the On/Off is grounded or brought to within a low voltage (see Specifications) with respect to -VIN. The device is off (disabled) when the On/Off is left open or is pulled high to +15VDC Max. with respect to -VIN.

Dynamic control of the On/Off function should be able to sink the specified signal current when brought low and withstand the specified voltage when brought high. Be aware too that there is a finite time in milliseconds (see Specifications) between the time of On/Off Control activation and stable, output. This time will vary slightly with output load type and current and input conditions.

Output Capacitive Load

These converters do not require external capacitance added to achieve rated specifications. Users should only consider adding capacitance to reduce switching noise and/or to handle spike current load steps. Install only enough capacitance to achieve noise objectives. Excess external capacitance may cause degraded transient response and possible oscillation or instability.

Output OVP (Output Clamped)

The RBE-12/20-D48 module incorporates circuitry to protect the output/load (Output OVP, Over Voltage Protection) by effectively clamping the output voltage to a maximum of 13.5V under certain fault conditions. The initial output voltage is set at the factory for an accuracy of $\pm 1.5\%$, and is regulated over line load and temperature using a closed loop feedback system. In the event of a failure that causes the module to operate open loop (failure in the control loop), the output voltage will be determined by the input voltage/duty cycle of the voltage conversion (Pulse Width Modulation) circuit. For example, when the input voltage is at 36V, the duty cycle is D1; when the input voltage is at 75V, the maximum duty cycle is D1/2; this change in duty cycle compensates Vout for Vin changes. As Vin continues to increase above 75V the voltage at Vout is clamped because maximum duty cycle has been reached. The output voltage is always proportional to $V_{in} \cdot \text{Duty}$ in a buck derived topology. Figure 4 is the test waveform for the RBE-12/20-D48 module when its feedback loop is open, simulating a loop failure. Channel 1 is the input voltage and Channel 2 is the output voltage. When the input voltage climbs from 48Vdc to 100Vdc, the output voltage remains stable.



Figure 4. Test Waveform with Feedback Loop Open

Through-Hole Soldering Guidelines

Murata Power Solutions recommends the specifications below when installing these converters. These specifications vary depending on the solder type. Exceeding these specifications may cause damage to the product. Your production environment may differ; therefore please thoroughly review these guidelines with your process engineers.

Wave Solder Operations for through-hole mounted products (THMT)

For Sn/Ag/Cu based solders:

Maximum Preheat Temperature	115°C.
Maximum Pot Temperature	270°C.
Maximum Solder Dwell Time	7 seconds

For Sn/Pb based solders:

Maximum Preheat Temperature	105°C.
Maximum Pot Temperature	250°C.
Maximum Solder Dwell Time	6 seconds

SMT Reflow Soldering Guidelines

The surface-mount reflow solder profile shown below is suitable for SAC305 type lead-free solders. This graph should be used only as a **guideline**. Many other factors influence the success of SMT reflow soldering. Since your production environment may differ, please thoroughly review these guidelines with your process engineers.

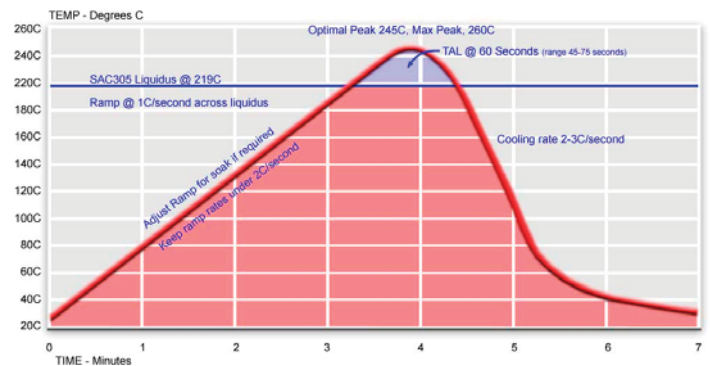

Emissions Performance

Murata Power Solutions measures its products for radio frequency emissions against the EN 55022 and CISPR 22 standards. Passive resistance loads are employed and the output is set to the maximum voltage. If you set up your own emissions testing, make sure the output load is rated at continuous power while doing the tests.

The recommended external input and output capacitors (if required) are included. Please refer to the fundamental switching frequency. All of this information is listed in the Product Specifications. An external discrete filter is installed and the circuit diagram is shown below.

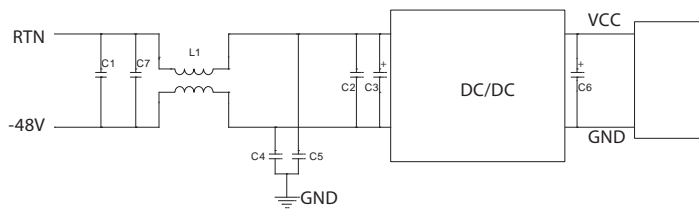

Figure 5. Conducted Emissions Test Circuit

[1] Conducted Emissions Parts List

Item	Reference	Description
1	C1, C7	SMD -100V-1000nF-X7R-1210
2	C2	SMD -100V-100nF-±10%-X7R-1206
3	L1	-809uH-±25%-9.7A-R5K-28*26*12.7mm
4	C4, C5	0.1U/250V, 13*12*6-0.6-10mm
5	C6	4700 µF
6	C3	220 µF

[2] Conducted Emissions Test Equipment Used

- Hewlett Packard HP8594L Spectrum Analyzer – S/N 3827A00153
- 2Line V-networks LS1-15V 50Ω /50Uh Line Impedance Stabilization Network

[3] Conducted Emissions Test Results

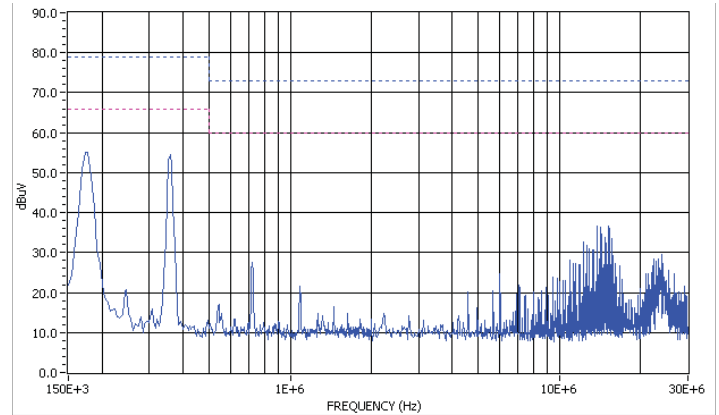

Peak Detection Value

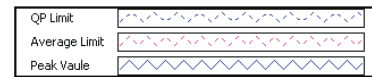

Graph 1. Conducted emissions performance, Positive Line, CISPR 22, Class A, full load

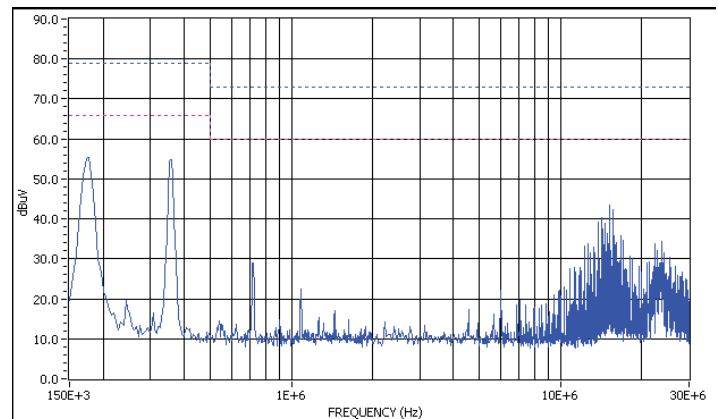

Peak Detection Value

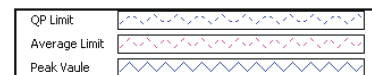

Graph 2. Conducted emissions performance, Negative Line, CISPR 22, Class A, full load

[4] Layout Recommendations

Most applications can use the filtering which is already installed inside the converter or with the addition of the recommended external capacitors. For greater emissions suppression, consider additional filter components and/or shielding. Emissions performance will depend on the user's PC board layout, the chassis shielding environment and choice of external components. Please refer to Application Note GEAN02 for further discussion.

Since many factors affect both the amplitude and spectra of emissions, we recommend using an engineer who is experienced at emissions suppression.

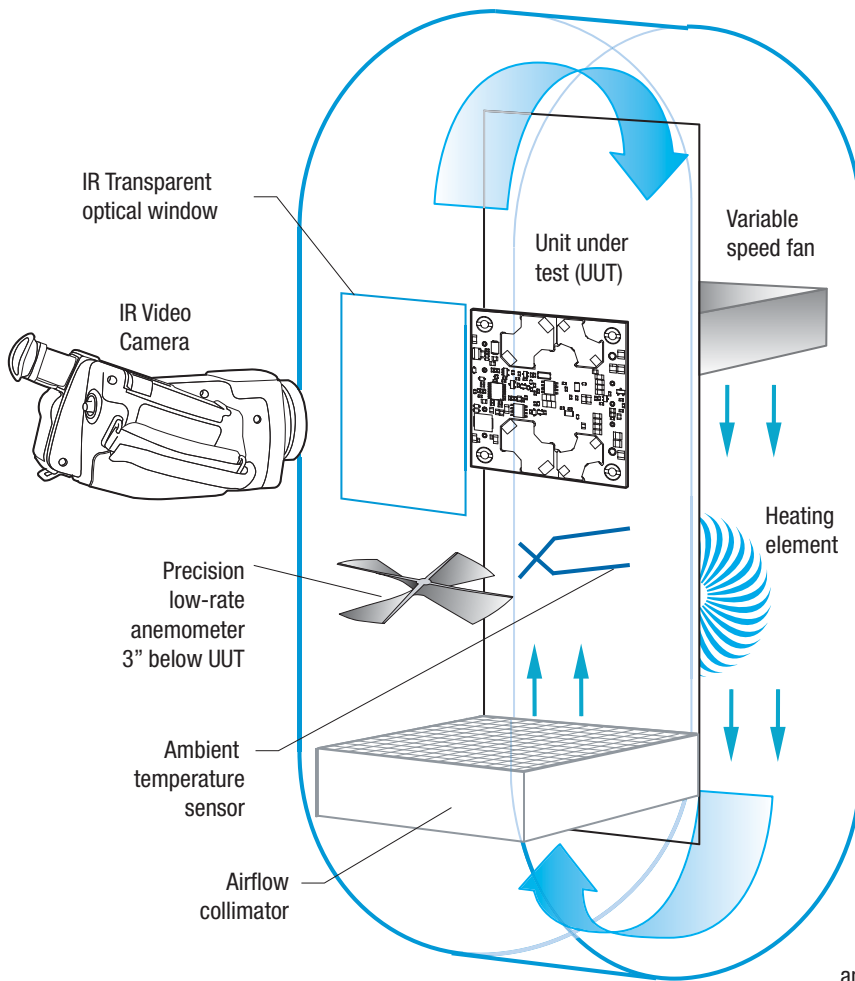

Figure 6. Vertical Wind Tunnel

Vertical Wind Tunnel

Murata Power Solutions employs a computer controlled custom-designed closed loop vertical wind tunnel, infrared video camera system, and test instrumentation for accurate airflow and heat dissipation analysis of power products. The system includes a precision low flow-rate anemometer, variable speed fan, power supply input and load controls, temperature gauges, and adjustable heating element.

The IR camera monitors the thermal performance of the Unit Under Test (UUT) under static steady-state conditions. A special optical port is used which is transparent to infrared wavelengths.

Both through-hole and surface mount converters are soldered down to a 10"x 10" host carrier board for realistic heat absorption and spreading. Both longitudinal and transverse airflow studies are possible by rotation of this carrier board since there are often significant differences in the heat dissipation in the two airflow directions. The combination of adjustable airflow, adjustable ambient heat, and adjustable Input/Output currents and voltages mean that a very wide range of measurement conditions can be studied.

The collimator reduces the amount of turbulence adjacent to the UUT by minimizing airflow turbulence. Such turbulence influences the effective heat transfer characteristics and gives false readings. Excess turbulence removes more heat from some surfaces and less heat from others, possibly causing uneven overheating.

Both sides of the UUT are studied since there are different thermal gradients on each side. The adjustable heating element and fan, built-in temperature gauges, and no-contact IR camera mean that power supplies are tested in real-world conditions.

