

PLASTIC FILM CAPACITORS

QXK

Metallized Polyester Film Capacitor

(Extended Standard Type)



Smaller

- Highly reliable and superior performance in high frequency applications, self-healing and non-inductive construction, using a dielectric made of polyethylene terephthalate film covered with vacuum-evaporated metal.
- Large capacitance in small dimensions.
- Finished by inner dipping with liquid epoxy resin and outer coating with flame-retardant epoxy resin, those double coating provides excellent humidity resistance.
- Designed 1mm max. of epoxy on lead wire for best performance at soldering process on P.C. board assemblies.
- Compliant to the RoHS directive (2011/65/EU).

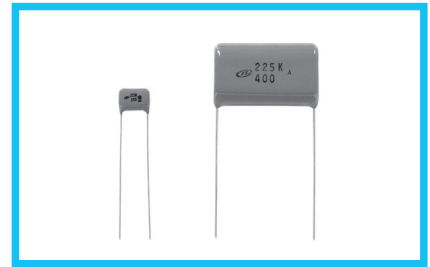

Applications

- General electronic and communications equipment. Contact us for details for use in AC circuits.
- However, do not use this product for across-the-line applications.

Specifications

Item	Performance Characteristics
Category Temperature Range	-40 to +105°C (Rated temperature : 85°C)
Rated Voltage (U _R)	250, 400, 630VDC
Rated Capacitance Range	0.01 to 10μF
Capacitance Tolerance	±5% (J)※, ±10% (K)
Dielectric Loss Tangent	0.8% or less (at 1kHz 20°C)
Insulation Resistance	C ≤ 0.33μF : 9000 MΩ or more C > 0.33μF : 3000 ΩF or more
Withstand Voltage	Between Terminals : Rated Voltage × 175%, 1 to 5 secs. Between Terminals and Coverage : Rated Voltage × 200%, 1 to 5 secs.
Encapsulation	Flame retardant epoxy resin

※ Except for 250VDC 0.01 to 0.15μF
400VDC 0.01 to 0.033μF

Category voltage = U_R × 0.7

Type numbering system (Example : 630V 0.01μF)

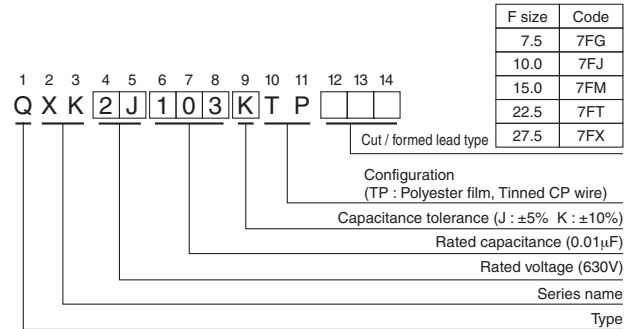

AC Voltage

- AC Voltage (Operating at 50 / 60Hz AC circuit) shall be as follows. However, do not use this product for across-the-line applications.

DC Rated Voltage	250VDC	400VDC	630VDC
AC Voltage	125VAC	200VAC	250VAC

※ When operating capacitors in the high frequency circuit, maximum permissible value (VAC) can be calculated from table 2, provided that the effective current (I_e) and the effective VA (V_e × V_e) shall not exceed the values specified in table 4. Shown in Pages 384, 387.

Drawing

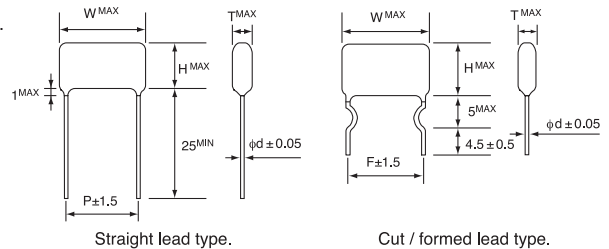

Dimensions

Cap.(μF)	V(Code) Size	250VDC (2E)						400VDC (2G)						630VDC (2J)					
		T	W	H	d	P	F	T	W	H	d	P	F	T	W	H	d	P	F
0.01	103	4.4	11.0	8.1	0.6	7.5	7.5	4.4	11.0	8.1	0.6	7.5	7.5	4.4	13.5	9.5	0.6	10.0	10.0
0.015	153	5.0	11.0	8.7	0.6	7.5	7.5	5.0	11.0	8.7	0.6	7.5	7.5	4.7	13.5	9.8	0.6	10.0	10.0
0.022	223	4.4	11.0	8.5	0.6	7.5	7.5	4.3	11.0	8.4	0.6	7.5	7.5	5.1	13.5	10.8	0.6	10.0	10.0
0.033	333	4.4	11.0	8.5	0.6	7.5	7.5	4.9	11.0	9.1	0.6	7.5	7.5	5.9	13.5	11.6	0.6	10.0	10.0
0.047	473	4.0	11.0	8.1	0.6	7.5	7.5	4.7	13.5	9.8	0.6	10.0	10.0	6.4	13.5	13.7	0.6	10.0	10.0
0.068	683	4.7	11.0	8.7	0.6	7.5	7.5	5.4	13.5	10.5	0.6	10.0	10.0	5.8	18.5	11.5	0.6	15.0	15.0
0.1	104	5.2	11.0	9.4	0.6	7.5	7.5	6.1	13.5	11.7	0.6	10.0	10.0	6.4	18.5	13.7	0.6	15.0	15.0
0.15	154	6.1	11.0	10.3	0.6	7.5	7.5	5.1	18.5	12.4	0.6	15.0	15.0	7.1	18.5	15.9	0.6	15.0	15.0
0.22	224	5.9	13.5	11.0	0.6	10.0	10.0	5.9	18.5	13.2	0.6	15.0	15.0	9.6	18.5	15.3	0.6	15.0	15.0
0.33	334	6.7	13.5	12.4	0.6	10.0	10.0	7.6	18.5	13.3	0.6	15.0	15.0	7.9	25.5	16.7	0.8	22.5	22.5
0.47	474	5.5	18.5	12.8	0.6	15.0	15.0	8.3	18.5	15.6	0.6	15.0	15.0	9.4	25.5	18.2	0.8	22.5	22.5
0.68	684	6.0	18.5	14.8	0.6	15.0	15.0	7.2	25.5	16.1	0.8	22.5	22.5	11.3	25.5	20.1	0.8	22.5	22.5
1.0	105	7.1	18.5	16.0	0.6	15.0	15.0	8.7	25.5	17.6	0.8	22.5	22.5	12.0	30.5	21.0	0.8	27.5	27.5
1.5	155	9.9	18.5	15.6	0.6	15.0	15.0	9.4	30.5	18.5	0.8	27.5	27.5	14.8	30.5	23.8	0.8	27.5	27.5
2.2	225	8.1	25.5	17.0	0.8	22.5	22.5	11.5	30.5	20.5	0.8	27.5	27.5	18.5	30.5	28.0	0.8	27.5	27.5
3.3	335	10.0	25.5	18.8	0.8	22.5	22.5												
4.7	475	12.0	25.5	20.8	0.8	22.5	22.5												
6.8	685	12.7	30.5	21.8	0.8	27.5	27.5												
10.0	106	15.6	30.5	24.7	0.8	27.5	27.5												

F : lead pitch for cut / formed lead wires

Please contact us and let us know the specification you need.