

Features

- Carbon element
- Assortment of resistance tapers
- Push latching shaft
- Flatted, knurled and slotted shaft styles
- Center detent option



PTP90 Series Panel Control w/Push Latching Shaft

Electrical Characteristics

Standard Resistance Range 1K ohms to 1 megohm
 Standard Resistance Tolerance
 R < 250K ohms ±20 %
 R ≥ 250K ohms ±30 %
 End Resistance
 R < 50K ohms 30 ohms max.
 R ≥ 50K ohms 0.1 % of TR max.
 Insulation Resistance @ 250 VDC
 100 megohms min.
 Dielectric Withstanding Voltage
 300 VAC
 Tracking Error (-40 dB to 0 dB) ±3 dB
 Standard Taper Linear, Audio
 Power Rating
 Linear 0.05 watt
 Audio 0.025 watt
 Slider Noise 100 mV max.
 Operating Voltage 50 VAC / 10 VDC

Environmental Characteristics

Operational Life 15,000 cycles
 TR Shift ±15 %
 Operating Temperature Range
 -10 °C to +55 °C
 Resistance to Solder Heat ±5 %
 IP Rating IP 40
 Moisture Sensitivity Level 1
 ESD Classification (HBM) N/A

Mechanical Characteristics

Mechanical Angle 310 ° max.
 Operating Torque 20~250 gf-cm
 Stop Strength 4 kgf-cm max.
 Mounting Torque 10 kgf-cm max.
 Shaft Push Latch Force 40~500 gf
 Push Latch Operating Life
 10,000 cycles
 Soldering Condition
 Manual 300 °C ±5 °C for 3 sec.
 Wave 260 °C ±5 °C for 5 sec.
 Wash Not recommended
 Hardware One flat washer and
 one mounting nut supplied with
 each potentiometer

Product Dimensions

(Shown with Knurled Shaft)

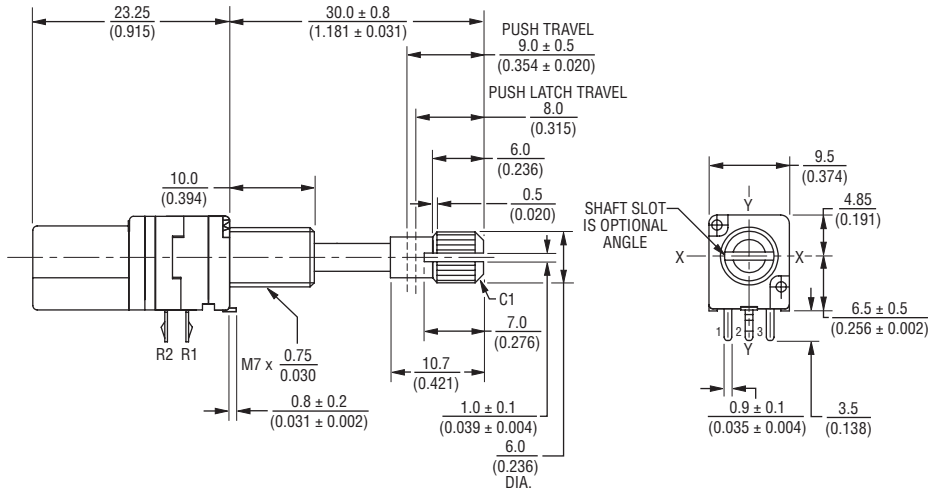

Mounting Hole Detail

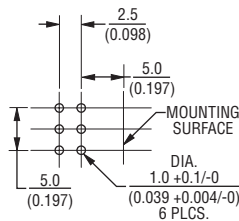

Locating Lug Detail

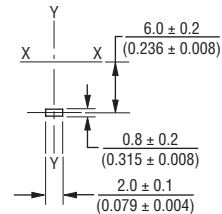

Hardware

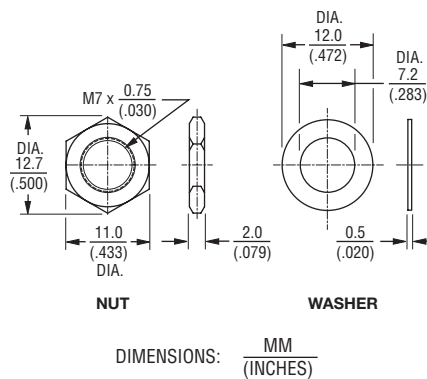

Standard Resistance Table

Resistance (Ohms)	Resistance Code
1,000	102
2,000	202
5,000	502
10,000	103
20,000	203
50,000	503
100,000	104
200,000	204
500,000	504
1,000,000	105

*RoHS Directive 2002/95/EC Jan. 27, 2003 including annex and RoHS Recast 2011/65/EU June 8, 2011.

Specifications are subject to change without notice.

The device characteristics and parameters in this data sheet can and do vary in different applications and actual device performance may vary over time. Users should verify actual device performance in their specific applications.

Applications

- Multimedia sound systems
- Mixers / drum machines / DJ equipment
- Automotive sound systems
- Portable electronics
- Portable appliances

PTP90 Series Panel Control w/Push Latching Shaft

BOURNS®

Additional Shaft Styles

Flatted Shaft

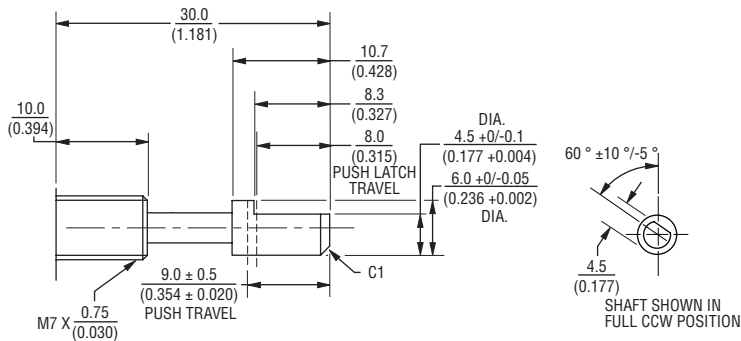

Slotted Shaft

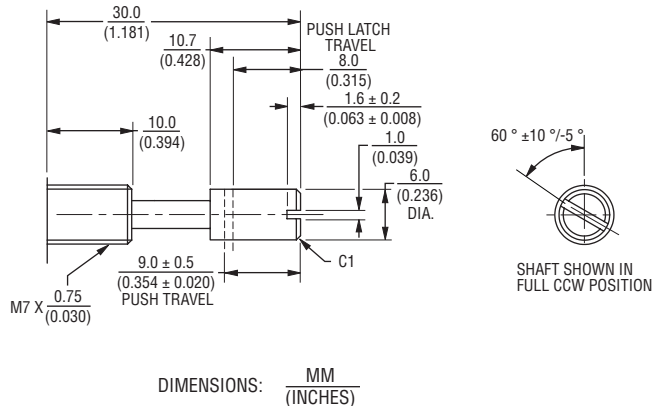

Tapers

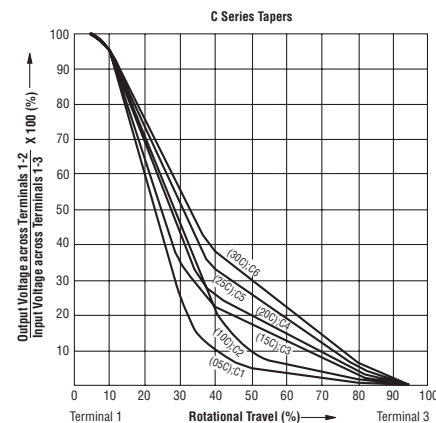
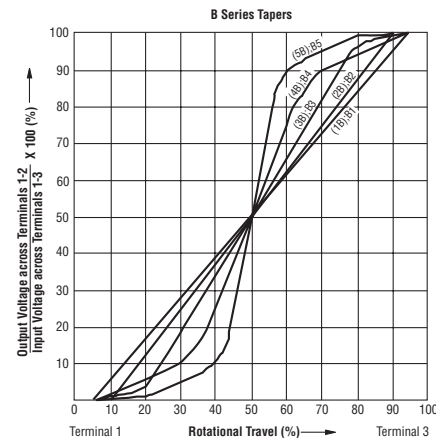
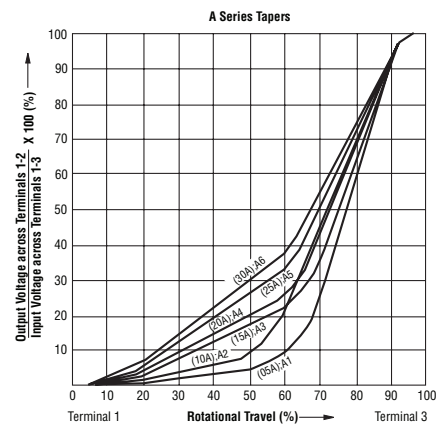

How To Order

PTP90 2 - 0 30 K - 103 B2

Model Number
Designator
PTP90 = Panel Control w/Push Latching Shaft

Number of Sections
1 = Single Gang
2 = Dual Gang

Center Detent
0 = No Detent
1 = Center Detent

Shaft Length (FMS)
30 = 30 mm

Shaft Style
F = Flatted Metal
K = Knurled (18 tooth serrated)
S = Slotted Metal

Resistance Code
(See Standard Resistance Table)

Resistance Taper (See Taper Charts)
Taper Series followed by Curve Number

Schematics

Single Gang

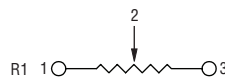

Dual Gang

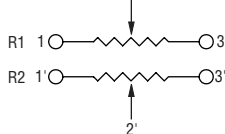

REV. 08/14/17

The device characteristics and parameters in this data sheet can and do vary in different applications and actual device performance may vary over time. Users should verify actual device performance in their specific applications.