

## Features

- Carbon element
- Ganging up to 8 sections available
- Knurled and flatted shaft styles
- Audio taper option
- Tracking error within 3 dB
- RoHS compliant\*



## PTD90 Series - 9 mm Multi-Ganged Potentiometer

### Electrical Characteristics

Standard Resistance Range ..... 1 K ohms to 1 M ohms  
 Total Resistance Tolerance ..... ±10 % or ±20 %  
 Standard Tapers ..... Linear & audio  
 Maximum Operating Voltage ..... 150 VAC, 20 VDC  
 Rated Power  
 Linear Taper ..... 0.05 watts  
 Audio Taper ..... 0.025 watts  
 Noise ..... 100 mV max.  
 Insulation Resistance @ 250 VDC ..... 100 M ohms  
 Dielectric Withstanding Voltage ..... 300 VAC  
 End Resistance ..... 20 ohms max.  
 Tracking Error (-40 dB to 0 dB) ..... ±3 dB

### Environmental Characteristics

Operating Temperature ..... -10 °C to +50 °C  
 Rotational Life ..... 15,000 cycles  
 IP Rating ..... IP 40  
 Moisture Sensitivity Level ..... 1  
 ESD Classification (HBM) ..... N/A

### Mechanical Characteristics

Mechanical Angle ..... 300 ° ±10 °  
 Running Torque ..... 10 to 250 g-cm  
 Stop Strength ..... 4.0 kg-cm  
 Shaft Push/Pull Strength ..... 5.0 kgf min.  
 Shaft Wobble ..... 0.6 x L/20 mm p-p max.  
 Mounting Torque ..... 7.0 kg-cm min.  
 Soldering Condition  
 Manual Soldering  
 ..... 96.5 Sn/3.0 Ag/0.5 Cu solid wire  
 or no-clean rosin cored wire  
 270 °C max. for 3 seconds  
 Wave Soldering  
 ..... 96.5 Sn/3.0 Ag/0.5 Cu solder  
 with no-clean flux  
 260 °C max. for 5 seconds  
 Wash Process ..... Not recommended  
 Mounting Hardware ..... One flat washer  
 and one mounting nut supplied  
 per potentiometer

### Product Dimensions

#### PTD901

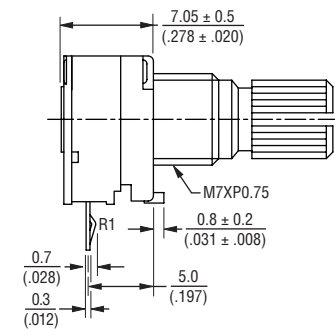

#### RECOMMENDED PCB LAYOUT

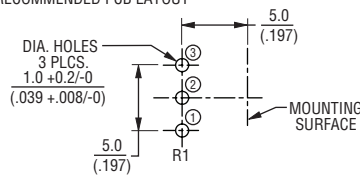

#### SCHEMATIC

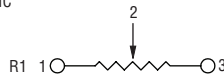

DIMENSIONS:  $\frac{\text{MM}}{\text{(INCHES)}}$

#### PTD902

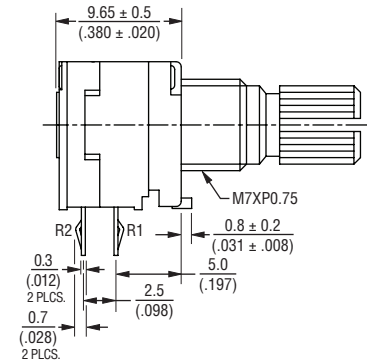

#### RECOMMENDED PCB LAYOUT

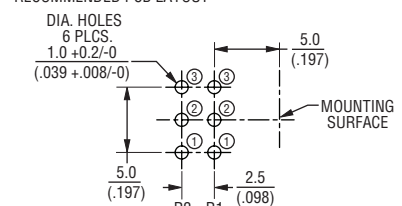

#### SCHEMATIC

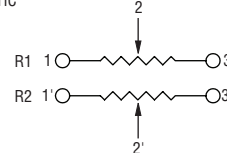

### Derating Curve

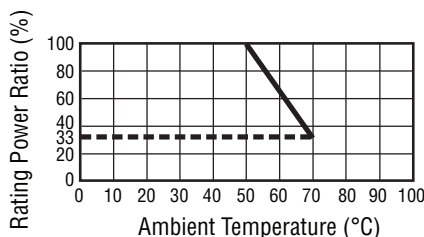

### Standard Resistance Table

Resistance (Ohms)	Resistance Code
1,000	102
2,000	202
5,000	502
10,000	103
20,000	203
50,000	503
100,000	104
200,000	204
500,000	504
1,000,000	105

\*RoHS Directive 2002/95/EC Jan. 27, 2003 including annex and RoHS Recast 2011/65/EU June 8, 2011. Specifications are subject to change without notice.

The device characteristics and parameters in this data sheet can and do vary in different applications and actual device performance may vary over time. Users should verify actual device performance in their specific applications.

## Applications

- Audio/TV sets
- Automotive sound systems
- Amplifiers/mixers/drum machines/synthesizers/DJ equipment
- Multimedia sound systems
- Portable electronics

# PTD90 Series - 9 mm Multi-Ganged Potentiometer

**BOURNS®**

### Product Dimensions

#### PTD904

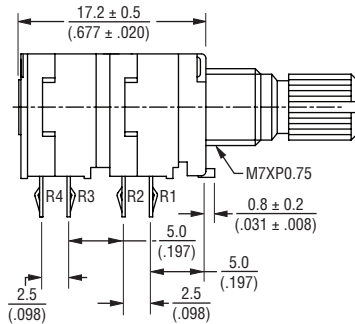

#### RECOMMENDED PCB LAYOUT

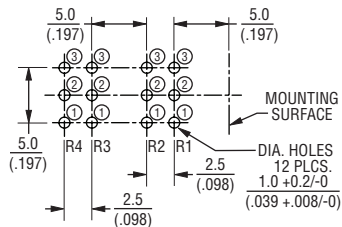

#### SCHEMATIC

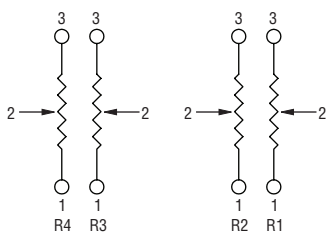

#### PTD906

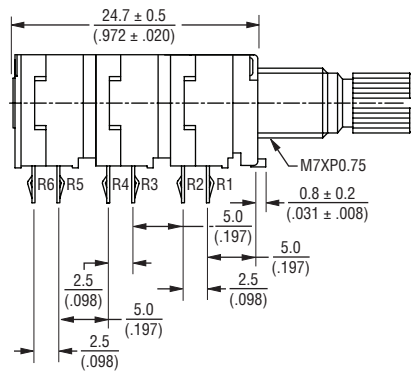

#### RECOMMENDED PCB LAYOUT

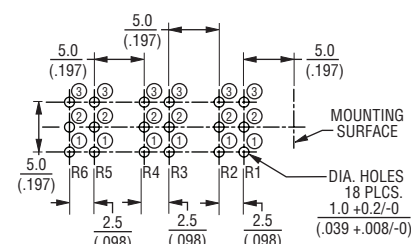

#### SCHEMATIC

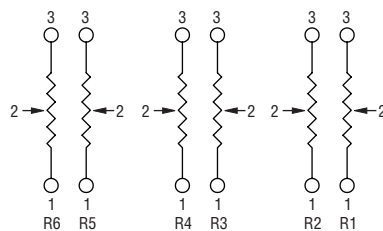

DIMENSIONS:  $\frac{\text{MM}}{\text{(INCHES)}}$

#### PTD908

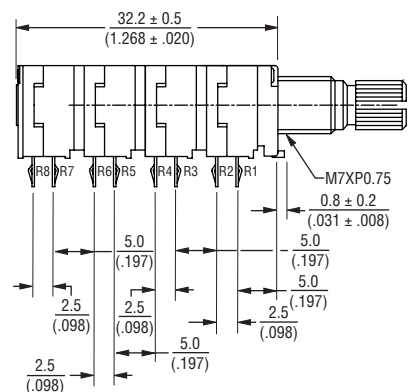

#### RECOMMENDED PCB LAYOUT

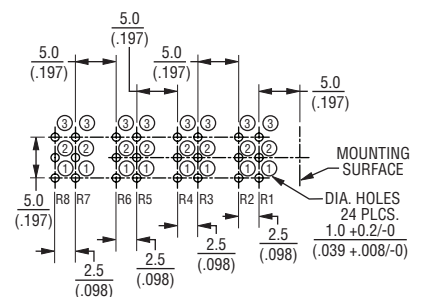

#### SCHEMATIC

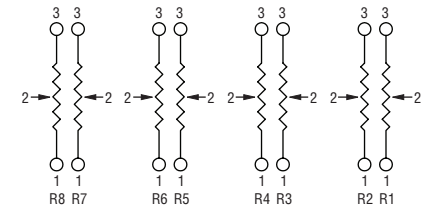

# PTD90 Series - 9 mm Multi-Ganged Potentiometer

# BOURNS®

## Product Dimensions

### SHAFT STYLE "K"

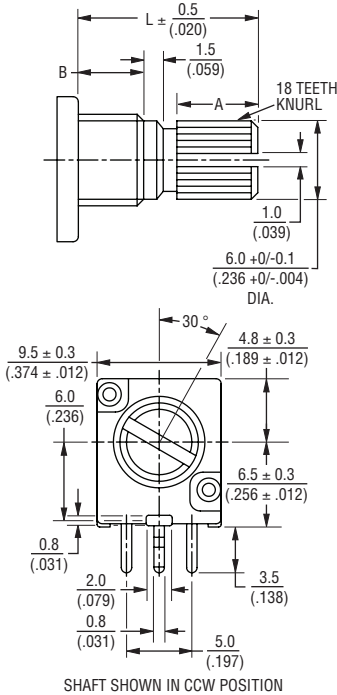

SHAFT SHOWN IN CCW POSITION

L	15 (.591)	20 (.787)	25 (.984)
B	5 (.197)	7 (.276)	10 (.394)
A	6 (.236)	10 (.394)	12 (.472)

DIMENSIONS:  $\frac{\text{MM}}{\text{(INCHES)}}$

### SHAFT STYLE "F"

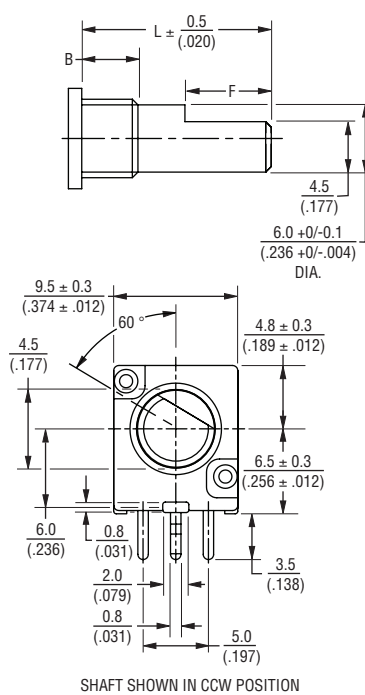

SHAFT SHOWN IN CCW POSITION

L	15 (.591)	20 (.787)	25 (.984)
B	5 (.197)	7 (.276)	10 (.394)
F	7 (.276)	12 (.472)	12 (.472)

## How To Order

**PTD90 1 - 2 0 20 K - B 203**

- Model \_\_\_\_\_
- PTD90 = No Switch
- No. of Sections \_\_\_\_\_
- 1 = 1 Section
  - 2 = 2 Sections
  - 3 = 3 Sections
  - 4 = 4 Sections
  - 5 = 5 Sections
  - 6 = 6 Sections
  - 8 = 8 Sections
- Pin Style \_\_\_\_\_
- 1 = PC Pins vertical/down facing and  $\pm 10\%$  Total Resistance Tolerance
  - 2 = PC Pins vertical/down facing and  $\pm 20\%$  Total Resistance Tolerance
- Center Detent Option \_\_\_\_\_
- 0 = No Detent
  - 2 = Center Detent
- Standard Shaft Length \_\_\_\_\_
- 15 = 15 mm
  - 20 = 20 mm
  - 25 = 25 mm
- Shaft Styles \_\_\_\_\_
- K = Knurled Type Shaft (Metal) 18 Toothed Serration Type
  - F = Flatted Metal Shaft
- Resistance Taper (See Taper Charts) \_\_\_\_\_
- Taper Series followed by Curve Number
- Resistance Code (See Table) \_\_\_\_\_
- Other shaft styles available.

## Tapers

A Series Tapers

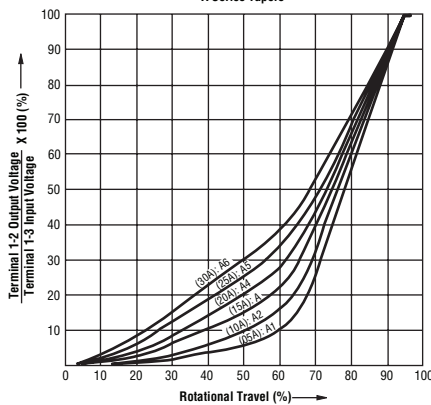

B Series Tapers

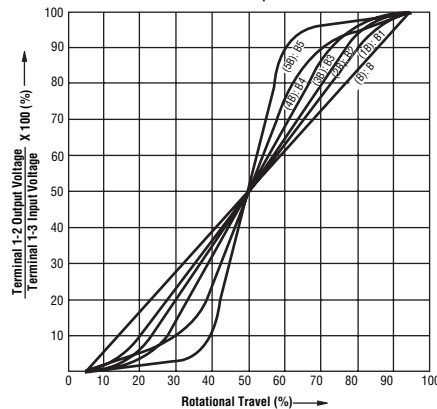

C Series Tapers

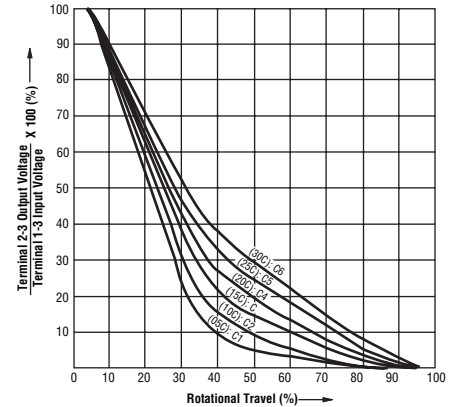

REV. 09/17

Specifications are subject to change without notice.

The device characteristics and parameters in this data sheet can and do vary in different applications and actual device performance may vary over time. Users should verify actual device performance in their specific applications.