



PS7122A-1C, PS7122AL-1C

8-PIN DIP, 250 V BREAK DOWN VOLTAGE
TRANSFER TYPE
2-ch Optical Coupled MOS FET

–NEPOC Series–

DESCRIPTION

The PS7122A-1C and PS7122AL-1C are transfer type solid state relays containing normally open (N.O.) contact and normally close (N.C.) contact on the output side.

They are suitable for analog signal control because of their low offset and high linearity.

The PS7122AL-1C has a surface mount type lead.

FEATURES

- 2 channel type (1 a + 1 b output)
- Low LED operating current ($I_f = 2 \text{ mA}$)
- Designed for AC/DC switching line changer
- Small package (8-pin DIP)
- Low offset voltage
- Ordering number of taping product: PS7122AL-1C-E3, E4: 1 000 pcs/reel
- <R> • Pb-Free product
- <R> • Safety standards
 - UL approved: File No. E72422
 - BSI approved: No. 8245/8246
 - CSA approved: No. CA 101391

APPLICATIONS

- Exchange equipment
- Measurement equipment
- FA/OA equipment

The information in this document is subject to change without notice. Before using this document, please confirm that this is the latest version.

PACKAGE DIMENSIONS (in millimeters)

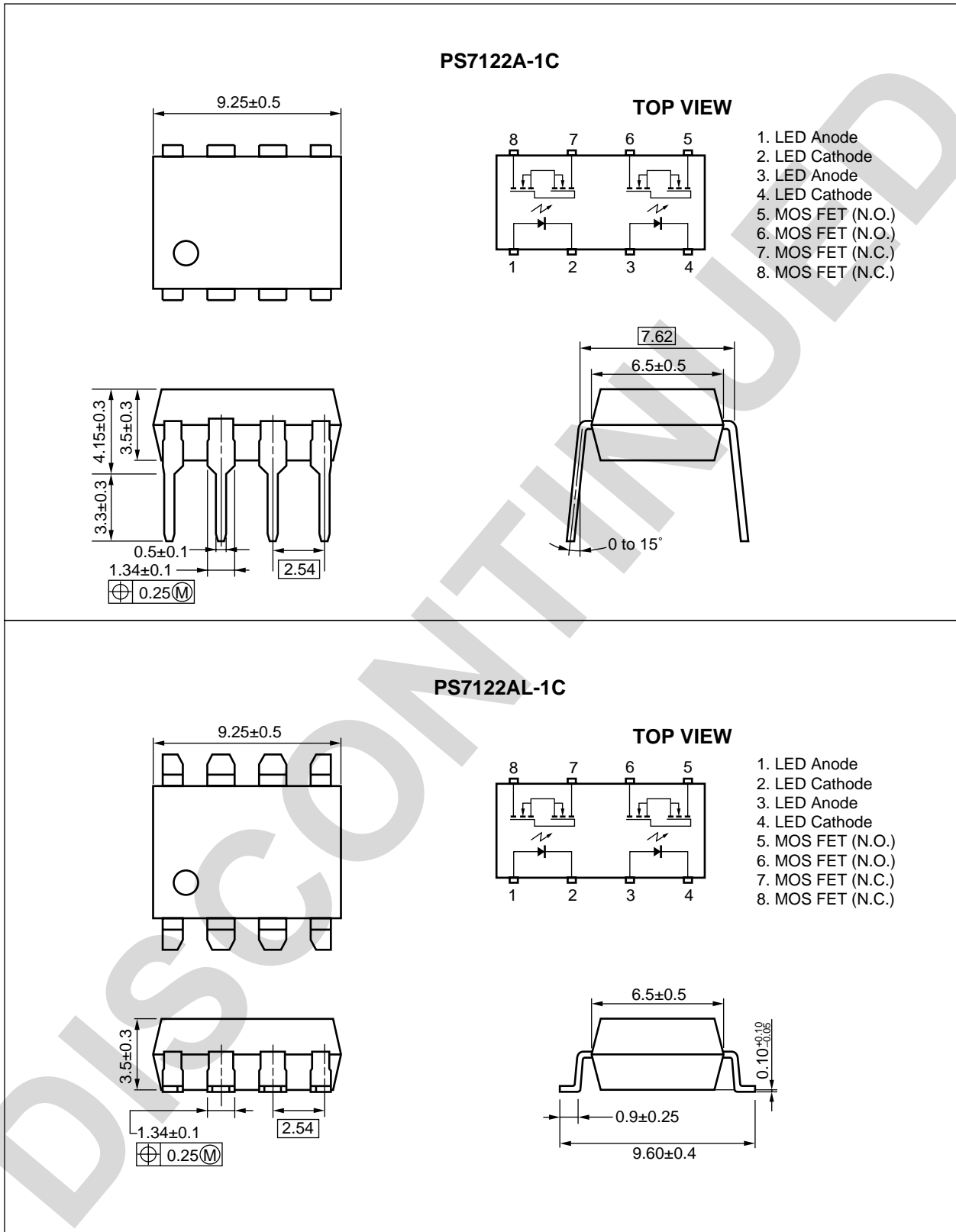

<R> MARKING EXAMPLE

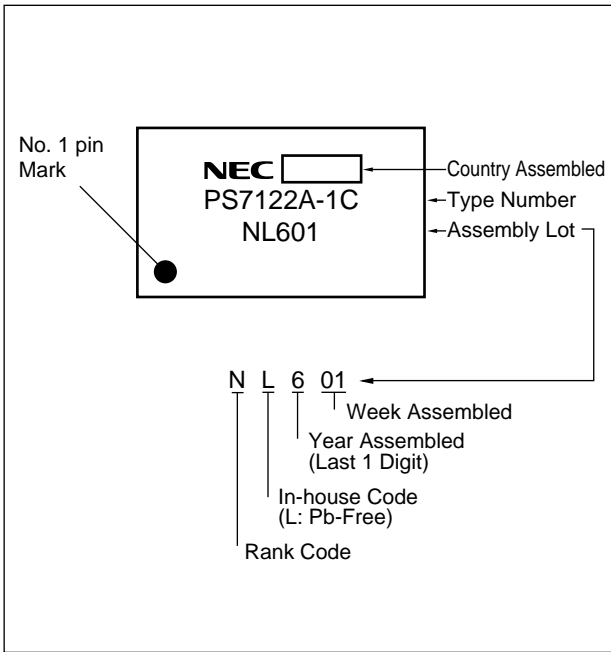

DISCONTINUED

<R> **ORDERING INFORMATION**

Part Number	Order Number	Solder Plating Specification	Packing Style	Safety Standard Approval	Application Part Number ^{*1}
PS7122A-1C	PS7122A-1C-A	Pb-Free	Magazine case 50 pcs	Standard products (UL, BSI, CSA approved)	PS7122A-1C
PS7122AL-1C	PS7122AL-1C-A				
PS7122AL-1C-E3	PS7122AL-1C-E3-A		Embossed Tape 1 000 pcs/reel		
PS7122AL-1C-E4	PS7122AL-1C-E4-A				

*1 For the application of the Safety Standard, following part number should be used.

ABSOLUTE MAXIMUM RATINGS (T_A = 25°C, unless otherwise specified)

Parameter		Symbol	Ratings	Unit
Diode	Forward Current (DC)	I _F	50	mA/ch
	Reverse Voltage	V _R	5.0	V
	Power Dissipation	P _D	50	mW/ch
	Peak Forward Current ^{*1}	I _{FP}	1	A/ch
MOS FET	Break Down Voltage	V _L	250	V
	Continuous Load Current	I _L	200	mA/ch
	Pulse Load Current ^{*2} (AC/DC Connection)	I _{LP}	400	mA/ch
	Power Dissipation	P _D	375	mW/ch
Isolation Voltage ^{*3}		BV	1 500	Vr.m.s.
Total Power Dissipation		P _T	850	mW
Operating Ambient Temperature		T _A	-40 to +85	°C
Storage Temperature		T _{stg}	-40 to +100	°C

*1 PW = 100 μs, Duty Cycle = 1%

*2 PW = 100 ms, 1 shot

*3 AC voltage for 1 minute at T_A = 25°C, RH = 60% between input and output
Pins 1-4 shorted together, 5-8 shorted together.

RECOMMENDED OPERATING CONDITIONS (T_A = 25°C)

Parameter	Symbol	MIN.	TYP.	MAX.	Unit
LED Operating Current	I _F	2	10	20	mA
LED Off Voltage	V _F	0		0.5	V

ELECTRICAL CHARACTERISTICS (T_A = 25°C)

Parameter		Symbol	Conditions	MIN.	TYP.	MAX.	Unit
Diode	Forward Voltage	V _F	I _F = 10 mA		1.2	1.4	V
	Reverse Current	I _R	V _R = 5 V			5.0	μA
MOS FET	Off-state Leakage Current	I _{Loff}	N.O.: I _F = 0 mA, V _D = 250 V		0.03	1.0	μA
			N.C.: I _F = 10 mA, V _D = 250 V				
	Output Capacitance	C _{out}	N.O.: V _D = 0 V, f = 1 MHz		120		pF/ch
			N.C.: I _F = 10 mA, V _D = 0 V, f = 1 MHz		340		
Coupled	LED On-state Current	I _{Fon}	N.O.: I _L = 200 mA			2.0	mA
	LED Off-state Current	I _{Foff}	N.C.: I _L = 200 mA			2.0	mA
	On-state Resistance	R _{on1}	N.O.: I _F = 10 mA, I _L = 10 mA		4.5	8.0	Ω
			N.C.: I _F = 0 mA, I _L = 10 mA				
		R _{on2}	N.O.: I _F = 10 mA, I _L = 200 mA, t ≤ 10 ms				
			N.C.: I _F = 0 mA, I _L = 200 mA, t ≤ 10 ms				
	Turn-on Time ^{*1,2}	t _{on} (N.O.)	I _F = 10 mA, V _O = 5 V, R _L = 500 Ω, PW ≥ 10 ms		0.5	1.5	ms
		t _{on} (N.C.)			0.04	0.2	
	Turn-off Time ^{*1,2}	t _{off} (N.O.)			0.04	0.2	
		t _{off} (N.C.)			0.5	1.5	
Isolation Resistance	R _{I-O}	V _{I-O} = 1.0 kV _{DC}	10 ⁹			Ω	
Isolation Capacitance	C _{I-O}	V = 0 V, f = 1 MHz		1.1		pF/ch	

*1 Test Circuit for Switching Time

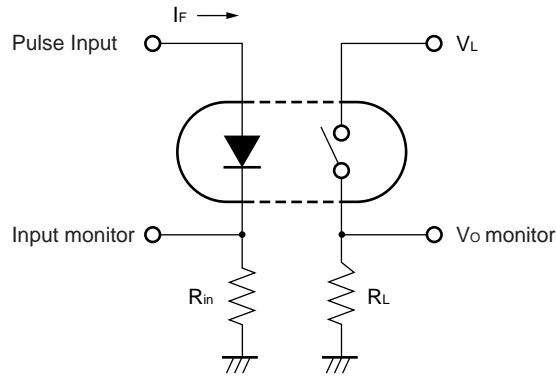

N.O. (between pin 5 and 6)

N.C. (between pin 7 and 8)

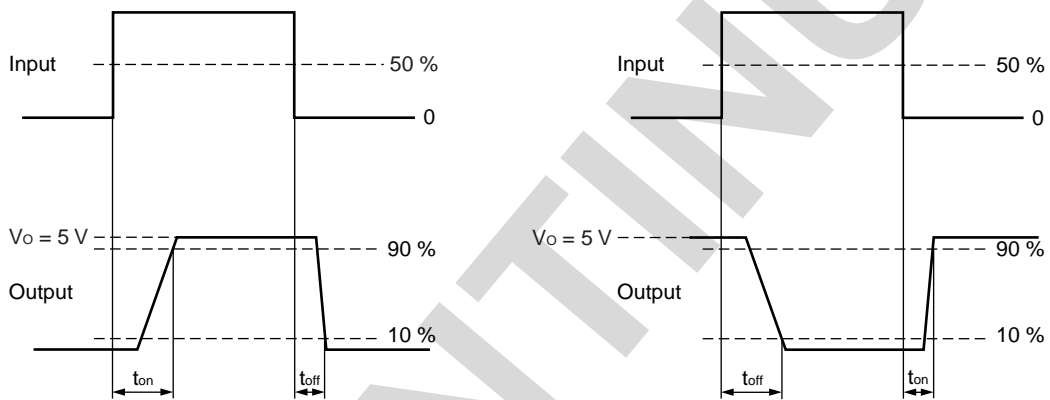

<R>

- *2 The turn-on time and turn-off time are specified as input-pulse width ≥ 10 ms. Be aware that when the device operates with an input-pulse width less than 10 ms, the turn-on time and turn-off time will increase.

TYPICAL CHARACTERISTICS ($T_A = 25^\circ\text{C}$, unless otherwise specified)

MAXIMUM FORWARD CURRENT vs. AMBIENT TEMPERATURE

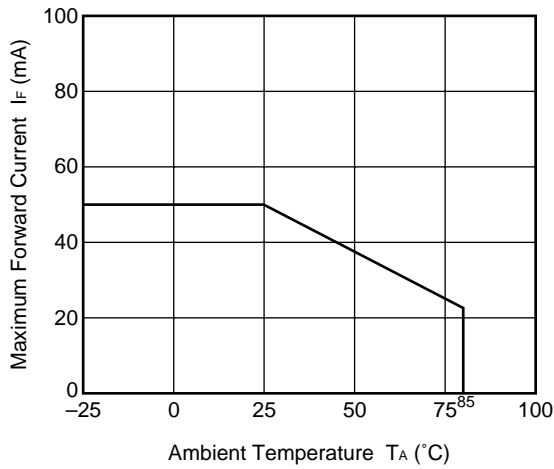

MAXIMUM LOAD CURRENT vs. AMBIENT TEMPERATURE

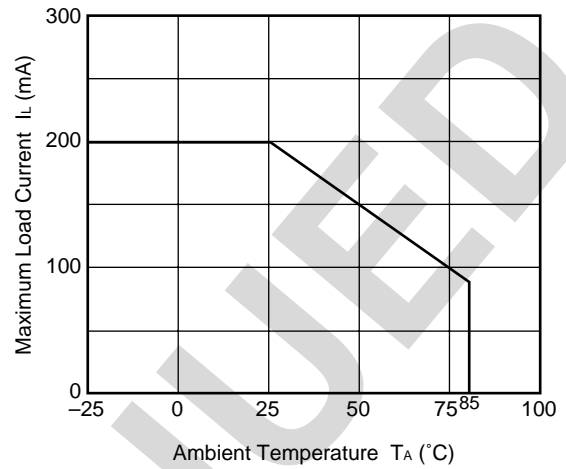

FORWARD VOLTAGE vs. AMBIENT TEMPERATURE

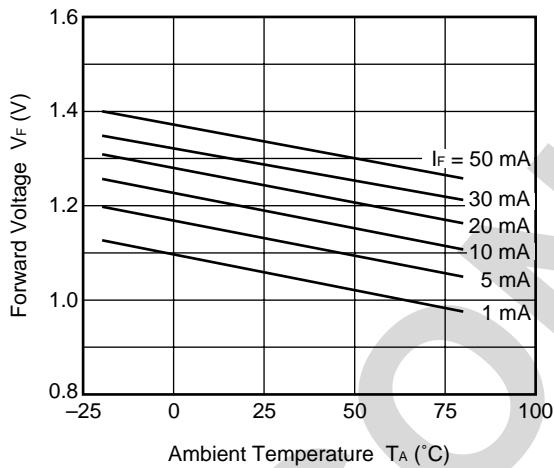

OUTPUT CAPACITANCE vs. APPLIED VOLTAGE

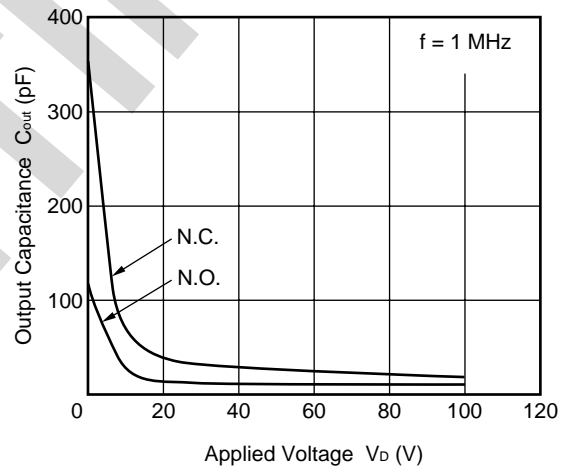

OFF-STATE LEAKAGE CURRENT vs. APPLIED VOLTAGE

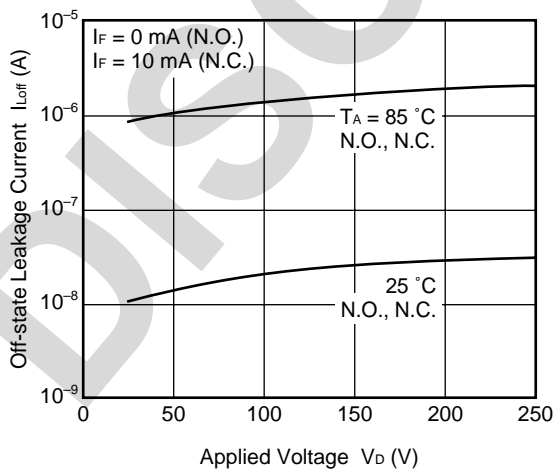

LOAD CURRENT vs. LOAD VOLTAGE

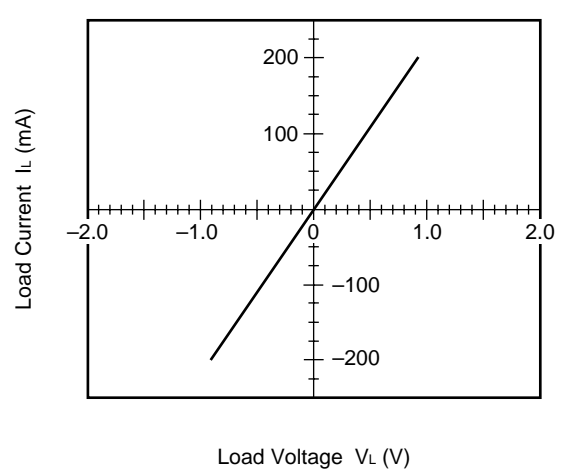

Remark The graphs indicate nominal characteristics.

TURN-ON TIME vs. FORWARD CURRENT

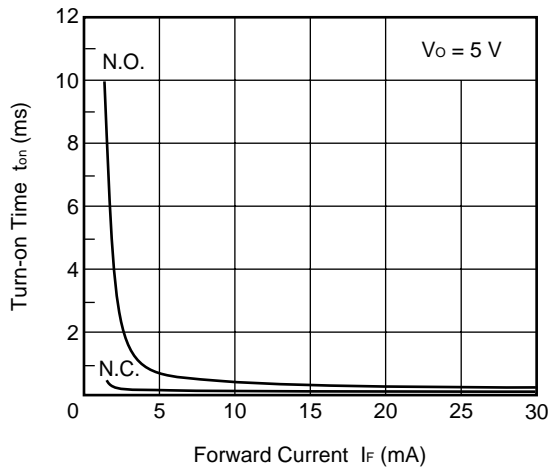

TURN-OFF TIME vs. FORWARD CURRENT

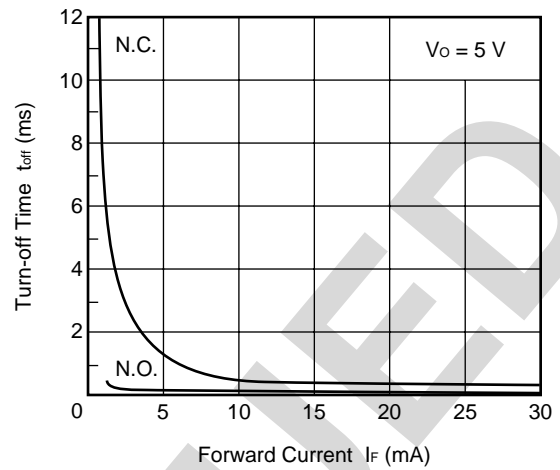

NORMALIZED TURN-ON TIME vs. AMBIENT TEMPERATURE

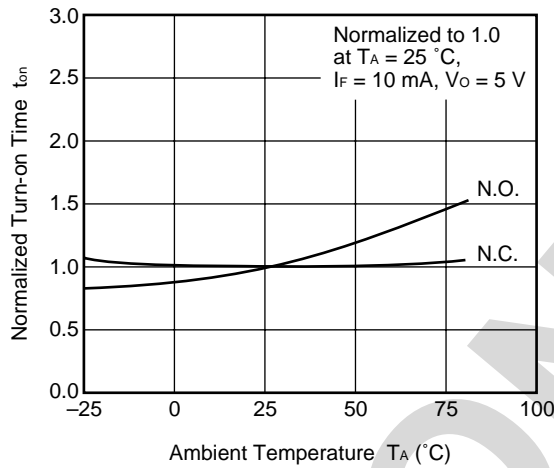

NORMALIZED TURN-OFF TIME vs. AMBIENT TEMPERATURE

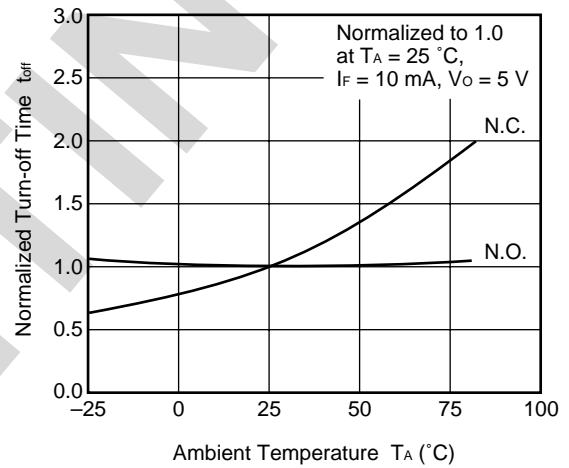

NORMALIZED ON-STATE RESISTANCE vs. AMBIENT TEMPERATURE

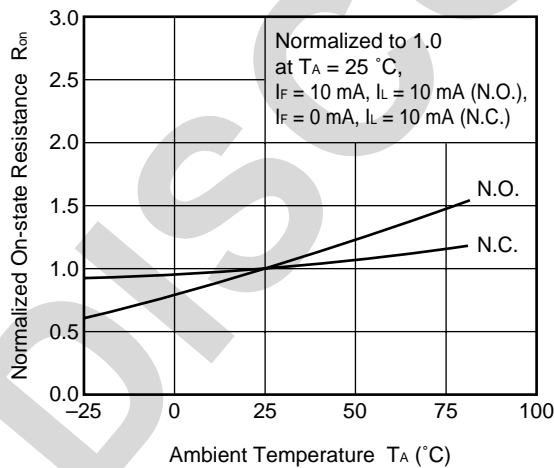

Remark The graphs indicate nominal characteristics.

ON-STATE RESISTANCE (N.O.) DISTRIBUTION

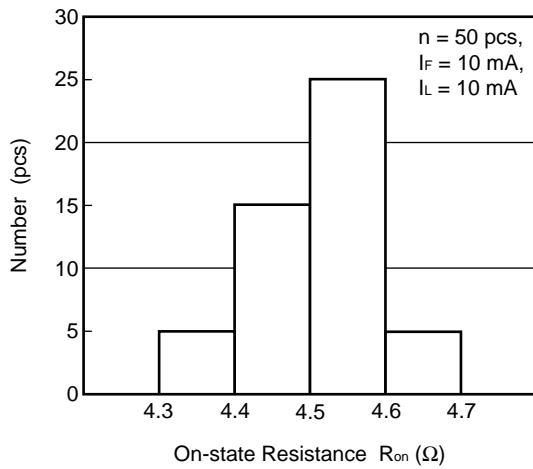

ON-STATE RESISTANCE (N.C.) DISTRIBUTION

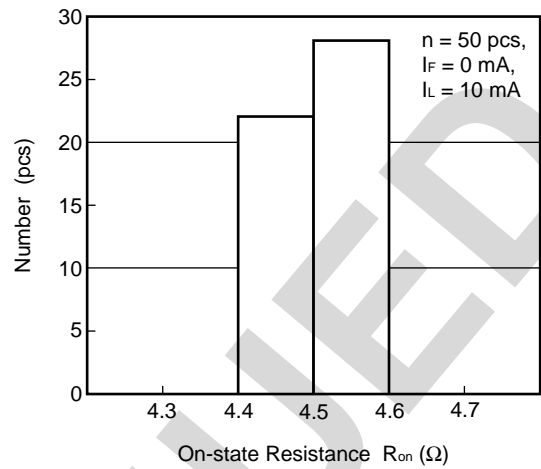

TURN-ON TIME (N.O.) DISTRIBUTION

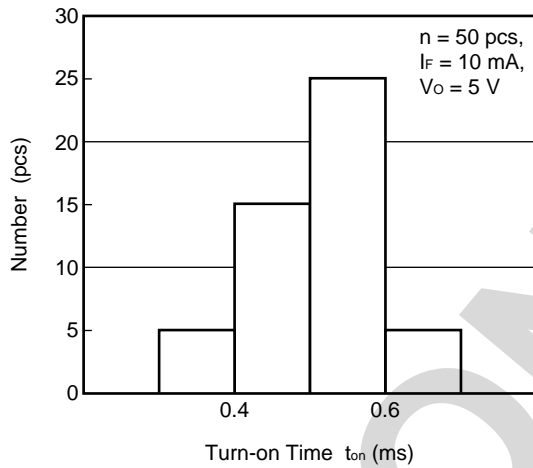

TURN-OFF TIME (N.O.) DISTRIBUTION

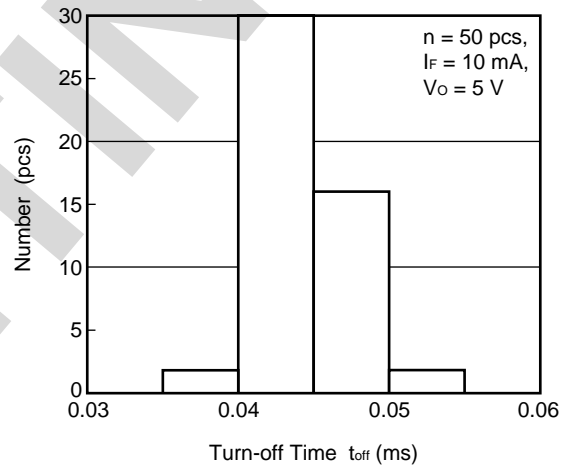

TURN-ON TIME (N.C.) DISTRIBUTION

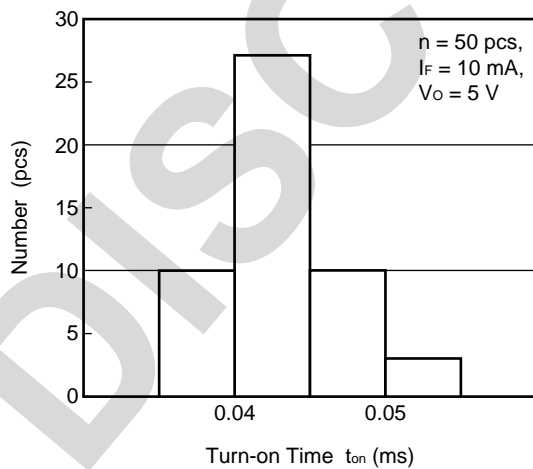

TURN-OFF TIME (N.C.) DISTRIBUTION

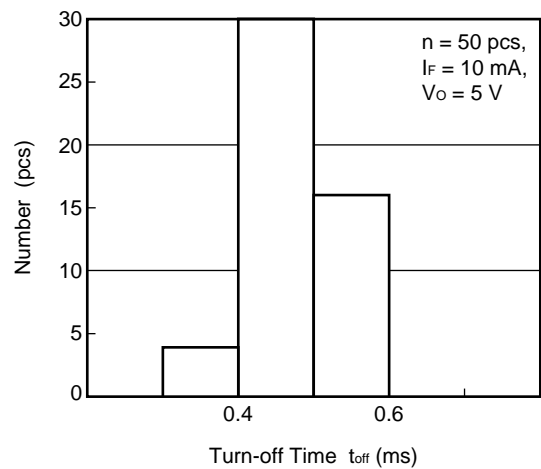

Remark The graphs indicate nominal characteristics.

TAPING SPECIFICATIONS (in millimeters)

Outline and Dimensions (Tape)

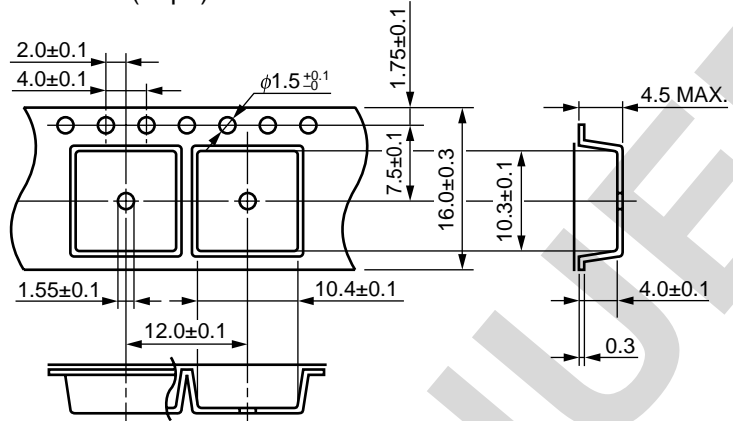

Tape Direction

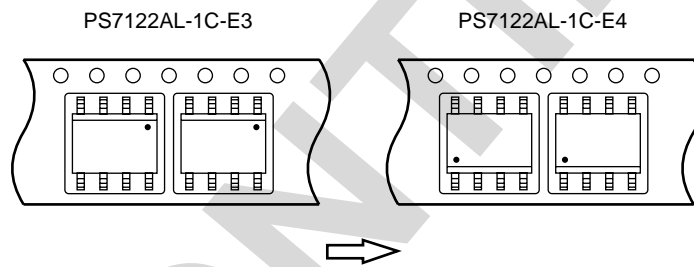

Outline and Dimensions (Reel)

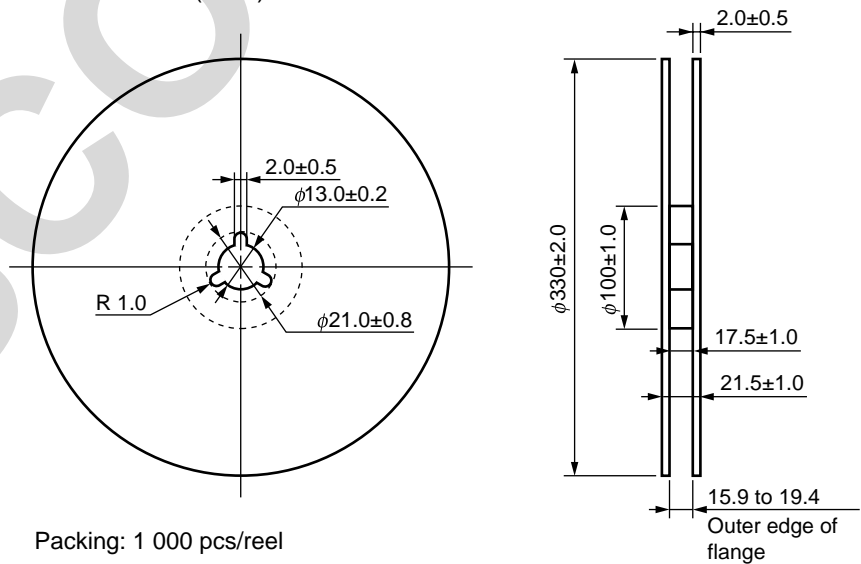

RECOMMENDED SOLDERING CONDITIONS

(1) Infrared reflow soldering

- Peak reflow temperature 260°C or below (package surface temperature)
- Time of peak reflow temperature 10 seconds or less
- Time of temperature higher than 220°C 60 seconds or less
- Time to preheat temperature from 120 to 180°C 120±30 s
- Number of reflows Three
- Flux Rosin flux containing small amount of chlorine (The flux with a maximum chlorine content of 0.2 Wt% is recommended.)

Recommended Temperature Profile of Infrared Reflow

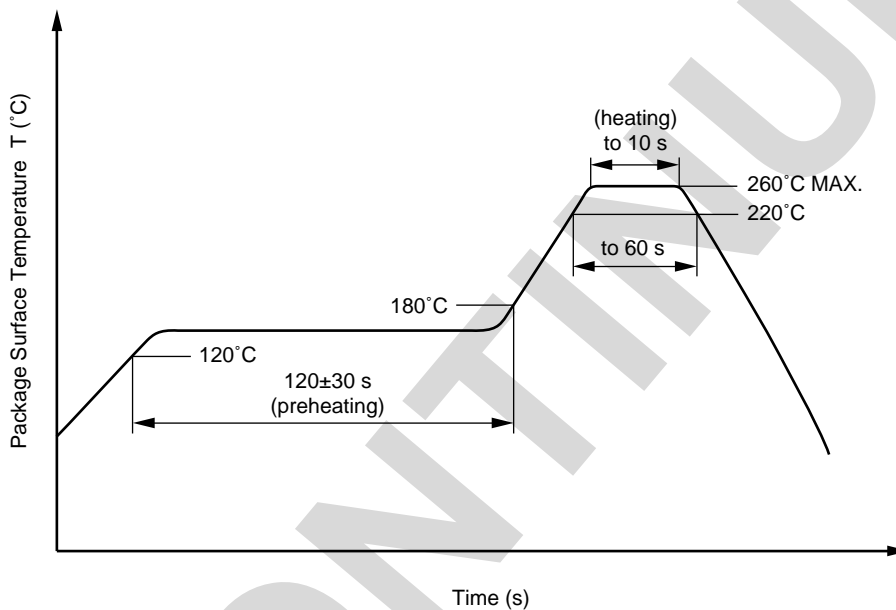

(2) Wave soldering

- Temperature 260°C or below (molten solder temperature)
- Time 10 seconds or less
- Preheating conditions 120°C or below (package surface temperature)
- Number of times One
- Flux Rosin flux containing small amount of chlorine (The flux with a maximum chlorine content of 0.2 Wt% is recommended.)

<R> **(3) Soldering by soldering iron**

- Peak temperature (lead part temperature) 350°C or below
- Time (each pins) 3 seconds or less
- Flux Rosin flux containing small amount of chlorine (The flux with a maximum chlorine content of 0.2 Wt% is recommended.)

- (a) Soldering of leads should be made at the point 1.5 to 2.0 mm from the root of the lead.
- (b) Please be sure that the temperature of the package would not be heated over 100°C.

(4) Cautions

- Fluxes
Avoid removing the residual flux with freon-based and chlorine-based cleaning solvent.

<R> **USAGE CAUTIONS**

1. Protect against static electricity when handling.
2. Avoid storage at a high temperature and high humidity.

DISCONTINUED

- **The information in this document is current as of July, 2006. The information is subject to change without notice. For actual design-in, refer to the latest publications of NEC Electronics data sheets or data books, etc., for the most up-to-date specifications of NEC Electronics products. Not all products and/or types are available in every country. Please check with an NEC Electronics sales representative for availability and additional information.**
- No part of this document may be copied or reproduced in any form or by any means without the prior written consent of NEC Electronics. NEC Electronics assumes no responsibility for any errors that may appear in this document.
- NEC Electronics does not assume any liability for infringement of patents, copyrights or other intellectual property rights of third parties by or arising from the use of NEC Electronics products listed in this document or any other liability arising from the use of such products. No license, express, implied or otherwise, is granted under any patents, copyrights or other intellectual property rights of NEC Electronics or others.
- Descriptions of circuits, software and other related information in this document are provided for illustrative purposes in semiconductor product operation and application examples. The incorporation of these circuits, software and information in the design of a customer's equipment shall be done under the full responsibility of the customer. NEC Electronics assumes no responsibility for any losses incurred by customers or third parties arising from the use of these circuits, software and information.
- While NEC Electronics endeavors to enhance the quality, reliability and safety of NEC Electronics products, customers agree and acknowledge that the possibility of defects thereof cannot be eliminated entirely. To minimize risks of damage to property or injury (including death) to persons arising from defects in NEC Electronics products, customers must incorporate sufficient safety measures in their design, such as redundancy, fire-containment and anti-failure features.
- NEC Electronics products are classified into the following three quality grades: "Standard", "Special" and "Specific".

The "Specific" quality grade applies only to NEC Electronics products developed based on a customer-designated "quality assurance program" for a specific application. The recommended applications of an NEC Electronics product depend on its quality grade, as indicated below. Customers must check the quality grade of each NEC Electronics product before using it in a particular application.

"Standard": Computers, office equipment, communications equipment, test and measurement equipment, audio and visual equipment, home electronic appliances, machine tools, personal electronic equipment and industrial robots.

"Special": Transportation equipment (automobiles, trains, ships, etc.), traffic control systems, anti-disaster systems, anti-crime systems, safety equipment and medical equipment (not specifically designed for life support).

"Specific": Aircraft, aerospace equipment, submersible repeaters, nuclear reactor control systems, life support systems and medical equipment for life support, etc.

The quality grade of NEC Electronics products is "Standard" unless otherwise expressly specified in NEC Electronics data sheets or data books, etc. If customers wish to use NEC Electronics products in applications not intended by NEC Electronics, they must contact an NEC Electronics sales representative in advance to determine NEC Electronics' willingness to support a given application.

(Note)

- (1) "NEC Electronics" as used in this statement means NEC Electronics Corporation and also includes its majority-owned subsidiaries.
- (2) "NEC Electronics products" means any product developed or manufactured by or for NEC Electronics (as defined above).

<p>Caution</p>	<p>GaAs Products</p>	<p>This product uses gallium arsenide (GaAs). GaAs vapor and powder are hazardous to human health if inhaled or ingested, so please observe the following points.</p> <ul style="list-style-type: none"> • Follow related laws and ordinances when disposing of the product. If there are no applicable laws and/or ordinances, dispose of the product as recommended below. <ol style="list-style-type: none"> 1. Commission a disposal company able to (with a license to) collect, transport and dispose of materials that contain arsenic and other such industrial waste materials. 2. Exclude the product from general industrial waste and household garbage, and ensure that the product is controlled (as industrial waste subject to special control) up until final disposal. • Do not burn, destroy, cut, crush, or chemically dissolve the product. • Do not lick the product or in any way allow it to enter the mouth.
-----------------------	----------------------	---

► **For further information, please contact**

NEC Compound Semiconductor Devices Hong Kong Limited

E-mail: contact@ncsd-hk.necel.com

Hong Kong Head Office TEL: +852-3107-7303 FAX: +852-3107-7309
 Taipei Branch Office TEL: +886-2-8712-0478 FAX: +886-2-2545-3859
 Korea Branch Office TEL: +82-2-558-2120 FAX: +82-2-558-5209

NEC Electronics (Europe) GmbH <http://www.eu.necel.com/>

TEL: +49-211-6503-0 FAX: +49-211-6503-1327

California Eastern Laboratories, Inc. <http://www.cel.com/>

TEL: +1-408-988-3500 FAX: +1-408-988-0279

Compound Semiconductor Devices Division

NEC Electronics Corporation

URL: <http://www.ncsd.necel.com/>