

FEATURES

- 2.4-5.5Vdc input voltage range
- Programmable output voltage from 0.6-3.3Vdc
- High power conversion efficiency at 93.5%
- Inspectable Land Grid Array
- Drives up to 300 μ F ceramic capacitive loads
- On/Off control
- Optional Sequence/Tracking operation
- Outstanding thermal derating performance
- Over temperature and over current protection
- Certified to UL/EN/IEC 60950-1 safety, 2nd Edition
- RoHS-6 hazardous substance compliance

PRODUCT OVERVIEW

The OKL-T/6-W5 series are non-isolated Point-of-Load (PoL) DC/DC power converters for embedded applications. Featuring inspectable Land Grid Array (LGA) format, the OKL-T/6-W5 measures only 0.48 x 0.48 x 0.283 inches max. (12.2 x 12.2 x 7.2 mm max.).

The wide input range is 2.4 to 5.5 Volts DC. The maximum output current is 6 Amps. Based on fixed-frequency synchronous buck converter switching topology, the high power conversion

efficient Point of Load (PoL) module features programmable output voltage and On/Off control. These converters also include under voltage lock out (UVLO), output short circuit protection, over-current and over temperature protections.

An optional sequence/tracking feature allows power sequencing of PoL's. These units are certified to all standard UL/EN/IEC 60950-1 safety certifications (2nd Edition) and RoHS-6 hazardous substance compliance.

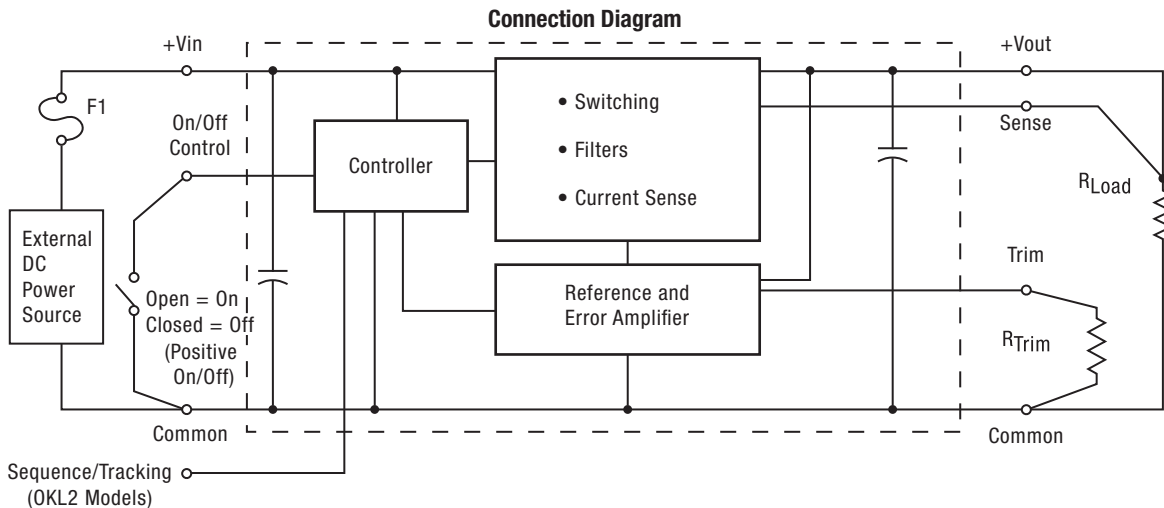

Figure 1. OKL-T/6-W5

Note: Murata Power Solutions strongly recommends an external input fuse, F1. See specifications.



PERFORMANCE SPECIFICATIONS SUMMARY AND ORDERING GUIDE

Model Number	Output						Input				Efficiency		On/Off Logic	Seq/Track	Package—Pinout P83
	Vout (Volts) ①	Iout (Amps, max.)	Power (Watts)	R/N (mV p-p) Max. ④	Regulation (max.)		Vin nom. (Volts)	Range (Volts)	Iin, no load (mA) ⑤	Iin, full load (Amps) ②	Min.	Typ.			Case C83 inches (mm)
					Line	Load									
OKL-T/6-W5P-C	0.6-3.3	6	19.8	25	±0.35%	±0.35%	5	2.4-5.5	25	4.24	91.5%	93.5%	Pos.	no	0.48x0.48x0.283 max (12.2x12.2x7.2) max
OKL-T/6-W5N-C	0.6-3.3	6	19.8	25	±0.35%	±0.35%	5	2.4-5.5	25	4.24	91.5%	93.5%	Neg.	no	0.48x0.48x0.283 max (12.2x12.2x7.2) max
OKL2-T/6-W5P-C	0.6-3.3	6	19.8	25	±0.35%	±0.35%	5	2.4-5.5	25	4.24	91.5%	93.5%	Pos.	yes	0.48x0.48x0.283 max (12.2x12.2x7.2) max
OKL2-T/6-W5N-C	0.6-3.3	6	19.8	25	±0.35%	±0.35%	5	2.4-5.5	25	4.24	91.5%	93.5%	Neg.	yes	0.48x0.48x0.283 max (12.2x12.2x7.2) max

- ① The output range (50% load) is limited by Vin. See detailed specs for full conditions.
 - ② All specifications are at nominal line voltage, Vout=nominal (3.3V for W5 models) and full load, +25 deg.C, unless otherwise noted. Output capacitors are 10 µF ceramic. Input cap is 22 µF. See detailed specifications.
 - ③ Use adequate ground plane and copper thickness adjacent to the converter.
 - ④ Ripple and Noise (R/N) are shown at Vout=1V. See specs for details.
 - ⑤ No load input current is shown at Vout = 3.3V.
- I/O caps are necessary for our test equipment and may not be needed for your application.

PART NUMBER STRUCTURE

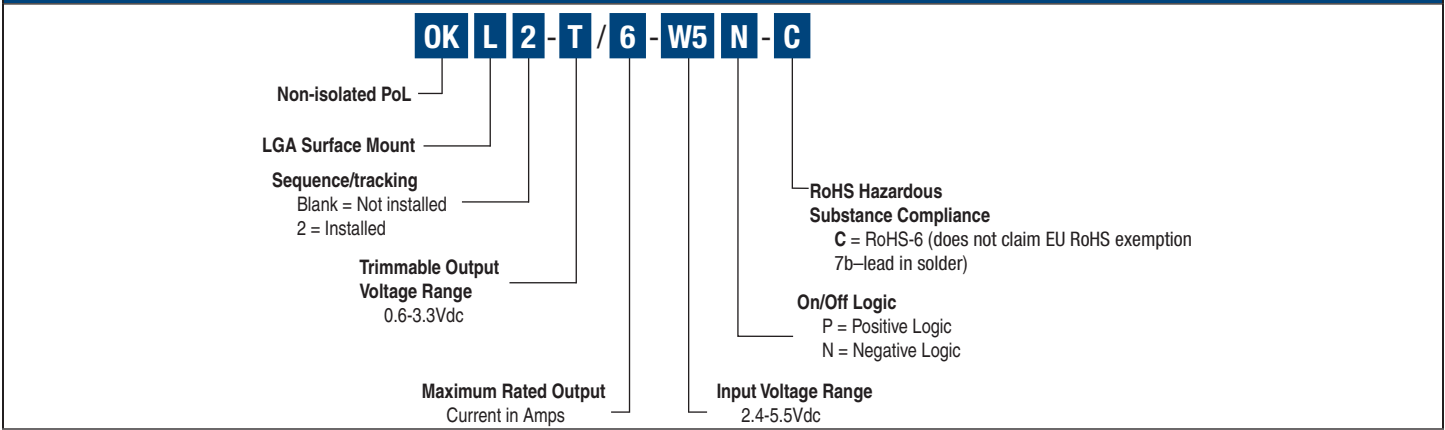

Product Label

Because of the small size of these products, the product label contains a character-reduced code to indicate the model number and manufacturing date code. Not all items on the label are always used. Please note that the label differs from the product photograph. Here is the layout of the label:

Model Number	Product Code
OKL-T/6-W5P-C	L01006
OKL-T/6-W5N-C	L00006
OKL2-T/6-W5P-C	L21006
OKL2-T/6-W5N-C	L20006

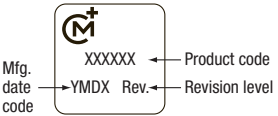

Figure 2. Label Artwork Layout

The label contains three rows of information:

- First row – Murata Power Solutions logo
- Second row – Model number product code (see table)
- Third row – Manufacturing date code and revision level

The manufacturing date code is four characters:

- First character – Last digit of manufacturing year, example 2009
- Second character – Month code (1 through 9 = Jan-Sep; 0, N, D = Oct, Nov, Dec)
- Third character – Day code (1 through 9 = 1 to 9, 10 = 0 and 11 through 31 = A through Z)
- Fourth character – Manufacturing information

Performance and Functional Specifications

See Note 1

Input	
Input Voltage Range	See Ordering Guide and Note 7.
Isolation	Not isolated
Start-Up Voltage	2.05 V
Undervoltage Shutdown (see Note 15)	1.92 V
Overvoltage Shutdown	None
Reflected (Back) Ripple Current (Note 2)	TBD mA pk-pk
Internal Input Filter Type	Capacitive
Recommended External Fuse	TBD
Reverse Polarity Protection	None, Install external fuse
Input Current:	
Full Load Conditions	See Ordering Guide
Inrush Transient	TBD A ² Sec.
Shutdown Mode (Off, UV, OT)	1 mA
Output in Short Circuit	10 mA
Low Line (Vin=Vmin)	4.68 A (Vout = 3.3V)
Remote On/Off Control (Note 5)	
Negative Logic	ON = Open pin or -0.2V to Vin -1.6V max. OFF = Vin -0.8V min. to +Vin max.
Positive Logic	ON = Open pin (internally pulled up) or +1.2V to +Vin max. OFF = -0.3V to +0.3V max. or ground
Current	TBD
Tracking/Sequencing (optional)	
Slew Rate	See technical note on page 15
Tracking accuracy, rising input	2 Volts per millisecond, max. Vout = ±100 mV of Sequence In
Tracking accuracy, falling input	Vout = ±100 mV of Sequence In
Output	
Output Power	20.2W max.
Output Voltage Range	See Ordering Guide
Minimum Loading	No minimum load
Accuracy (50% load, untrimmed)	±2 % of Vnominal
Voltage Output Range (Note 13)	See Ordering Guide
Overvoltage Protection (Note 16)	None
Temperature Coefficient	TBD
Ripple/Noise (20 MHz bandwidth)	See Ordering Guide and note 8
Line/Load Regulation	See Ordering Guide and note 10
Efficiency	See Ordering Guide
Maximum Capacitive Loading (Note 14)	
Cap-ESR=0.001 to 0.01 Ohms	300 µF
Cap-ESR >0.01 Ohms	TBD
Current Limit Inception (Note 6)	
(98% of Vout setting, after warm up)	12 Amps
Short Circuit Mode	
Short Circuit Current Output	10 mA
Protection Method	Hiccup autorecovery upon overload removal. (Note 17)
Short Circuit Duration	Continuous, no damage (output shorted to ground)
Prebias Startup	Converter will start up if the external output voltage is less than Vnominal.

Dynamic Characteristics	
Dynamic Load Response	50µSec max. to within ±2% of final value
(50-100% load step, di/dt=1A/µSec)	(Note 1)
Peak Deviation	±350 mV
Start-Up Time	6 mSec for Vout=nominal (Vin On)
(Vin on or On/Off to Vout regulated)	6 mSec for Vout=nominal (Remote On/Off)
Switching Frequency	600 KHz ± 100 kHz

Environmental		
Calculated MTBF (hours)	OKL Models	OKL2 Models
Telecordia method (4a)	5,573,000	5,341,000
Calculated MTBF (hours)		
MIL-HDBK-217N2 method (4b)	4,383,000	4,221,000
Operating Temperature Range (Ambient, all output ranges)		
See derating curves	-40 to +85 °C. with derating (Note 9)	
Storage Temperature Range	-55 to +125 °C.	
Thermal Protection/Shutdown	Included in PWM	
MSL Rating	2	
Relative Humidity	To 85%/+85 °C., non-condensing	

Physical	
Outline Dimensions	See Mechanical Specifications
Weight	0.06 ounces (1.6 grams)
Plating Thickness	Gold overplate 1.18µ" (0.03µm) on Nickel subplate 118.1µ" (3.0µm)
Safety	Certified to UL/cUL 60950-1, CSA-C22.2 No. 60950-1, IEC/EN 60950-1, 2nd Edition
Restriction of Hazardous Substances	RoHS-6 (does not claim EU RoHS exemption 7b-lead in solder)

Absolute Maximum Ratings	
Input Voltage (Continuous or transient)	0 V. to +6 Volts max.
On/Off Control	0 V. min. to +Vin max.
Input Reverse Polarity Protection	None, Install external fuse
Output Current (Note 7)	Current-limited. Devices can withstand a sustained short circuit without damage. The outputs are not intended to accept appreciable reverse current.
Storage Temperature	-55 to +125 °C.
Lead Temperature	See soldering specifications
Absolute maximums are stress ratings. Exposure of devices to greater than any of any of these conditions may adversely affect long-term reliability. Proper operation under conditions other than those listed in the Performance/Functional Specifications Table is not implied nor recommended.	

Specification Notes:

- Specifications are typical at +25 °C, Vin=nominal (+5V), Vout=nominal (+3.3V), full load, external caps and natural convection unless otherwise indicated. Extended tests at full power must supply substantial forced airflow. All models are tested and specified with external 10µF ceramic output capacitors and a 22 µF external input capacitor. All capacitors are low ESR types. These capacitors are necessary to accommodate our test equipment and may not be required to achieve specified performance in your applications. However, Murata Power Solutions recommends installation of these capacitors. All models are stable and regulate within spec under no-load conditions.
- Input Back Ripple Current is tested and specified over a 5 Hz to 20 MHz bandwidth. Input filtering is Cin=2 x 100 µF ceramic, Cbus=1000 µF electrolytic, Lbus=1 µH.
- Note that Maximum Power Derating curves indicate an average current at nominal input voltage. At higher temperatures and/or lower airflow, the DC/DC converter will tolerate brief full current outputs if the total RMS current over time does not exceed the Derating curve.

Specification Notes, Cont.:

- (4a) Mean Time Before Failure is calculated using the Telcordia (Belcore) SR-332 Method 1, Case 3, ground fixed conditions, Tpcboard=+25 °C, full output load, natural air convection.
- (4b) Mean Time Before Failure is calculated using the MIL-HDBK-217N2 method, ground benign, +25°C., full output load, natural convection.
- (5) The On/Off Control Input should use either a switch or an open collector/open drain transistor referenced to -Input Common. A logic gate may also be used by applying appropriate external voltages which do not exceed +Vin.
- (6) Short circuit shutdown begins when the output voltage degrades approximately 2% from the selected setting.
- (7) Please observe the voltage input and output specifications in the Voltage Range Graph on page 17.
- (8) Output noise may be further reduced by adding an external filter. At zero output current, the output may contain low frequency components which exceed the ripple specification. The output may be operated indefinitely with no load.
- (9) All models are fully operational and meet published specifications, including "cold start" at -40° C.
- (10) Regulation specifications describe the deviation as the line input voltage or output load current is varied from a nominal midpoint value to either extreme.
- (11) Other input or output voltage ranges will be reviewed under scheduled quantity special order.
- (12) Maximum PC board temperature is measured with the sensor in the center of the converter.
- (13) Do not exceed maximum power specifications when adjusting the output trim.
- (14) The maximum output capacitive loads depend on the the Equivalent Series Resistance (ESR) of the external output capacitor and, to a lesser extent, the distance and series impedance to the load. Larger caps will reduce output noise but may change the transient response. Newer ceramic caps with very low ESR may require lower capacitor values to avoid instability. Thoroughly test your capacitors in the application. Please refer to the Output Capacitive Load Application Note.
- (15) Do not allow the input voltage to degrade lower than the input undervoltage shutdown voltage at all times. Otherwise, you risk having the converter turn off. The undervoltage shutdown is not latching and will attempt to recover when the input is brought back into normal operating range.
- (16) The outputs are not intended to sink appreciable reverse current.
- (17) "Hiccup" overcurrent operation repeatedly attempts to restart the converter with a brief, full-current output. If the overcurrent condition still exists, the restart current will be removed and then tried again. This short current pulse prevents overheating and damaging the converter. Once the fault is removed, the converter immediately recovers normal operation.

PERFORMANCE DATA, OKL-T/6-W5

Efficiency vs. Line Voltage and Load Current @ +25°C (V_{OUT} = 3.3V)

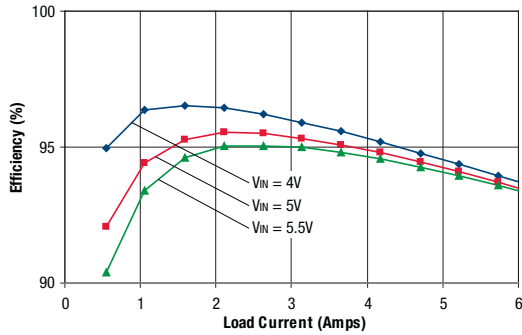

Maximum Current Temperature Derating at Sea Level (VIN = 5V, V_{OUT} = 3.3V).

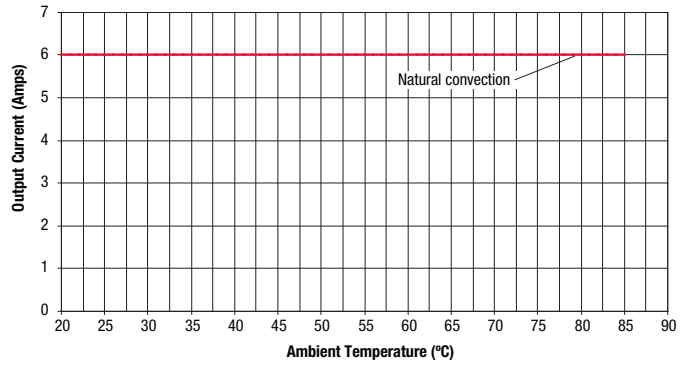

Output Ripple and Noise (VIN=5V, V_{OUT}=3.3V, I_{OUT}=6A, ScopeBW=20MHz)

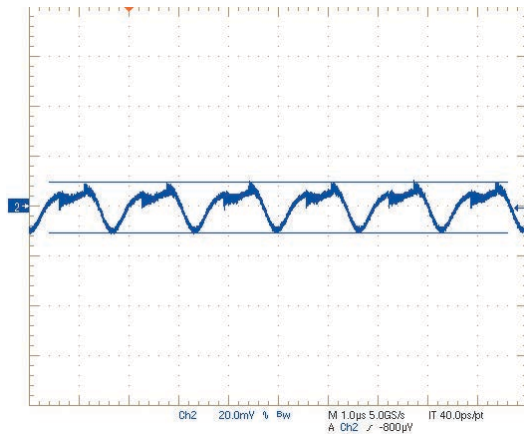

On/Off Enable Startup (VIN=5V, V_{OUT}=3.3V, I_{OUT}=6A, C_{LOAD}=0)
Trace 4=Enable, Trace 2=V_{OUT}

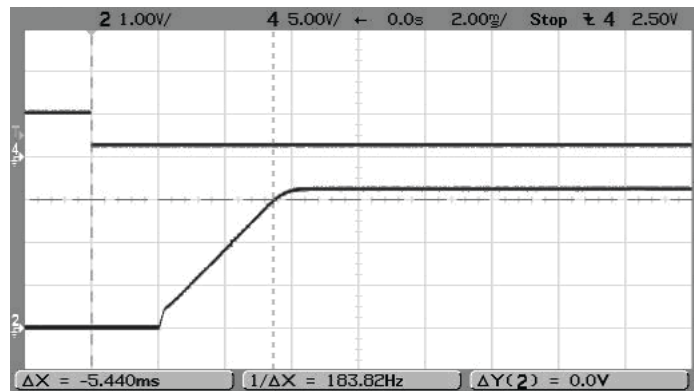

Step Load Transient Response (VIN=5V, V_{OUT}=3.3V, I_{OUT}=6A to 3A)
Trace 2=V_{OUT}, 200 mV/div. Trace 4=I_{OUT}, 5A/div.

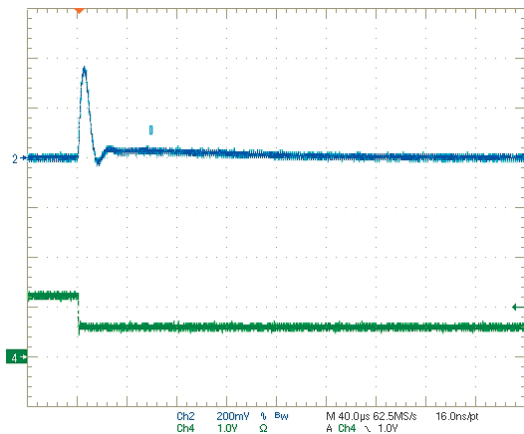

Step Load Transient Response (VIN=5V, V_{OUT}=3.3V, I_{OUT}=3A to 6A)
Trace 2=V_{OUT}, 200 mV/div. Trace 4=I_{OUT}, 5A/div.

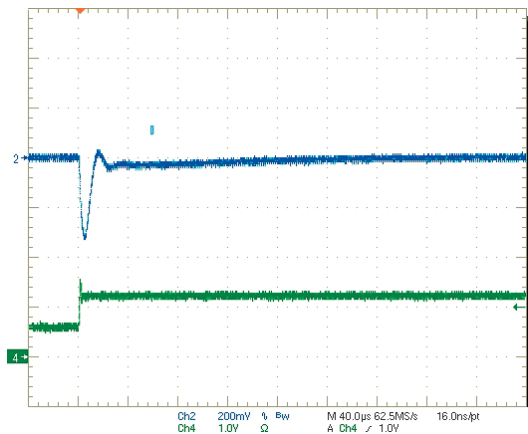

PERFORMANCE DATA, OKL-T/6-W5

Efficiency vs. Line Voltage and Load Current @ +25°C (V_{out} = 2.5V)

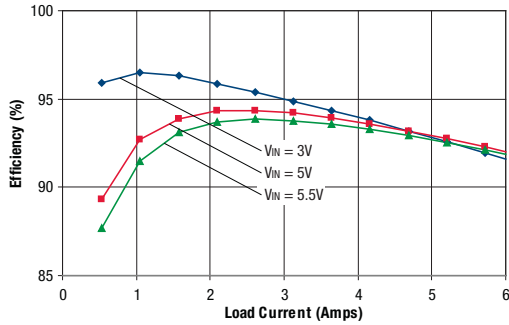

Maximum Current Temperature Derating at Sea Level (V_{in} = 5V, V_{out} = 2.5V).

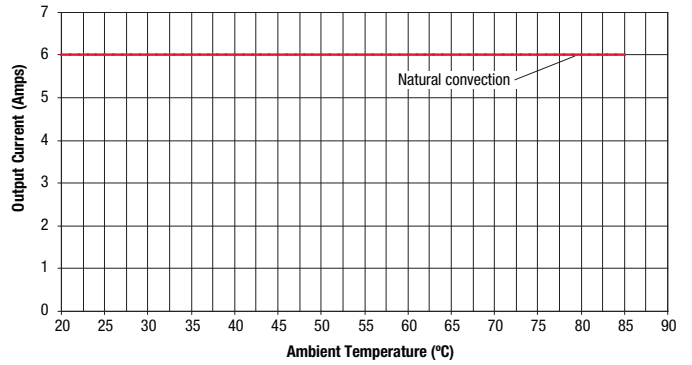

Output Ripple and Noise (V_{in}=5V, V_{out}=2.5V, I_{out}=6A, ScopeBW=20MHz)

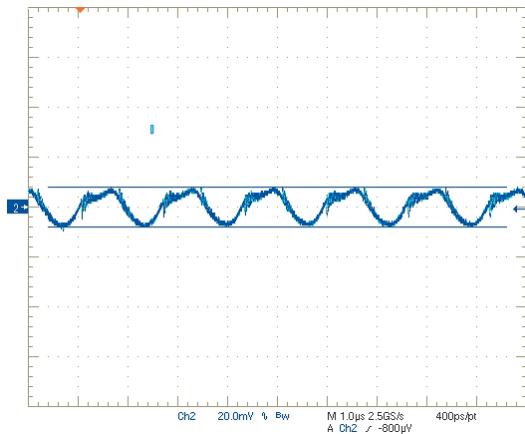

On/Off Enable Startup (V_{in}=5V, V_{out}=2.5V, I_{out}=6A, Cload=0)
Trace 4=Enable, Trace 2=Vout

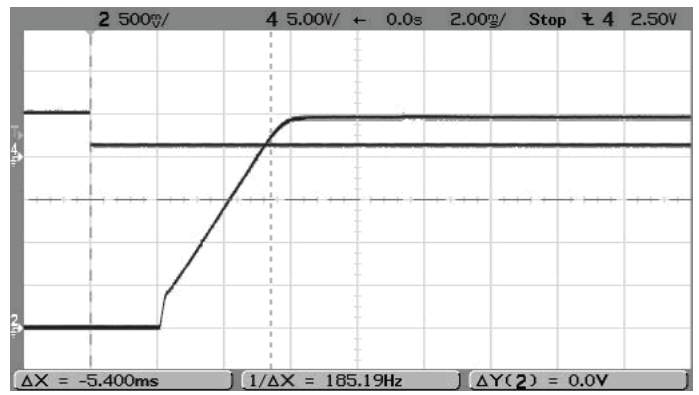

Step Load Transient Response (V_{in}=5V, V_{out}=2.5V, I_{out}=6A to 3A)
Trace 2=Vout, 200 mV/div. Trace 4=Iout, 5A/div.

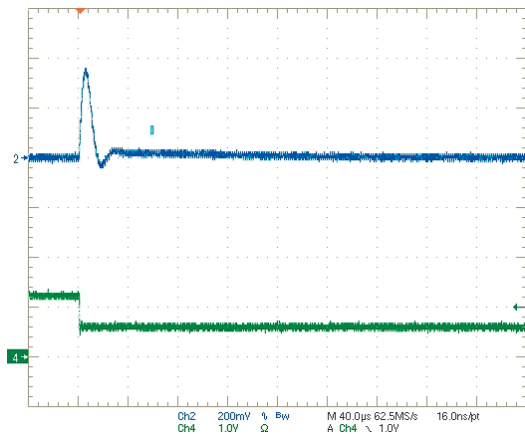

Step Load Transient Response (V_{in}=5V, V_{out}=2.5V, I_{out}=3A to 6A)
Trace 2=Vout, 200 mV/div. Trace 4=Iout, 5A/div.

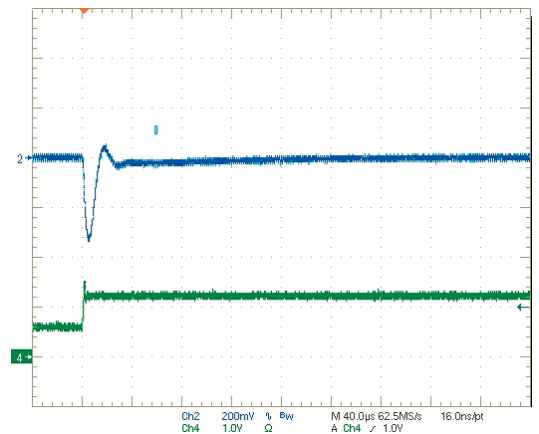

PERFORMANCE DATA, OKL-T/6-W5

Efficiency vs. Line Voltage and Load Current @ +25°C (V_{out} = 1.8V)

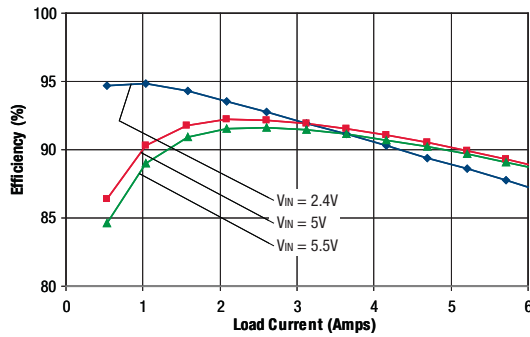

Maximum Current Temperature Derating at Sea Level (V_{in} = 5V, V_{out} = 1.8V).

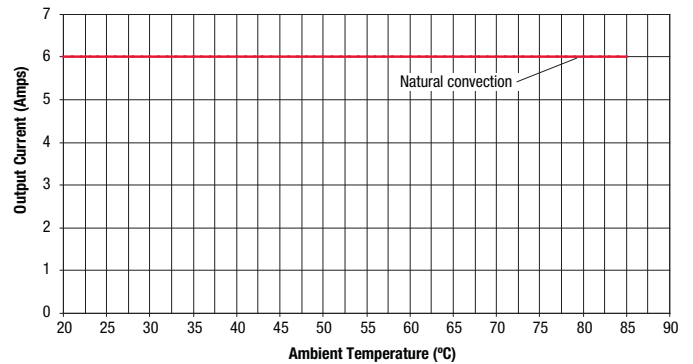

Output Ripple and Noise (V_{in}=5V, V_{out}=1.8V, I_{out}=6A, ScopeBW=20MHz)

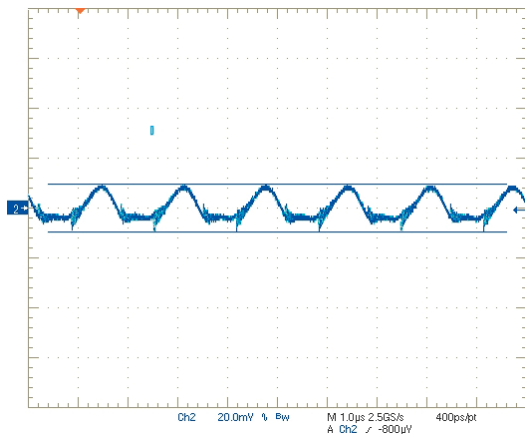

On/Off Enable Startup (V_{in}=5V, V_{out}=1.8V, I_{out}=6A, Cload=0)
Trace 4=Enable, Trace 2=V_{out}

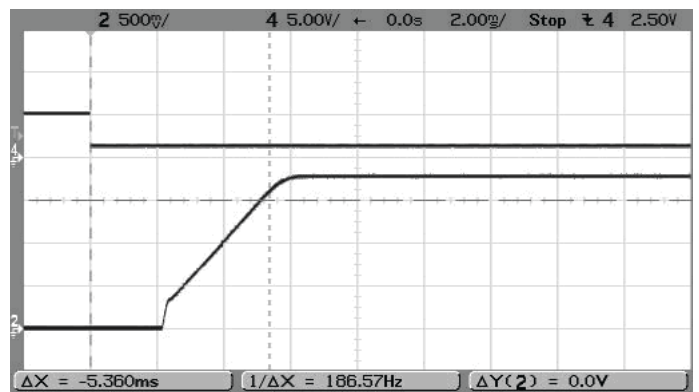

Step Load Transient Response (V_{in}=5V, V_{out}=1.8V, I_{out}=6A to 3A)
Trace 2=V_{out}, 200 mV/div. Trace 4=I_{out}, 5A/div.

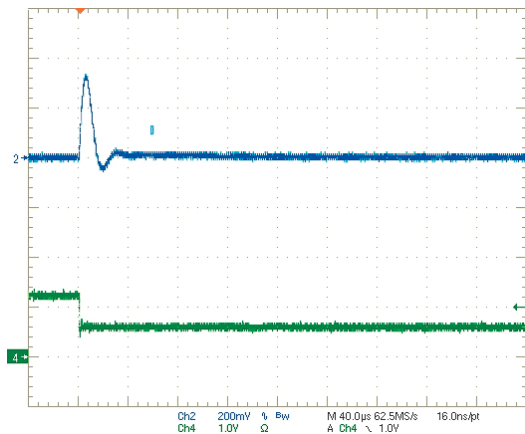

Step Load Transient Response (V_{in}=5V, V_{out}=1.8V, I_{out}=3A to 6A)
Trace 2=V_{out}, 200 mV/div. Trace 4=I_{out}, 5A/div.

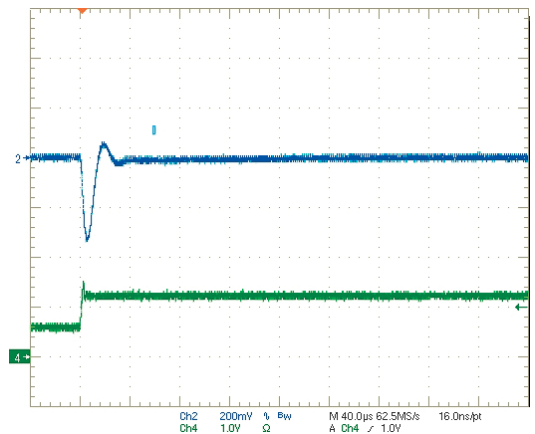

PERFORMANCE DATA, OKL-T/6-W5

Efficiency vs. Line Voltage and Load Current @ +25°C (V_{out} = 1.5V)

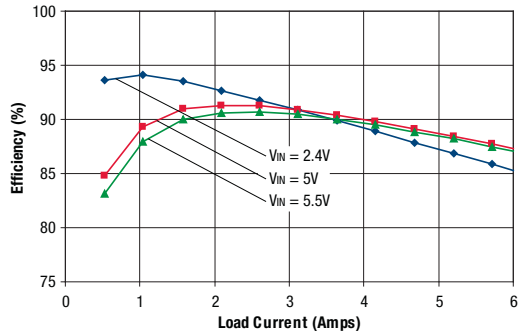

Maximum Current Temperature Derating at Sea Level (VIN = 5V, V_{out} = 1.5V).

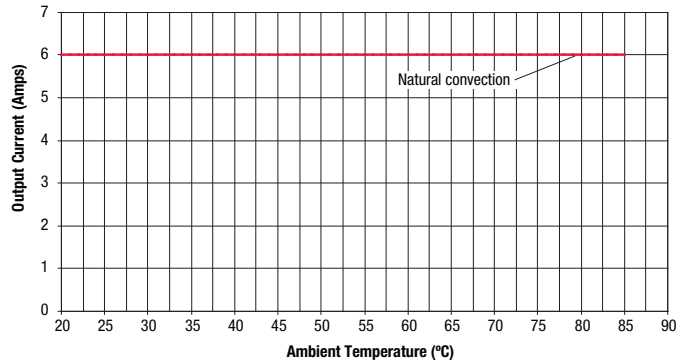

Output Ripple and Noise (VIN=5V, Vout=1.5V, Iout=6A, ScopeBW=20MHz)

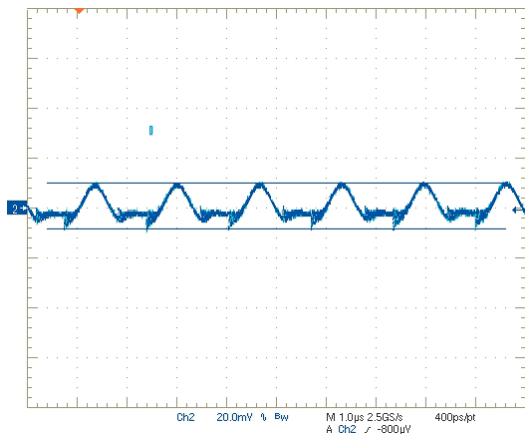

On/Off Enable Startup (VIN=5V, Vout=1.5V, Iout=6A, Cload=0)
 Trace 4=Enable, Trace2=Vout

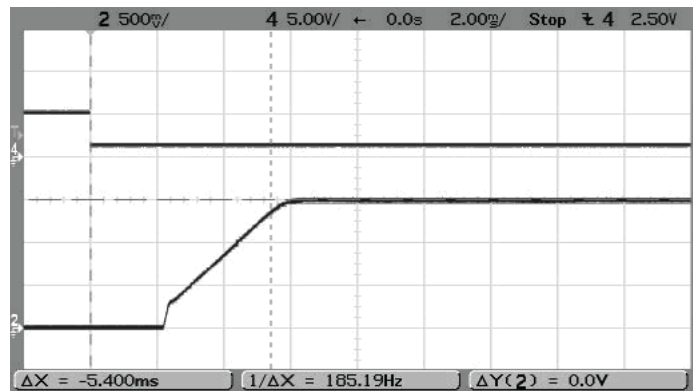

Step Load Transient Response (VIN=5V, Vout=1.5V, Iout=6A to 3A)
 Trace 2=Vout, 200 mV/div. Trace 4=Iout, 5A/div.

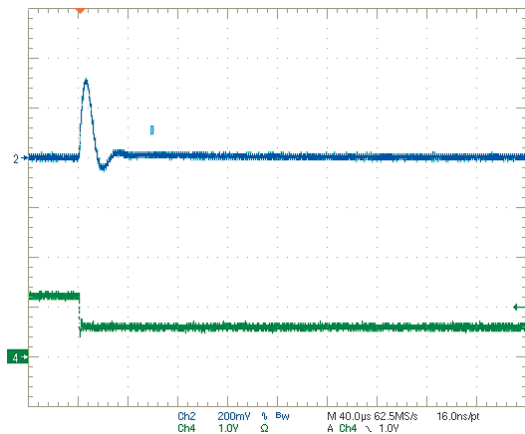

Step Load Transient Response (VIN=5V, Vout=1.5V, Iout=3A to 6A)
 Trace 2=Vout, 200 mV/div. Trace 4=Iout, 5A/div.

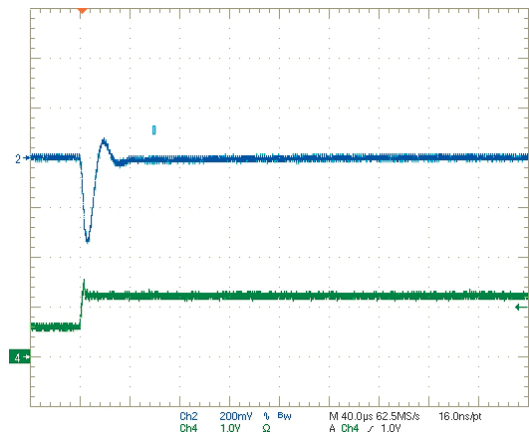

PERFORMANCE DATA, OKL-T/6-W5

Efficiency vs. Line Voltage and Load Current @ +25°C (V_{OUT} = 1.2V)

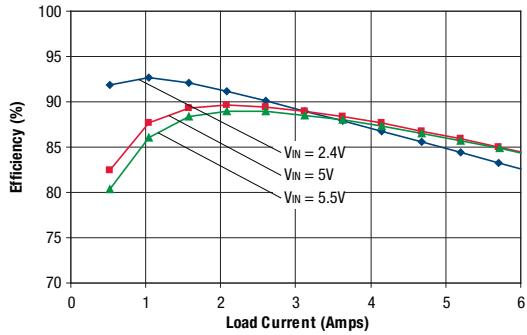

Maximum Current Temperature Derating at Sea Level (V_{IN} = 5V, V_{OUT} = 1.2V).

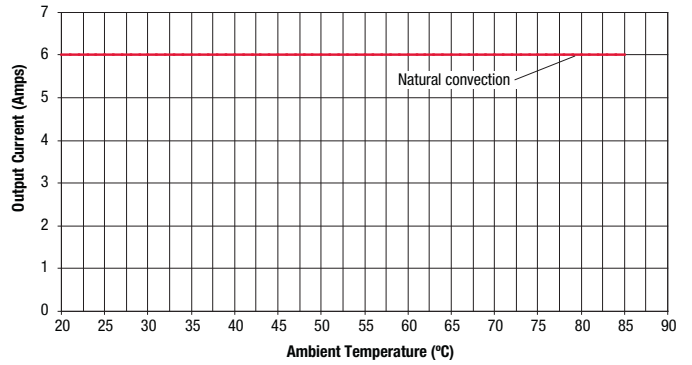

Output Ripple and Noise (V_{in}=5V, V_{out}=1.2V, I_{out}=6A, ScopeBW=20MHz)

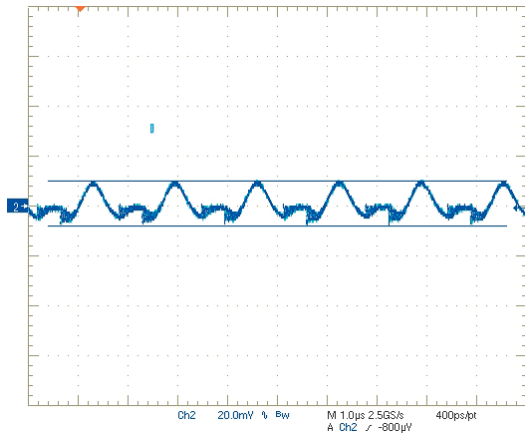

On/Off Enable Startup (V_{in}=5V, V_{out}=1.2V, I_{out}=6A, Cload=0)
Trace 4=Enable, Trace 2=V_{out}

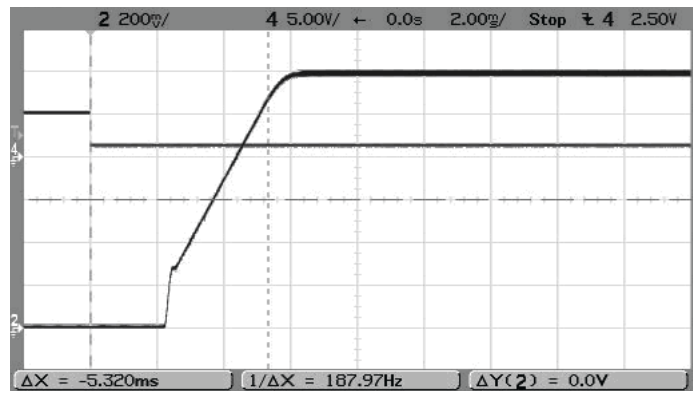

Step Load Transient Response (V_{in}=5V, V_{out}=1.2V, I_{out}=6A to 3A)
Trace 2=V_{out}, 200 mV/div. Trace 4=I_{out}, 5A/div.

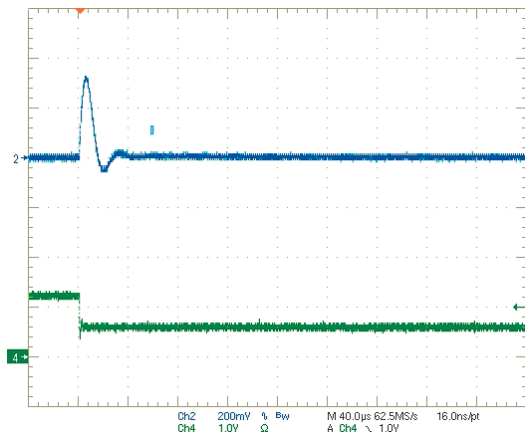

Step Load Transient Response (V_{in}=5V, V_{out}=1.2V, I_{out}=3A to 6A)
Trace 2=V_{out}, 200 mV/div. Trace 4=I_{out}, 5A/div.

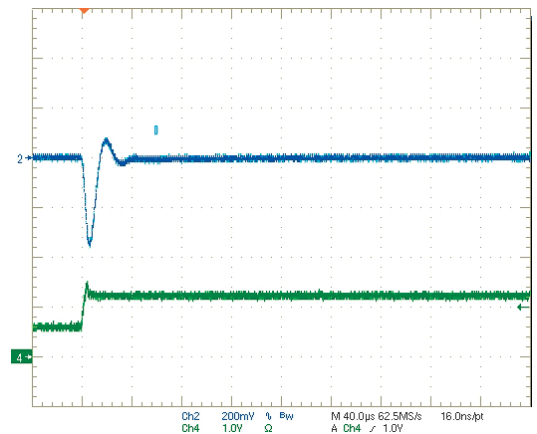

PERFORMANCE DATA, OKL-T/6-W5

Efficiency vs. Line Voltage and Load Current @ +25°C (V_{out} = 1.0V)

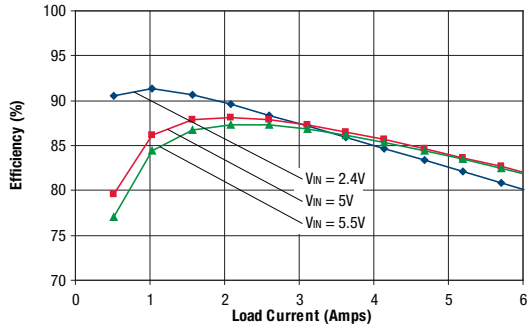

Maximum Current Temperature Derating at Sea Level (V_{in} = 5V, V_{out} = 1.0V).

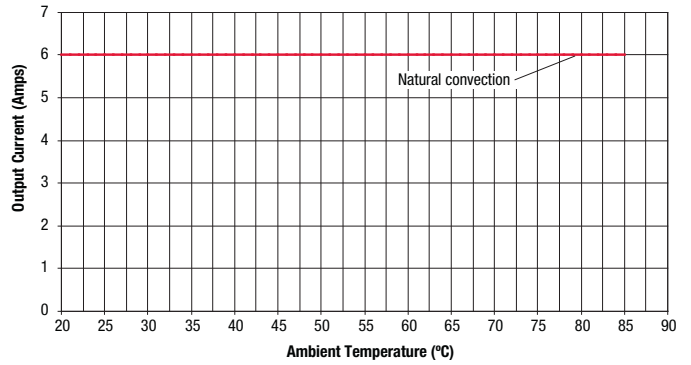

Output Ripple and Noise (V_{in}=5V, V_{out}=1.0V, I_{out}=6A, ScopeBW=20MHz)

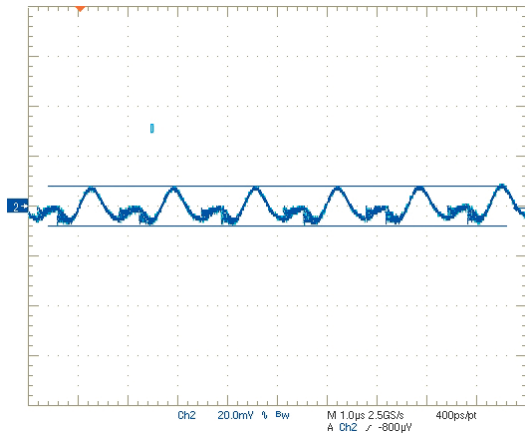

On/Off Enable Startup (V_{in}=5V, V_{out}=1.0V, I_{out}=6A, Cload=0)
Trace 4=Enable, Trace 2=V_{out}

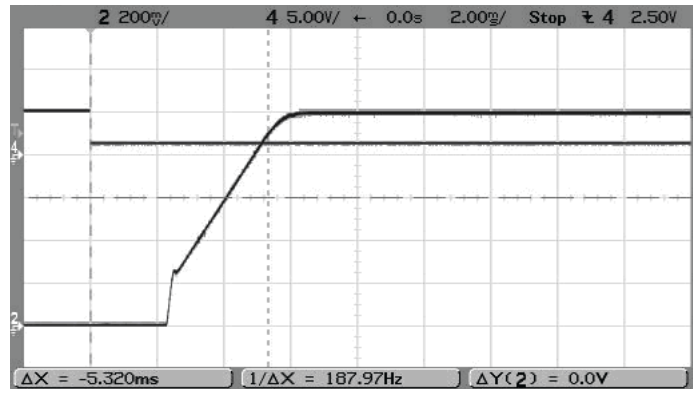

Step Load Transient Response (V_{in}=5V, V_{out}=1.0V, I_{out}=6A to 3A)
Trace 2=V_{out}, 200 mV/div. Trace 4=I_{out}, 5A/div.

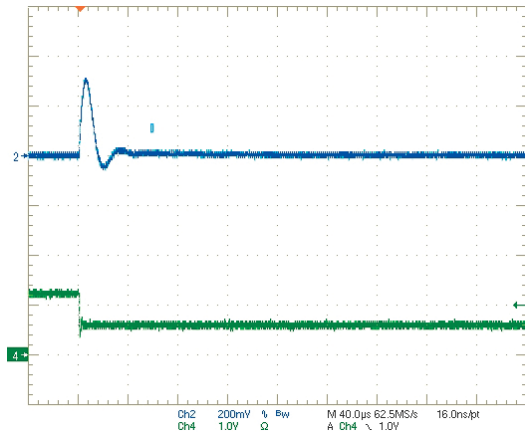

Step Load Transient Response (V_{in}=5V, V_{out}=1.0V, I_{out}=3A to 6A)
Trace 2=V_{out}, 200 mV/div. Trace 4=I_{out}, 5A/div.

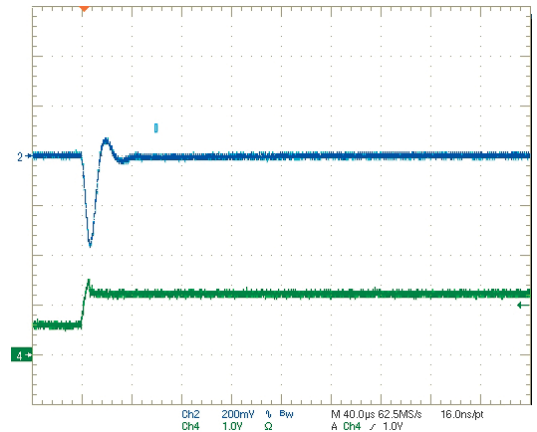

MECHANICAL SPECIFICATIONS

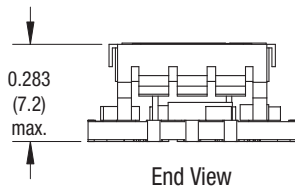
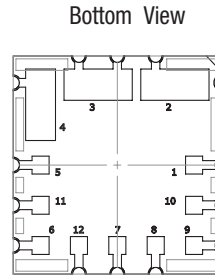
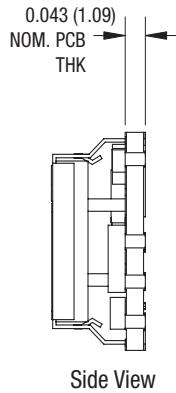
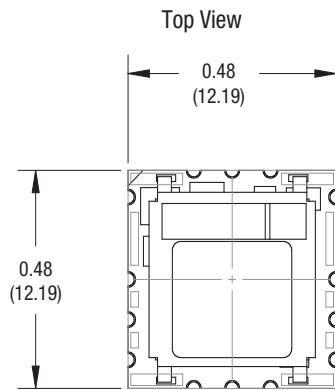

INPUT/OUTPUT CONNECTIONS	
Pin	Function
1	On/Off Control*
2	V _{IN}
3	Ground
4	V _{OUT}
5	Sense
6	Trim
7	Ground
8	No Connection
9	Sequence/Tracking**
10	No Connection
11	No Connection
12	No Connection

*The Remote On/Off can be provided with either positive (P suffix) or negative (N suffix) logic.
 **OKL2 models only

SOLDER PAD NOTES:

- [1] To avoid incorrect contacts with exposed via's and plated through holes on the bottom of the converter, do not have any exposed copper around the unit aside from our recommended footprint. Except for connections to the pads, keep all external circuits away from the board edges.
- [2] Do not connect any additional components between the Trim pin and Vout or between the Trim and Sense pins. Use only the specified connections.

Bottom View

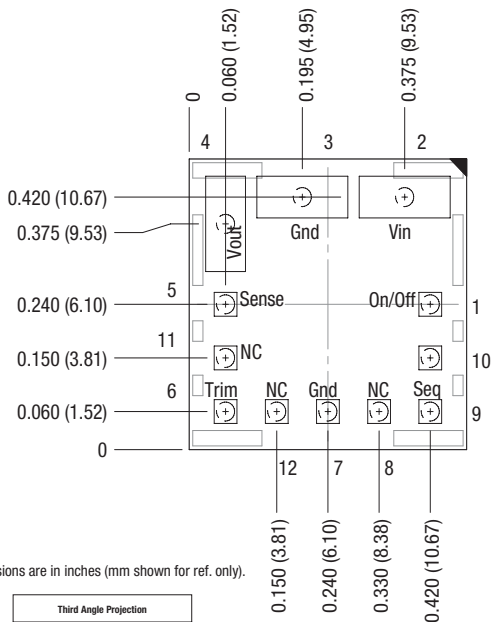

Plating Thickness:
 Gold overplate 1.18μ" (0.03μm)
 on Nickel subplate 118.1μ" (3.0μm)

Recommended Footprint -through the Board-

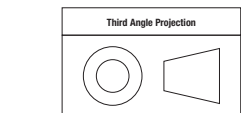
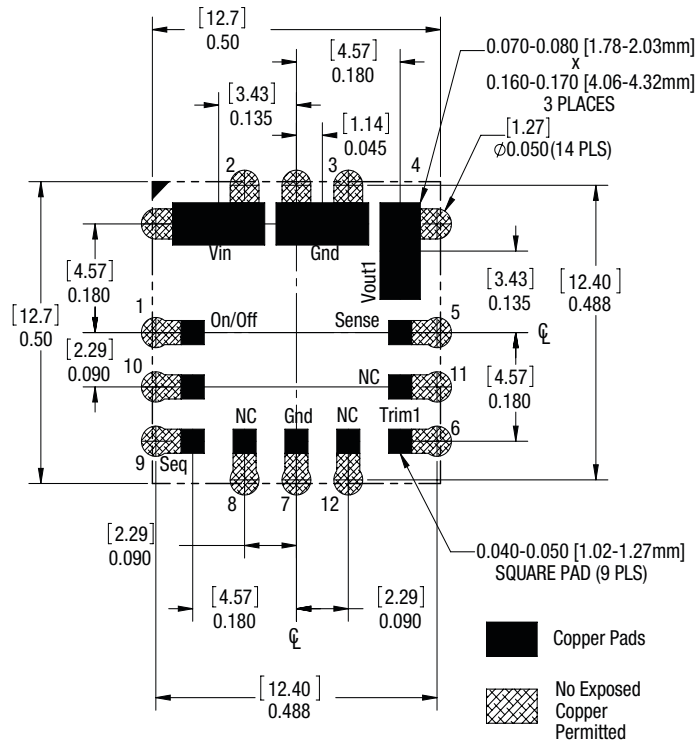

Tolerances (unless otherwise specified):
 .XX ± 0.02 (0.5)
 .XXX ± 0.010 (0.25)
 Angles ± 1°

Components are shown for reference only.

Figure 3. OKL-T/6-W5 Mechanical Outline

TAPE AND REEL INFORMATION (MSL RATING 2)

Tape Detail

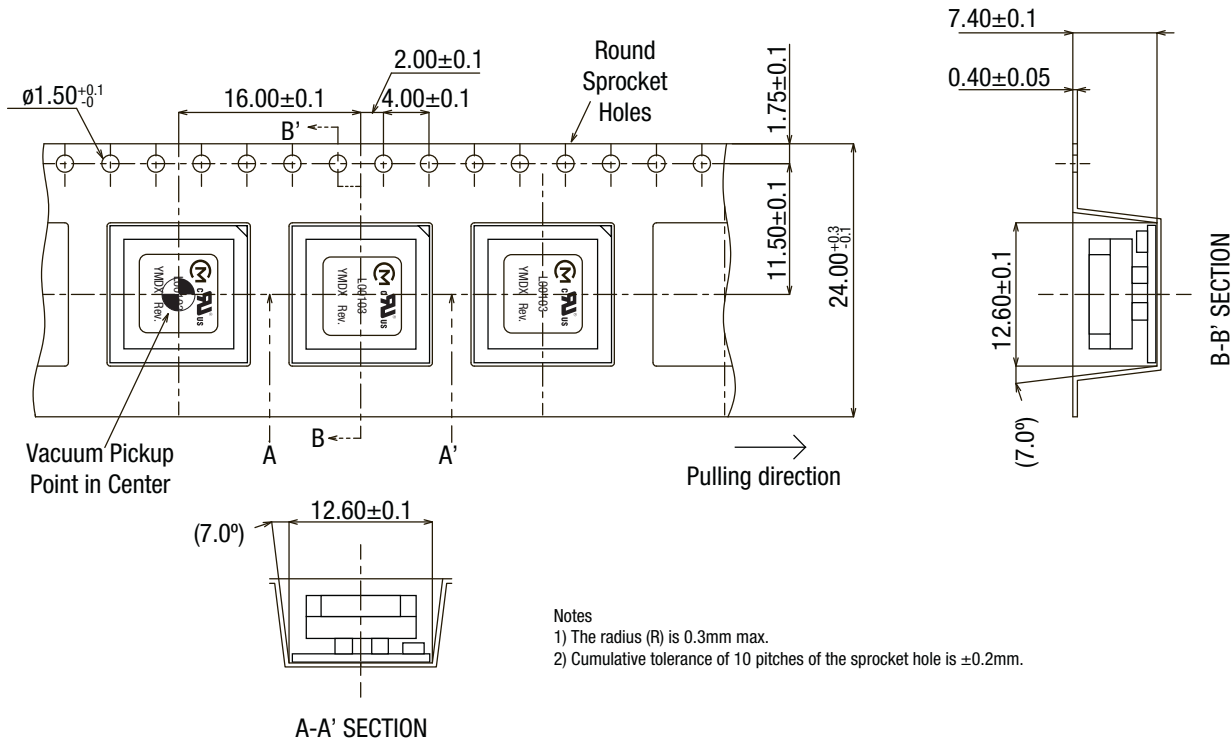

- Notes
- 1) The radius (R) is 0.3mm max.
 - 2) Cumulative tolerance of 10 pitches of the sprocket hole is ± 0.2 mm.

Reel Detail

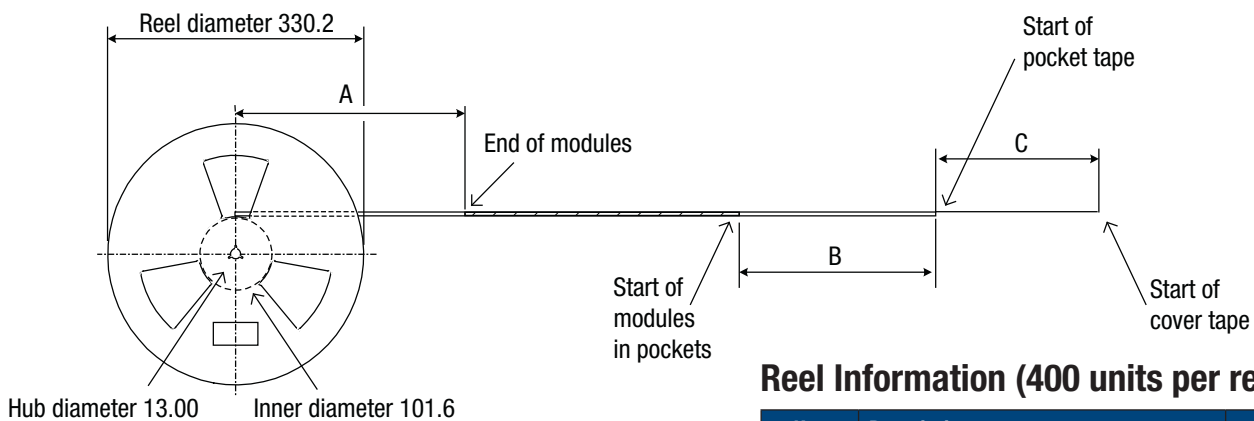

All dimensions are in millimeters.

Reel Information (400 units per reel)

Key	Description	Length (mm)
A	Tape trailer (no modules)	800 \pm 40
B	Pocket tape length before modules	200 min.
C	Cover tape length before pocket tape	240 \pm 40

TECHNICAL NOTES

Output Voltage Adjustment

The output voltage may be adjusted over a limited range by connecting an external trim resistor (Rtrim) between the Trim pin and Ground. The Rtrim resistor must be a 1/10 Watt precision metal film type, ±0.5% accuracy or better with low temperature coefficient, ±100 ppm/°C. or better. Mount the resistor close to the converter with very short leads or use a surface mount trim resistor.

In the table below, the calculated resistance is given. Do not exceed the specified limits of the output voltage or the converter's maximum power rating when applying these resistors. Also, avoid high noise at the Trim input. However, to prevent instability, you should never connect any capacitors to Trim.

Resistor Trim Equation, OKL-T/6-W5 models:

$$R_{TRIM} (K\Omega) = \frac{1.2}{V_{OUT} - 0.6}$$

Output Voltage	Calculated Rtrim (KΩ)
3.3 V.	0.444
2.5 V.	0.632
1.8 V.	1.0
1.5 V.	1.333
1.2 V.	2.0
1.0 V.	3.0
0.6 V.	∞ (open)

Do not connect any additional components between the Vtrim pin and Vout or between the Trim and Sense pins. Use only the specified connections as recommended per this data sheet.

Input Fusing

Certain applications and/or safety agencies may require fuses at the inputs of power conversion components. Fuses should also be used when there is the possibility of sustained input voltage reversal which is not current-limited. For greatest safety, we recommend a fast blow fuse installed in the ungrounded input supply line.

The installer must observe all relevant safety standards and regulations. For safety agency approvals, install the converter in compliance with the end-user safety standard.

Input Under-Voltage Shutdown and Start-Up Threshold

Under normal start-up conditions, converters will not begin to regulate properly until the rising input voltage exceeds and remains at the Start-Up Threshold Voltage (see Specifications). Once operating, converters will not turn off until the input voltage drops below the Under-Voltage Shutdown Limit. Subsequent restart will not occur until the input voltage rises again above the Start-Up Threshold. This built-in hysteresis prevents any unstable on/off operation at a single input voltage.

Users should be aware however of input sources near the Under-Voltage Shutdown whose voltage decays as input current is consumed (such as capacitor inputs), the converter shuts off and then restarts as the external capacitor recharges. Such situations could oscillate. To prevent this, make sure the operating input voltage is well above the UV Shutdown voltage AT ALL TIMES.

Start-Up Delay

Assuming that the output current is set at the rated maximum, the Vin to Vout Start-Up Delay (see Specifications) is the time interval between the point when the rising input voltage crosses the Start-Up Threshold and the fully loaded regulated output voltage enters and remains within its specified regulation band. Actual measured times will vary with input source impedance, external input capacitance, input voltage slew rate and final value of the input voltage as it appears at the converter.

These converters include a soft start circuit to moderate the duty cycle of the PWM controller at power up, thereby limiting the input inrush current.

The On/Off Remote Control interval from inception to Vout regulated assumes that the converter already has its input voltage stabilized above the Start-Up Threshold before the On command. The interval is measured from the On command until the output enters and remains within its specified accuracy band. The specification assumes that the output is fully loaded at maximum rated current.

Recommended Input Filtering

The user must assure that the input source has low AC impedance to provide dynamic stability and that the input supply has little or no inductive content, including long distributed wiring to a remote power supply. The converter will operate with no additional external capacitance if these conditions are met.

For best performance, we recommend installing a low-ESR capacitor immediately adjacent to the converter's input terminals. The capacitor should be a ceramic type such as the Murata GRM32 series or a polymer type. Initial suggested capacitor values are 10 to 22 µF, rated at twice the expected maximum input voltage. Make sure that the input terminals do not go below the undervoltage shutdown voltage at all times. More input bulk capacitance may be added in parallel (either electrolytic or tantalum) if needed.

Recommended Output Filtering

The converter will achieve its rated output ripple and noise with no additional external capacitor. However, the user may install more external output capacitance to reduce the ripple even further or for improved dynamic response. Again, use low-ESR ceramic (Murata GRM32 series) or polymer capacitors. Initial values of 10 to 47 µF may be tried, either single or multiple capacitors in parallel. Mount these close to the converter. Measure the output ripple under your load conditions.

Use only as much capacitance as required to achieve your ripple and noise objectives. Excessive capacitance can make step load recovery sluggish or possibly introduce instability. Do not exceed the maximum rated output capacitance listed in the specifications.

Input Ripple Current and Output Noise

All models in this converter series are tested and specified for input reflected ripple current and output noise using designated external input/output components, circuits and layout as shown in the figures below. The Cbus and Lbus components simulate a typical DC voltage bus. Please note that the values of Cin, Lbus and Cbus will vary according to the specific converter model.

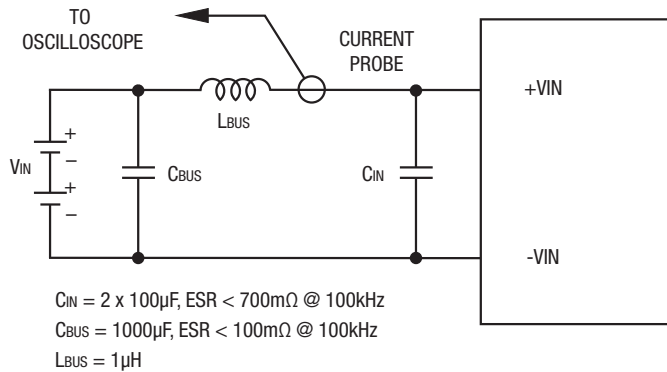

Figure 4. Measuring Input Ripple Current

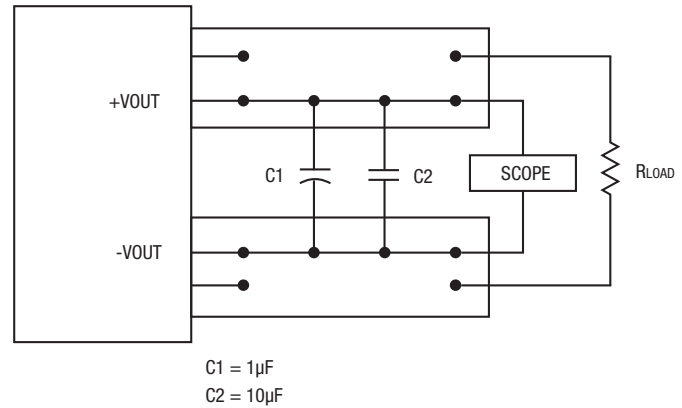

Figure 5. Measuring Output Ripple and Noise (PARD)

Minimum Output Loading Requirements

All models regulate within specification and are stable under no load to full load conditions. Operation under no load might however slightly increase output ripple and noise.

Thermal Shutdown

To prevent many over temperature problems and damage, these converters include thermal shutdown circuitry. If environmental conditions cause the temperature of the DC/DC's to rise above the Operating Temperature Range up to the shutdown temperature, an on-board electronic temperature sensor will power down the unit. When the temperature decreases below the turn-on threshold, the converter will automatically restart. There is a small amount of hysteresis to prevent rapid on/off cycling.

CAUTION: If you operate too close to the thermal limits, the converter may shut down suddenly without warning. Be sure to thoroughly test your application to avoid unplanned thermal shutdown.

Temperature Derating Curves

The graphs in this data sheet illustrate typical operation under a variety of conditions. The Derating curves show the maximum continuous ambient air temperature and decreasing maximum output current which is acceptable under increasing forced airflow measured in Linear Feet per Minute ("LFM"). Note that these are AVERAGE measurements. The converter will accept brief increases in current or reduced airflow as long as the average is not exceeded.

Note that the temperatures are of the ambient airflow, not the converter itself which is obviously running at higher temperature than the outside air. Also note that very low flow rates (below about 25 LFM) are similar to "natural convection", that is, not using fan-forced airflow.

Murata Power Solutions makes Characterization measurements in a closed cycle wind tunnel with calibrated airflow. We use both thermocouples and an infrared camera system to observe thermal performance.

CAUTION: These graphs are all collected at slightly above Sea Level altitude. Be sure to reduce the derating for higher density altitude.

Output Voltage Sequencing

The OKL modules include a sequencing feature that enables users to implement various types of output voltage sequencing in their applications. This is accomplished via an additional sequencing pin. When not using the sequencing feature, either tie the sequence pin to Vin or leave it unconnected.

When an analog voltage is applied to the sequence pin, the output voltage tracks this voltage until the output reaches the set-point voltage. The final value of the sequence voltage must be set higher than the set-point voltage of the module. The output voltage follows the voltage on the sequence pin on a one-to-one volt basis. By connecting multiple modules together, multiple modules can track their output voltages to the voltage applied on the sequence pin.

For proper voltage sequencing, first, input voltage is applied to the module. The On/Off pin of the module is left unconnected (or tied to GND for negative logic modules or tied to Vin for positive logic modules) so that the module is ON by default. After applying input voltage to the module, a minimum 10msec delay is required before applying voltage on the sequence pin. During this time, a voltage of 50mV (± 20 mV) is maintained on the sequence pin. This delay gives the module enough time to complete its internal powerup soft-start cycle. During the delay time, the sequence pin should be held close to ground (nominally 50mV ± 20 mV). This is required to keep the internal opamp out of saturation thus preventing output overshoot during the start of the sequencing ramp. By selecting resistor R1 according to the following equation

$$R1 = \frac{23500}{V_{in} - 0.05} \text{ ohms,}$$

the voltage at the sequencing pin will be 50mV when the sequencing signal is at zero. See figure 6 for R1 connection for the sequencing signal to the SEQ pin.

[Click here to view Application Note DCAN-61](#)

Output Current Limiting

Current limiting inception is defined as the point at which full power falls below the rated tolerance. See the Performance/Functional Specifications. Note particularly that the output current may briefly rise above its rated value in normal operation as long as the average output power is not exceeded. This enhances reliability and continued operation of your application. If the output current is too high, the converter will enter the short circuit condition.

Output Short Circuit Condition

When a converter is in current-limit mode, the output voltage will drop as the output current demand increases. If the output voltage drops too low (approximately 98% of nominal output voltage for most models), the magnetically coupled voltage used to develop PWM bias voltage will also drop, thereby shutting down the PWM controller. Following a time-out period, the PWM will restart, causing the output voltage to begin rising to its appropriate value. If the short-circuit condition persists, another shutdown cycle will initiate. This rapid on/off cycling is called “hiccup mode”. The hiccup cycling reduces the average output current, thereby preventing excessive internal temperatures and/or component damage.

The “hiccup” system differs from older latching short circuit systems because you do not have to power down the converter to make it restart. The system will automatically restore operation as soon as the short circuit condition is removed.

Remote On/Off Control

The OKL Series power modules can be specified with either a positive or negative logic type. See Figures 7 and 8 for On/Off circuit control. In the positive logic on/off option the unit turns on during a logic high on the On/Off pin and turns off during a logic low. In a negative logic on/off option, the unit turns off during logic high and on during logic low. The On/Off signal should always be reference to ground. For positive or negative option, leaving then On/Off pin disconnected will turn the unit on when input voltage is present.

Positive—Units are enabled when the on/off pin is left open or is pulled high to +Vin. The On/Off circuit control is shown in figure 7. When the external transistor Q1 is in the off state, the internal PWM enable pin is pull high causing the unit to turn on. When Q1 is turn on, the On/Off pin is pulled low and the units is off. Rp should be around 20K ohms.

Negative—Units are enabled when the ON/Off is open or brought to within a low voltage (see specifications) with respect to -Vin. The unit is off when the ON/Off is pulled high with respect to -Vin (see specifications). The On/Off circuitry is shown in figure 8. The On/Off pin should be pulled high with an external pull-up resistor (20K ohms). When Q1 is in the off state, the On/Off pin is pulled high, transistor Q3 is turn on and the unit is off. To turn on the unit, Q1 is turn on, pulling the On/Off pin low and turning Q3 off resulting on the unit being on.

Dynamic control of the On/Off function should be able to sink the specified signal current when brought low and withstand appropriate voltage when brought high. Be aware too that there is a finite time in milliseconds (see specifications) between the time of On/Off Control activation and stable, regulated output. This time will vary slightly with output load type and current and input conditions.

Output Capacitive Load

These converters do not require external capacitance added to achieve rated specifications. Users should only consider adding capacitance to reduce switching noise and/or to handle spike current load steps. Install only enough capacitance to achieve noise objectives. Excess external capacitance may cause regulation problems, degraded transient response and possible oscillation or instability.

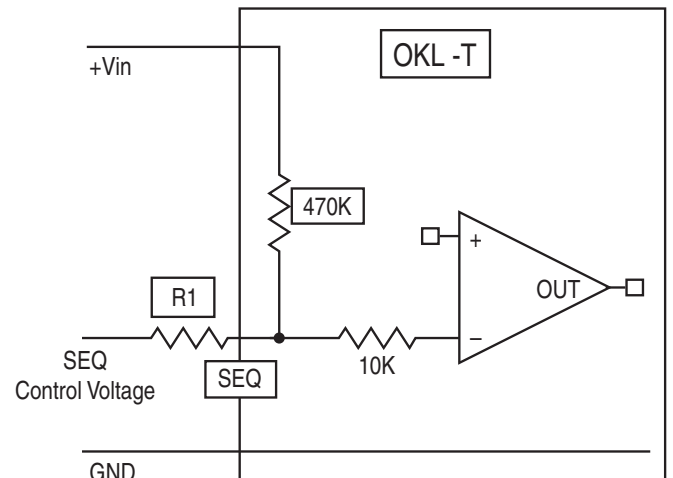

Figure 6. Sequencing Signal Interface of Module

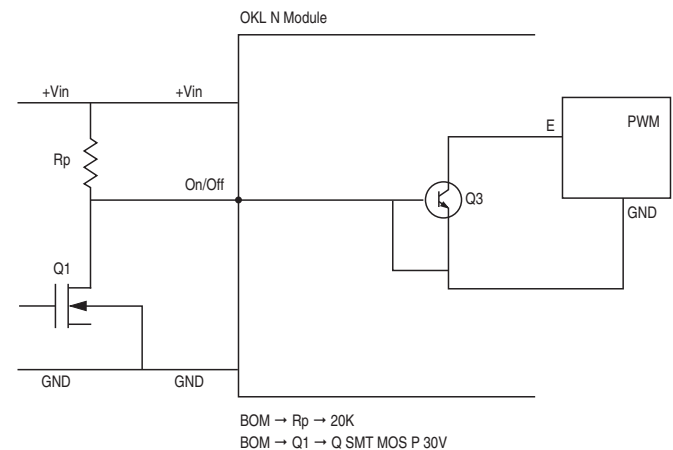
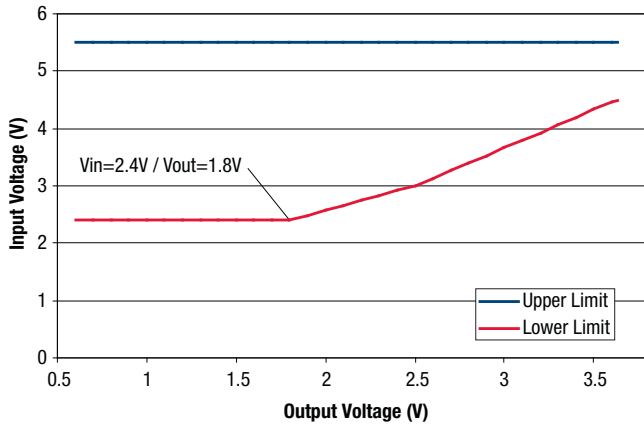

Figure 7. On/Off Circuit Control for Using Negative On/Off Logic

Voltage Range Graph

Please observe the limits below for voltage input and output ranges. These limits apply at all output currents.



Soldering Guidelines

Murata Power Solutions recommends the specifications below when installing these converters. These specifications vary depending on the solder type. Exceeding these specifications may cause damage to the product. Your production environment may differ therefore please thoroughly review these guidelines with your process engineers.

Reflow Solder Operations for surface-mount products (SMT)

For Sn/Ag/Cu based solders:	
Preheat Temperature	Less than 1 °C. per second
Time over Liquidus	45 to 75 seconds
Maximum Peak Temperature	260 °C.
Cooling Rate	Less than 3 °C. per second
For Sn/Pb based solders:	
Preheat Temperature	Less than 1 °C. per second
Time over Liquidus	60 to 75 seconds
Maximum Peak Temperature	235 °C.
Cooling Rate	Less than 3 °C. per second

Recommended Lead-free Solder Reflow Profile

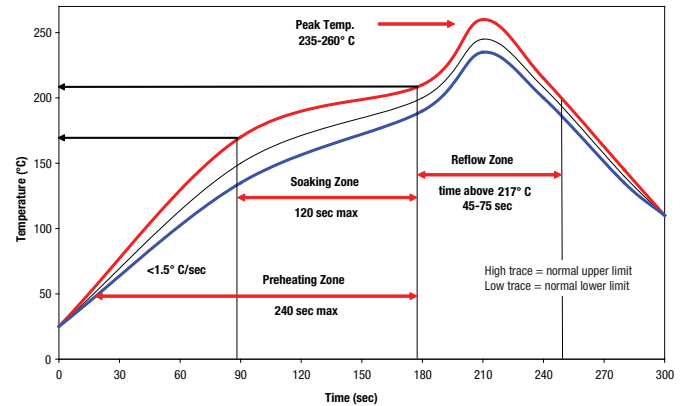

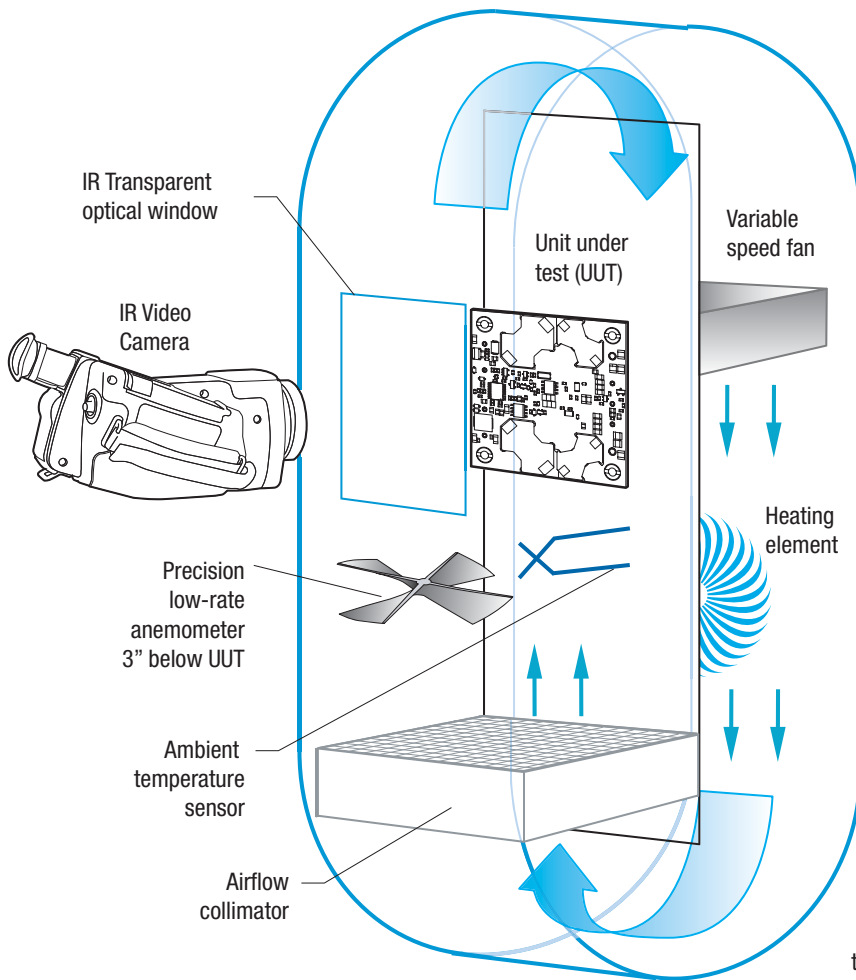

Figure 8. Vertical Wind Tunnel

Vertical Wind Tunnel

Murata Power Solutions employs a computer controlled custom-designed closed loop vertical wind tunnel, infrared video camera system, and test instrumentation for accurate airflow and heat dissipation analysis of power products. The system includes a precision low flow-rate anemometer, variable speed fan, power supply input and load controls, temperature gauges, and adjustable heating element.

The IR camera monitors the thermal performance of the Unit Under Test (UUT) under static steady-state conditions. A special optical port is used which is transparent to infrared wavelengths.

Both through-hole and surface mount converters are soldered down to a host carrier board for realistic heat absorption and spreading. Both longitudinal and transverse airflow studies are possible by rotation of this carrier board since there are often significant differences in the heat dissipation in the two airflow directions. The combination of adjustable airflow, adjustable ambient heat, and adjustable Input/Output currents and voltages mean that a very wide range of measurement conditions can be studied.

The collimator reduces the amount of turbulence adjacent to the UUT by minimizing airflow turbulence. Such turbulence influences the effective heat transfer characteristics and gives false readings. Excess turbulence removes more heat from some surfaces and less heat from others, possibly causing uneven overheating.

Both sides of the UUT are studied since there are different thermal gradients on each side. The adjustable heating element and fan, built-in temperature gauges, and no-contact IR camera mean that power supplies are tested in real-world conditions.

