



## Features

- Surface Mount Device
- Reduced footprint size
- High voltage surge capabilities
- Assists in meeting ITU K.20/K.21/K.45 specifications
- RoHS compliant\*
- Agency recognition: 

## Applications

- Provides overcurrent protection in:
- Customer Premise Equipment (CPE)
  - Central Office (CO)
  - Access/Outside Plant Equipment

# MF-SM013/250V - Telecom PTC Resettable Fuses

### Electrical Characteristics

Model	Max. Operating Voltage Volts	Max. Interrupt Ratings		Hold Current Amps at 23 °C	Initial Resistance		One Hour Post-Trip Resistance Ohms at 23 °C	Tripped Power Dissipation Watts at 23 °C
		Volts (V)	Amps (A)		Ohms at 23 °C	Ohms at 23 °C		
		Max.	Max.	I <sub>H</sub>	Min.	Max.	Max.	Typ.
MF-SM013/250V	60	250	3.0	0.13	4.0	7.0	16.0	3.0

### Environmental Characteristics

Operating Temperature.....	-40 °C to +85 °C
Maximum Device Surface Temperature in Tripped State .....	125 °C
Passive Aging .....	+85 °C, 1000 hours..... ±15 % typical resistance change
Humidity Aging.....	+85 °C, 85 % R.H. 1000 hours ..... ±15 % typical resistance change
Thermal Shock .....	MIL-STD-202F, Method 107G,..... ±15 % typical resistance change +125 °C to -55 °C, 10 times..... ±15 % typical resistance change
Solvent Resistance.....	MIL-STD-202, Method 215B..... No change
Lead Solderability.....	ANSI/J-STD-002
Vibration .....	MIL-STD-883C, Method 2007.1, Condition A ..... No change
Moisture Sensitivity Level (MSL).....	Level 1
ESD Classification - HBM.....	Class 6

### Test Procedures And Requirements For Model MF-SM013/250V Series

Test	Test Conditions	Accept/Reject Criteria
Visual/Mech.....	Verify dimensions and materials.....	Per MF physical description
Resistance.....	In still air @ 23 °C.....	R <sub>min</sub> ≤ R ≤ R <sub>max</sub>
Time to Trip.....	At specified current, V <sub>max</sub> , 23 °C.....	T ≤ max. time to trip (seconds)
Hold Current .....	30 min. at I <sub>hold</sub> .....	No trip
Trip Cycle Life.....	V <sub>max</sub> , I <sub>max</sub> , 100 cycles.....	No arcing or burning
Trip Endurance .....	V <sub>max</sub> , 48 hours.....	No arcing or burning
Solderability .....	MIL-STD-202F, Method 208F.....	95 % min. coverage

UL File Number ..... E174545

TÜV File Number..... R2057213

### Thermal Derating Chart - I<sub>hold</sub>/I<sub>trip</sub> (Amps)

Model	Ambient Operating Temperature								
	-40 °C	-20 °C	0 °C	23 °C	40 °C	50 °C	60 °C	70 °C	85 °C
MF-SM013/250V	0.21 / 0.42	0.18 / 0.37	0.16 / 0.31	0.13 / 0.26	0.10 / 0.23	0.09 / 0.18	0.08 / 0.15	0.07 / 0.12	0.05 / 0.10

\*RoHS Directive 2002/95/EC Jan. 27, 2003 including annex and RoHS Recast 2011/65/EU June 8, 2011.

Specifications are subject to change without notice.

The device characteristics and parameters in this data sheet can and do vary in different applications and actual device performance may vary over time.

Users should verify actual device performance in their specific applications.

# MF-SM013/250V - Telecom PTC Resettable Fuses

**BOURNS®**

## Product Dimensions

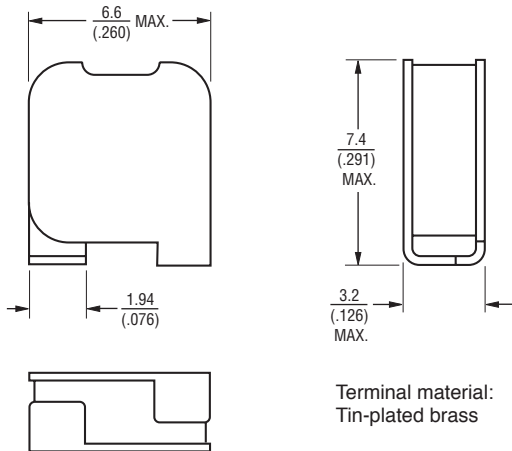

## Recommended Pad Layout

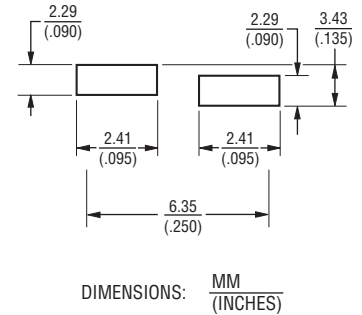

Packaging:  
TAPE & REEL: 1000 pcs. per reel

## Solder Reflow Recommendations

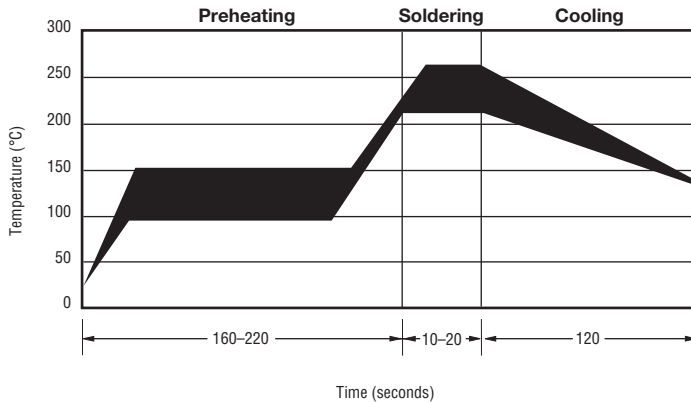

### Solder reflow

- Recommended reflow methods: IR, vapor phase oven, hot air oven.
- Devices are not designed to be wave soldered to the bottom side of the board.
- Gluing the devices is not recommended.
- Recommended maximum paste thickness is 0.25 mm (.010 inch).
- Devices can be cleaned using standard industry methods and solvents.

### Note:

- If reflow temperatures exceed the recommended profile, devices may not meet the performance requirements.

### Rework

- A device should not be reworked.

## Storage Recommendations

The recommended long term storage conditions for Multifuse® Polymer PTC devices are 40 °C maximum and 70 % RH maximum. All devices should remain in the original sealed packaging prior to use. Devices may not conform with data sheet specifications if these storage recommendations are exceeded. Devices stored in this manner have an indefinite shelf life.

# MF-SM013/250V - Telecom PTC Resettable Fuses



## Typical Time to Trip at 23 °C

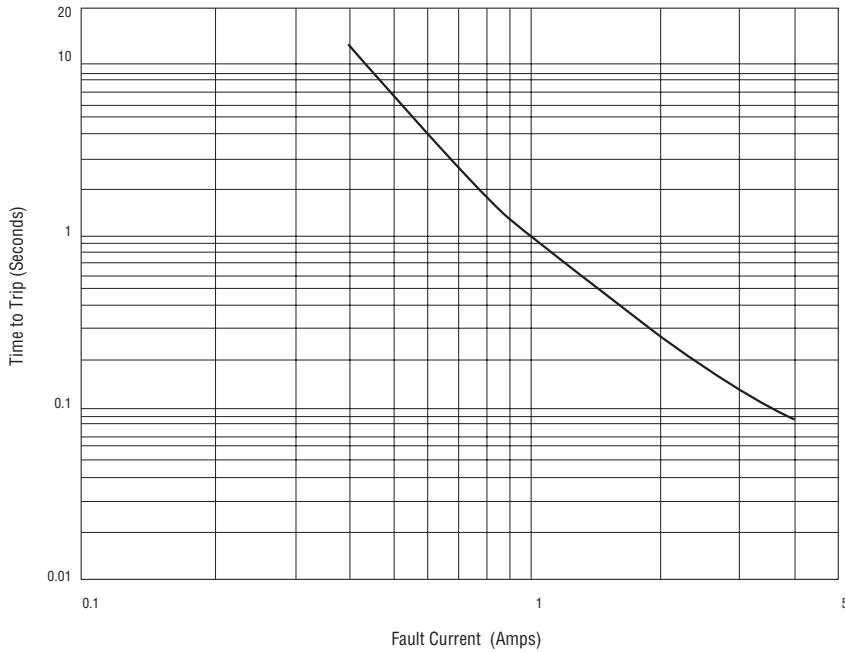

## Typical Part Marking

Represents total content. Layout may vary.

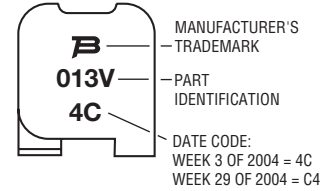

## How to Order

**MF - SM 013/250V - 2**

Multifuse®  
 Product Designator

Series — SM = Surface Mount Component

Hold Current, I<sub>hold</sub> — 013 = 0.13 Amps

Max. Interrupt Voltage, V — 250 = 250 Volts

Telecom Options — V = Vertical Profile (Surface Mount Products Only)

Packaging Options — 0 = Bulk Packaging  
 - 2 = Tape and Reel\*

\*Packaged per EIA486-B

MF-SM, MF-SM/33, MF-SM/60 & MF-SM/250 Series Tape and Reel Specifications



NOTE: Effective December 1, 2010 (product date code V0), the cover tape was changed to the new 3M™ Universal Cover Tape (UCT).

Tape Dimensions	MF-SM030, 050, 075, 100, 125, 260, 300; MF-SM075/60; MF-SM-100/33; MF-SM008/250 per EIA-481-2	MF-SM150, 200, 250; MF-SM-150/33, MF-SM-185/33; MF-SM013/250 per EIA 481-2
	W max.	16.3 (0.642)
P <sub>0</sub>	4.0 ± 0.1 (0.157 ± 0.004)	4.0 ± 0.1 (0.157 ± 0.004)
P <sub>1</sub>	8.0 ± 0.1 (0.315 ± 0.004)	12.0 ± 0.1 (0.472 ± 0.004)
P <sub>2</sub>	2.0 ± 0.1 (0.079 ± 0.004)	2.0 ± 0.1 (0.079 ± 0.004)
A <sub>0</sub>	5.7 ± 0.1 (0.224 ± 0.004)	6.9 ± 0.1 (0.272 ± 0.004)
B <sub>0</sub>	8.1 ± 0.1 (0.319 ± 0.004)	9.6 ± 0.1 (0.378 ± 0.004)
B <sub>1</sub> max.	12.1 (0.476)	12.1 (0.476)
D <sub>0</sub>	1.5 + 0.1/-0.0 (0.059 + 0.004/-0)	1.5 + 0.1/-0.0 (0.059 + 0.004/-0)
F	7.5 ± 0.1 (0.295 ± 0.004)	7.5 ± 0.1 (0.295 ± 0.004)
E <sub>1</sub>	1.75 ± 0.1 (0.069 ± 0.004)	1.75 ± 0.1 (0.069 ± 0.004)
E <sub>2</sub> min.	14.25 (0.561)	14.25 (0.561)
T max.	0.6 (0.024)	0.6 (0.024)
T <sub>1</sub> max.	0.1 (0.004)	0.1 (0.004)
K <sub>0</sub>	3.4 ± 0.1 (0.134 ± 0.004)	3.4 ± 0.1* (0.134 ± 0.004)*
Leader min.	390 (15.35)	390 (15.35)
Trailer min.	160 (6.30)	160 (6.30)
<b>Reel Dimensions</b>		
A max.	360 (14.17)	360 (14.17)
N min.	50 (1.97)	50 (1.97)
W <sub>1</sub>	16.4 + 2.0/-0.0 (0.646 + 0.079/-0)	16.4 + 2.0/-0.0 (0.646 + 0.079/-0)
W <sub>2</sub> max.	22.4 (0.882)	22.4 (0.882)

\* Model MF-SM013/250 =  $\frac{3.8 \pm 0.1}{(0.150 \pm 0.004)}$

DIMENSIONS:  $\frac{\text{MM}}{\text{(INCHES)}}$

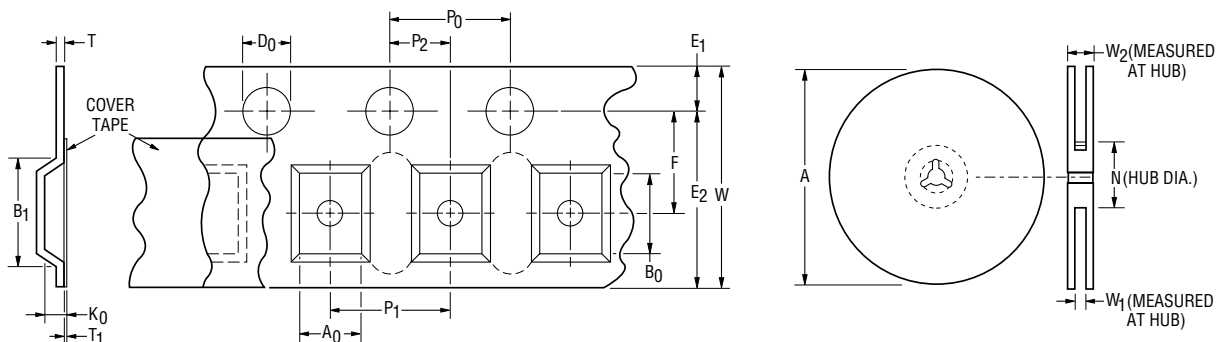

Specifications are subject to change without notice.  
The device characteristics and parameters in this data sheet can and do vary in different applications and actual device performance may vary over time.  
Users should verify actual device performance in their specific applications.