

Features

- 802.11a + b/g and MIMO Applications
- Test and Measurement and Low/Medium Power Telecommunication Applications up to 8.0 GHz
- Broadband Performance: DC - 8.0 GHz
- Low Insertion Loss: 0.5 dB from 2.0 - 6.0 GHz
- High Isolation: 30 dB from 2.0 - 6.0 GHz
- Fast Settling for Low Gate Lag Requirements
- Lead-Free 2 mm 8-Lead PDFN Package
- 100% Matte Tin Plating over Copper
- Halogen-Free “Green” Mold Compound
- RoHS Compliant* and 260°C Reflow Compatible

Description

The MASW-007107 is a broadband GaAs pHEMT MMIC SPDT switch in a lead-free 2 mm 8-lead PDFN package. Typical applications are for WLAN IEEE 802.11a + b/g, and MIMO. Other applications include test equipment requiring ultra fast switching speeds. Designed for low insertion loss, this SPDT switch maintains low loss up to 8.0 GHz.

The MASW-007107 is fabricated using a 0.5 micron gate length GaAs pHEMT process. The process features full passivation for performance and reliability.

Ordering Information^{1,2}

Part Number	Package
MASW-007107-TR3000	3000 piece reel
MASW-007107-000SMB	Sample Test Board
MASW-007107-000DIE ³	Separated die on grip ring
MASW-007107-0GPDIE	100 piece gel pack

1. Reference Application Note M513 for reel size information.
2. All sample boards include 5 loose parts.
3. Die quantity varies.

Functional Schematic

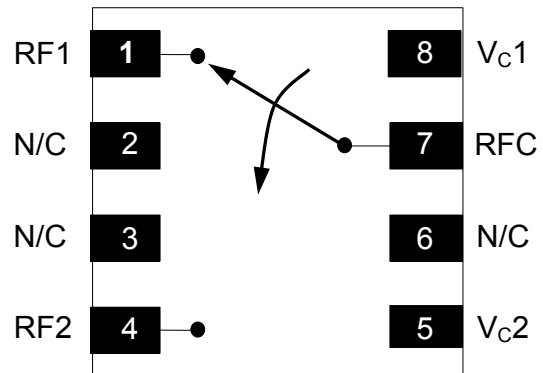

Pin Configuration⁴

Pin No.	Pin Name	Description
1	RF1	RF Output 1
2	N/C	No Connection
3	N/C	No Connection
4	RF2	RF Output 2
5	Vc2	Voltage Control 2
6	N/C	No Connection
7	RFC	RF Common
8	Vc1	Voltage Control 1
9	Paddle ⁵	RF and DC Ground

4. MACOM recommends connecting unused package pins to ground.
5. The exposed pad centered on the package bottom must be connected to RF, DC and thermal ground.

* Restrictions on Hazardous Substances, European Union Directive 2011/65/EU.

GaAs Broadband SPDT Switch DC - 8.0 GHz

Rev. V7

Electrical Specifications: $T_A = +25^\circ\text{C}$, $V_C = 0\text{ V} / 3\text{ V}$, $Z_0 = 50\ \Omega$, 8 pF Capacitor^{6,7}

Parameter	Test Conditions	Units	Min.	Typ.	Max.
Insertion Loss ⁸	2.0 - 6.0 GHz	dB	—	0.50	0.8
	6.0 - 8.0 GHz			0.75	
Isolation	2.4 GHz	dB	24	29	—
	5.3 GHz			33	
	5.8 GHz			30	
	6.0 - 8.0 GHz			20	
Return Loss	DC - 8.0 GHz	dB	—	16	—
Input IP2	Two Tone, 5 dBm / Tone, 5 MHz Spacing	dBm	—	92	—
	2.4 GHz			83	
	5.3 GHz			85	
Input IP3	Two Tone, 5 dBm / Tone, 10 MHz Spacing	dBm	—	54	—
	2.4 GHz (3 V)			49	
	5.8 GHz (3 V)			—	
	2.4 GHz (5 V)	55	—		
	5.8 GHz (5 V)	51			
	Two Tone, 15 dBm / Tone, 10 MHz Spacing	dBm		—	57
2.4 GHz (3 V)	54				
5.8 GHz (3 V)	—				
2.4 GHz (5 V)	59	—			
5.8 GHz (5 V)	58				
Input P0.1dB	2.4 GHz	dBm	—	26	—
	5.3 GHz			26	
	5.8 GHz			25	
Input P1dB	2.4 GHz	dBm	—	30.5	—
	5.3 GHz			29.5	
	5.8 GHz			27.0	
Linear Pout	2.4 GHz, OFDM, QAM-64, 54 Mbps, EVM = 2.5%	dBm	—	21.0	—
	3 V			27.5	
	5 V			30.0	
	8 V			—	
2nd Harmonic	2.4 GHz, $P_{IN} = 20\text{ dBm}$	dBc	—	-80	—
	5.3 GHz, $P_{IN} = 20\text{ dBm}$			-71	
	5.8 GHz, $P_{IN} = 20\text{ dBm}$			-71	
3rd Harmonic	2.4 GHz, $P_{IN} = 20\text{ dBm}$	dBc	—	-83	—
	5.3 GHz, $P_{IN} = 20\text{ dBm}$			-71	
	5.8 GHz, $P_{IN} = 20\text{ dBm}$			-72	
T_{RISE}, T_{FALL}	10% to 90% RF and 90% to 10% RF	ns	—	13	—
T_{ON}, T_{OFF}	50% control to 90% RF and 50% control to 10% RF	ns	—	35	—
Transients	—	mV	—	14	—
Control Current	$ V_C = 3\text{ V}$	μA	—	1	5
RON	$t > 90\text{ ms}$ after OFF to ON Switching (settled)	Ω	—	2.50	—
Gate Lag	$ \Delta R_{on} $ between 15 μs and 90 ms after OFF to ON Switching	Ω	—	0.15	—

6. For positive voltage control, external DC blocking capacitors are required on all RF ports.

7. Electrical minimum and maximum specifications are guaranteed in final package assembly only.

8. Insertion loss can be optimized by varying the DC blocking capacitor value.

Absolute Maximum Ratings^{9,10}

Parameter	Absolute Maximum
Input Power @ 3 V Control	32 dBm
Input Power @ 5 V Control	34 dBm
Operating Voltage	8.5 volts
Operating Temperature	-40°C to +85°C
Storage Temperature	-65°C to +150°C

9. Exceeding any one or combination of these limits may cause permanent damage to this device.
 10. MACOM does not recommend sustained operation near these survivability limits.

Application Schematic

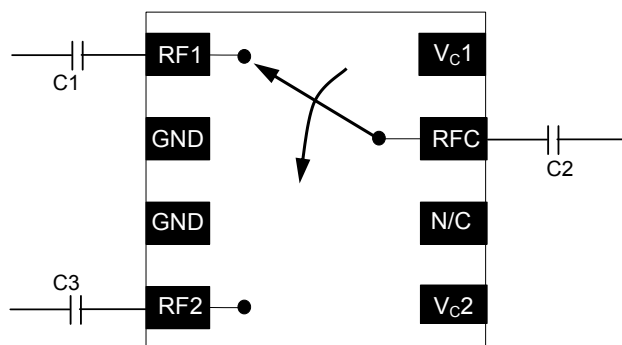

C1, C2, C3 = 8 pF

Truth Table¹¹

Control V _{C1}	Control V _{C2}	RFC—RF1	RFC—RF2
1	0	On	Off
0	1	Off	On

11. 1 = +2.9 V to +5 V, 0 = 0 V ± 0.2 V.

Qualification

Qualified to MACOM specification REL-201, Process Flow -2.

Handling Procedures

Please observe the following precautions to avoid damage:

Static Sensitivity

These electronic devices are sensitive to electrostatic discharge (ESD) and can be damaged by static electricity. Proper ESD control techniques should be used when handling these devices.

Typical Performance Curves

Return Loss vs. Frequency

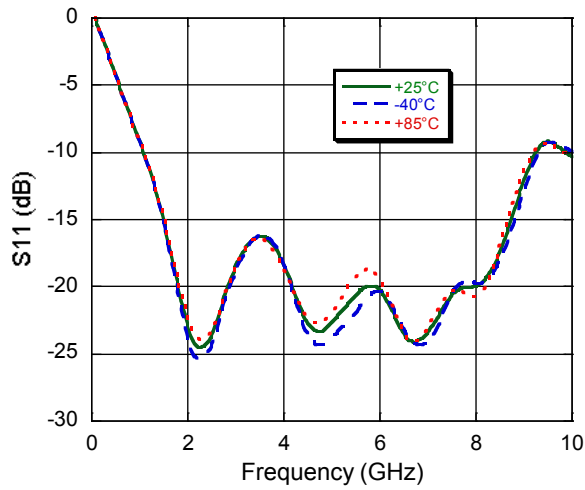

Isolation vs. Frequency

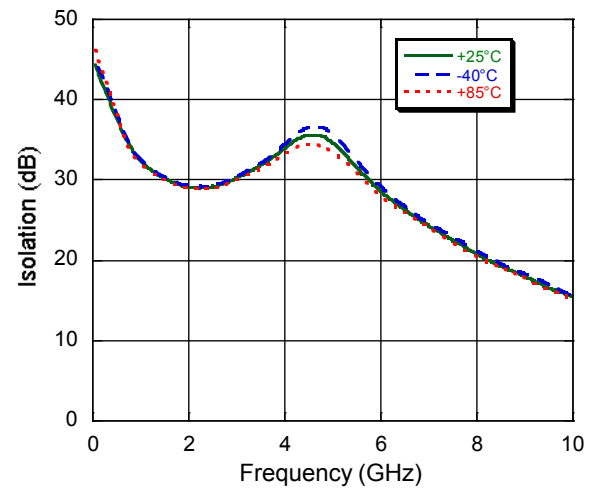

Insertion Loss vs. Frequency

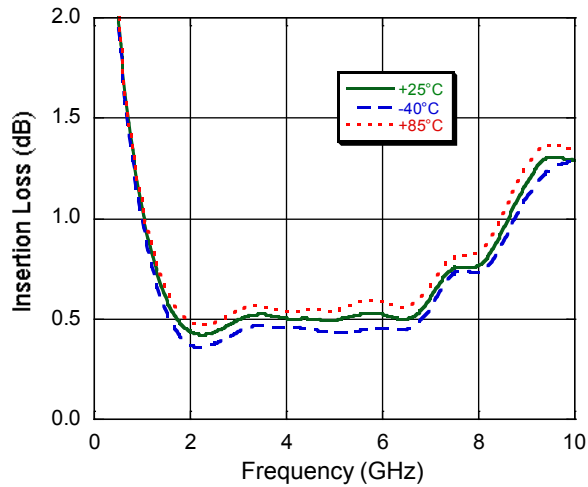

EVM vs. Pout @ 2.4 GHz

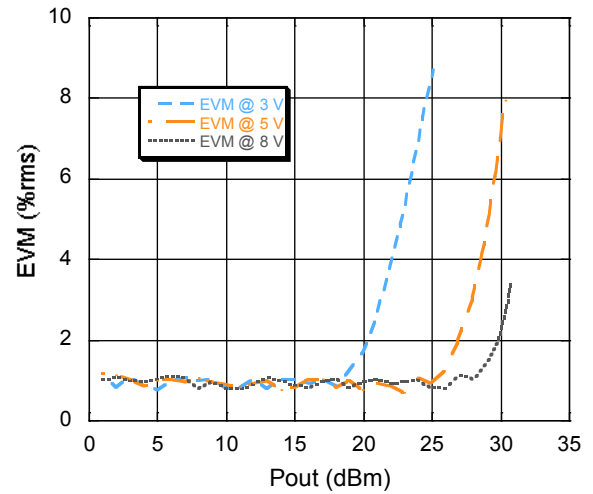

GaAs Broadband SPDT Switch DC - 8.0 GHz

Rev. V7

Die Outline Drawing^{12,13,14,15}

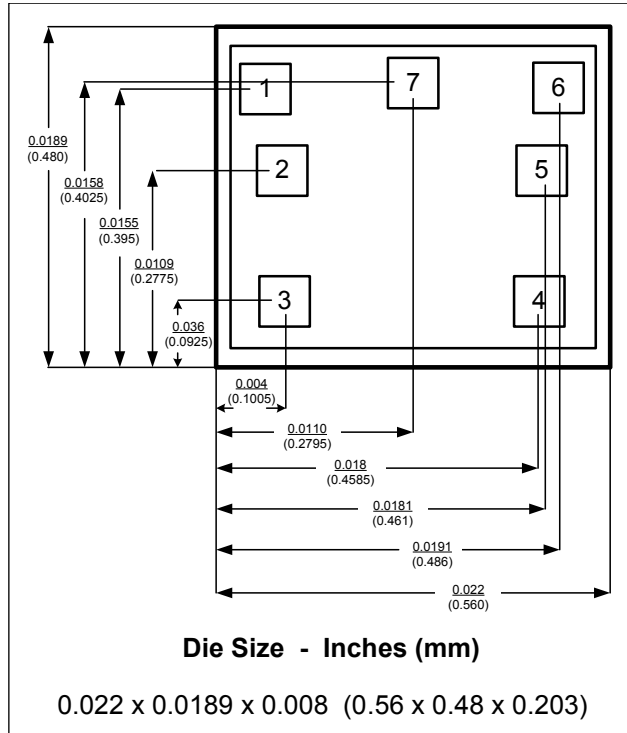

- 12. Typical dimensions in inches (millimeters)
- 13. Die thickness is 0.008" (0.203 mm)
- 14. Typical bond pad is 0.003" square (0.076 mm square)
- 15. Bond pad metallization is gold.

Die Bond Pad Configuration

Pad No.	Name	Description
1	V _{C1}	Voltage Control 1
2	RF1	RF Output 1
3	GND	Ground
4	GND	Ground
5	RF2	RF Output 2
6	V _{C2}	Voltage Control 2
7	RFC	RF Common

Lead Free 2 mm 8-lead PDFN †

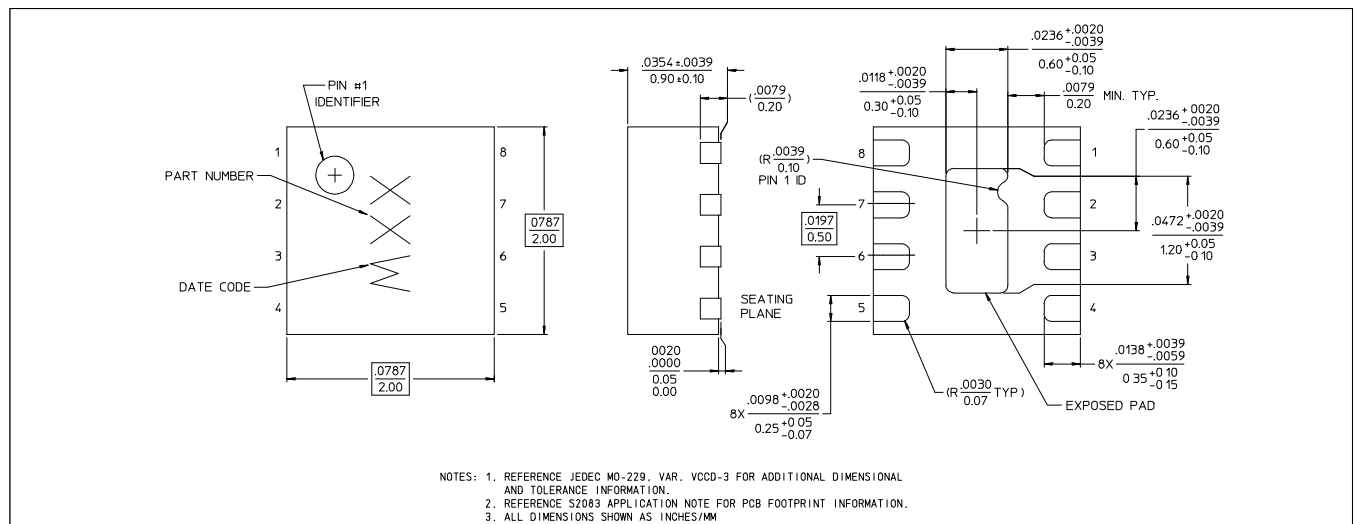

† Reference Application Note S2083 for lead-free solder reflow recommendations.
Meets JEDEC moisture sensitivity level 1 requirements.

MACOM Technology Solutions Inc. All rights reserved.

Information in this document is provided in connection with MACOM Technology Solutions Inc ("MACOM") products. These materials are provided by MACOM as a service to its customers and may be used for informational purposes only. Except as provided in MACOM's Terms and Conditions of Sale for such products or in any separate agreement related to this document, MACOM assumes no liability whatsoever. MACOM assumes no responsibility for errors or omissions in these materials. MACOM may make changes to specifications and product descriptions at any time, without notice. MACOM makes no commitment to update the information and shall have no responsibility whatsoever for conflicts or incompatibilities arising from future changes to its specifications and product descriptions. No license, express or implied, by estoppel or otherwise, to any intellectual property rights is granted by this document.

THESE MATERIALS ARE PROVIDED "AS IS" WITHOUT WARRANTY OF ANY KIND, EITHER EXPRESS OR IMPLIED, RELATING TO SALE AND/OR USE OF MACOM PRODUCTS INCLUDING LIABILITY OR WARRANTIES RELATING TO FITNESS FOR A PARTICULAR PURPOSE, CONSEQUENTIAL OR INCIDENTAL DAMAGES, MERCHANTABILITY, OR INFRINGEMENT OF ANY PATENT, COPYRIGHT OR OTHER INTELLECTUAL PROPERTY RIGHT. MACOM FURTHER DOES NOT WARRANT THE ACCURACY OR COMPLETENESS OF THE INFORMATION, TEXT, GRAPHICS OR OTHER ITEMS CONTAINED WITHIN THESE MATERIALS. MACOM SHALL NOT BE LIABLE FOR ANY SPECIAL, INDIRECT, INCIDENTAL, OR CONSEQUENTIAL DAMAGES, INCLUDING WITHOUT LIMITATION, LOST REVENUES OR LOST PROFITS, WHICH MAY RESULT FROM THE USE OF THESE MATERIALS.

MACOM products are not intended for use in medical, lifesaving or life sustaining applications. MACOM customers using or selling MACOM products for use in such applications do so at their own risk and agree to fully indemnify MACOM for any damages resulting from such improper use or sale.