

## Low Noise Amplifier 0.1 - 3.5 GHz

Rev. V4

### Features

- Single Voltage Supply 3 V ~ 5 V
- Integrated Active Bias Circuit
- Adjustable Current with an External Resistor
- Low Noise Figure
- High Linearity OIP3, 34 dBm @ 2 GHz
- Broadband Match
- Integrated ESD Protection
- RoHS\* Compliant and 260°C Reflow Compatible

### Description

The MAAL-010704 is a high dynamic range single stage MMIC LNA with excellent linearity and low noise figure designed for operation from 0.1 to 3.5 GHz. The LNA is packaged in an RoHS compliant SOT-363 package and requires no external matching components.

This MMIC has an integrated active bias circuit allowing direct connection to 3 V supply and minimizing variation over temperature and process. The bias current can be set with an external resistor to allow the user to customize the current value to fit the application.

The MAAL-010704 offers less than 1 dB noise figure and 34 dBm OIP3 at 2 GHz. The broadband match and single supply operation makes this LNA easy to use and simplifies its implementation while maintaining excellent performance. The low thermal resistance and integrated ESD protection significantly enhances the quality, reliability and ruggedness of this product.

### Functional Block Diagram

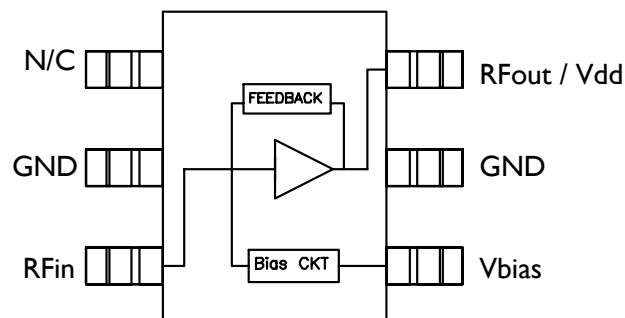

### Pin Configuration<sup>1</sup>

Pin #	Pin Name	Description
1	N/C	No Connection
2, 5 <sup>2</sup>	GND	Ground
3	RF <sub>IN</sub>	RF Input
4	V <sub>BIAS</sub>	Bias Voltage
6	RF <sub>OUT</sub>	RF Output

1. It is recommended that all N/C pins be grounded.
2. Pins 2 and 5 must be connected to RF and thermal ground.

### Ordering Information<sup>3,4</sup>

Part Number	Package
MAAL-010704-000000	bulk quantity
MAAL-010704-TR3000	tape and reel
MAAL-010704-001SMB	evaluation board (100 MHz ~ 3.5 GHz)

3. Reference Application Note M513 for reel size information.
4. All sample boards include 5 loose parts.

\* Restrictions on Hazardous Substances, European Union Directive 2011/65/EU.

## Low Noise Amplifier 0.1 - 3.5 GHz

Rev. V4

### Typical Performance<sup>5,6</sup>: $V_{DD} = 3\text{ V}$ , $I_{DD} = 60\text{ mA}$ , $I_{BIAS} = 8\text{ mA}$ , $T_A = +25^\circ\text{C}$

Parameter	Units	Typical Value								
		0.2	0.5	0.8	1.0	1.5	2.0	2.5	3.0	3.5
Frequency (F)	GHz	0.2	0.5	0.8	1.0	1.5	2.0	2.5	3.0	3.5
Gain (S21)	dB	22.0	21.5	19.5	18.5	16.0	14.0	12.5	11.0	10.0
Output IP3 (OIP3)	dBm	33.2	34.9	36.7	33.7	34.0	34.5	35.0	36.7	37.2
Output P1dB (P1dB)	dBm	17.0	18.0	18.6	18.3	18.8	19.1	19.0	19.1	18.4
Input Return Loss (S11)	dB	-11.0	-13.0	-13.0	-12.7	-12.0	-11.4	-10.5	-10.0	-9.1
Output Return Loss (S22)	dB	-19.0	-26.0	-23.0	-22.0	-20.5	-20.5	-20.0	-19.5	-20.0
Noise Figure (NF)	dB	0.70	0.80	0.75	0.74	0.75	0.84	0.93	1.10	1.20

### Typical Performance<sup>5,6</sup>: $V_{DD} = 5\text{ V}$ , $I_{DD} = 60\text{ mA}$ , $I_{BIAS} = 8\text{ mA}$ , $T_A = +25^\circ\text{C}$

Parameter	Units	Typical Value								
		0.2	0.5	0.8	1.0	1.5	2.0	2.5	3.0	3.5
Frequency (F)	GHz	0.2	0.5	0.8	1.0	1.5	2.0	2.5	3.0	3.5
Gain (S21)	dB	22.0	21.5	19.5	18.5	16.0	14.0	12.5	11.0	10.0
Output IP3 (OIP3)	dBm	31.8	34.0	35.0	36.5	36.2	36.5	37.1	37.6	36.8
Output P1dB (P1dB)	dBm	22.0	21.0	22.0	21.9	22.2	22.2	22.4	22.4	22.1
Input Return Loss (S11)	dB	-11.0	-13.0	-13.0	-12.7	-12.0	-11.5	-10.5	-10.0	-9.0
Output Return Loss (S22)	dB	-22.0	-26.0	-20.0	-19.0	-17.5	-17.0	-17.0	-16.5	-17.0
Noise Figure (NF)	dB	0.80	0.84	0.80	0.78	0.80	0.90	1.0	1.16	1.28

5. Typical values presented in the above table were obtained by measurements using RF probes in a 50  $\Omega$  system.

6.  $P_{OUT} = 5\text{ dBm}$ , Tone Spacing = 1 MHz

### Electrical Specifications<sup>7,8</sup>: 2 GHz ( $T_A = +25^\circ\text{C}$ , $V_{DD} = 3\text{ V}$ , $Z_0 = 50\ \Omega$ )

Parameter	Units	Min.	Typ.	Max.
Small Signal Gain (S21)	dB	12.5	14.3	—
Output Intercept Point (OIP3)	dBm	—	34.5	—
Output P1dB	dBm	17.0	18.6	—
Quiescent Current ( $I_{DD}$ )	mA	—	60.0	75.0
Noise Figure (NF)	dB	—	0.95	—

7. Unless otherwise specified, the specifications are guaranteed at room temperature in a MACOM test fixture.

8. Typical values presented in the above table are based on data from multiple wafer lots and evaluation board MAAL-010704-001SMB.

### Absolute Maximum Ratings<sup>9,10</sup>

Parameter	Absolute Max.
Supply Voltage ( $V_{DD}$ )	5.5 V
Current ( $I_{DQ}$ )	100 mA
Bias Current ( $I_{BIAS}$ )	15 mA
Power Dissipation ( $P_{DISS}$ )	600 mW
RF Input Power ( $P_{IN}$ )	24 dBm
Storage Temperature ( $T_{STG}$ )	-55°C to +150°C
Operating Temperature <sup>11</sup> ( $T_C$ )	-40°C to +95°C
Junction Temperature <sup>11</sup> ( $T_J$ )	+150°C
Thermal Resistance	104°C/W
ESD (HBM)	Class 1A
Moisture Sensitivity Level	MSL1

9. Exceeding any one or combination of these limits may cause permanent damage to this device.  
 10. MACOM does not recommend sustained operation near these survivability limits.  
 11. Junction Temperature ( $T_J$ ) =  $T_C + \Theta_{JC} * ((V * I) - (P_{OUT} - P_{IN}))$ .

### Component Values

Ref Designator	Description
C1, C4, C5	1 nF 0402 Capacitor
C6	10 nF 0402 Capacitor
C9	100 $\mu$ F Tantalum Capacitor Size C
L2	82 nH 0402 Inductor
L3 or R1 <sup>12</sup>	Please refer to $R_{BIAS}$ vs. $I_{DQ}$ plot to select the appropriate R1 value
C2, C3, C7, C8, L1, L3	DNP

12.  $V_{BIAS}$  can be connected separate of  $V_{DD}$  to control the drain current. When  $V_{BIAS}$  is connected directly either a resistor is used to drop the voltage down from 3 V, or if the exact bias voltage (~2 V) is applied, then an inductor L3 can be used.

### Evaluation Board Schematic

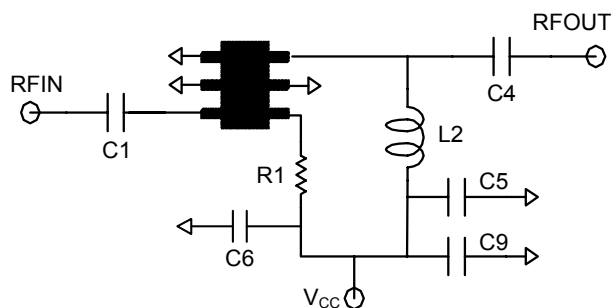

### Evaluation Board (MAAL-010704-001SMB)

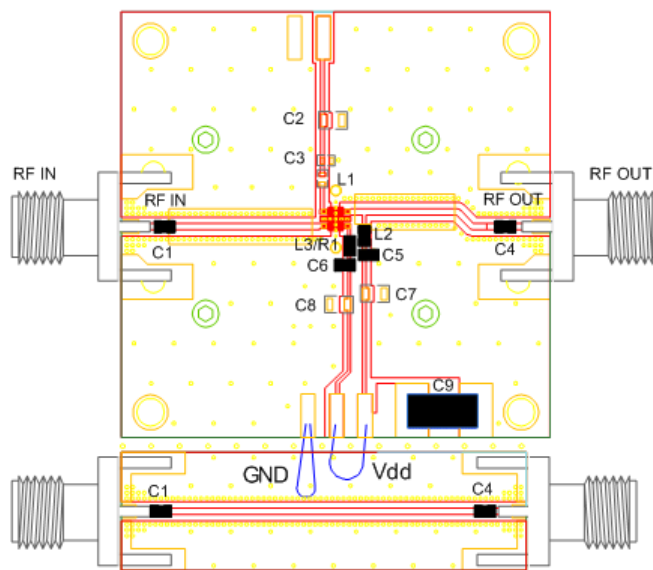

## Typical Performance: $R_{BIAS}$ vs. Current<sup>13</sup>

**IDQ vs.  $R_{BIAS}$  @ 3 V**

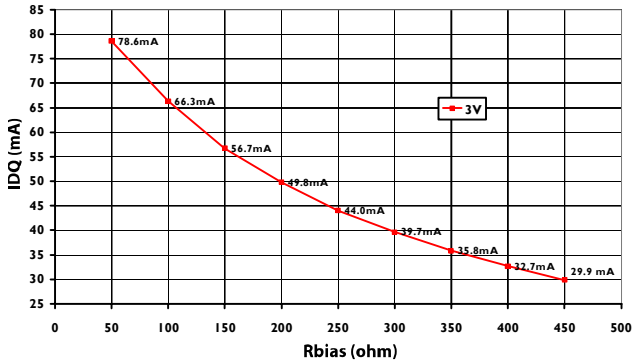

**IDQ vs.  $R_{BIAS}$  @ 5 V**

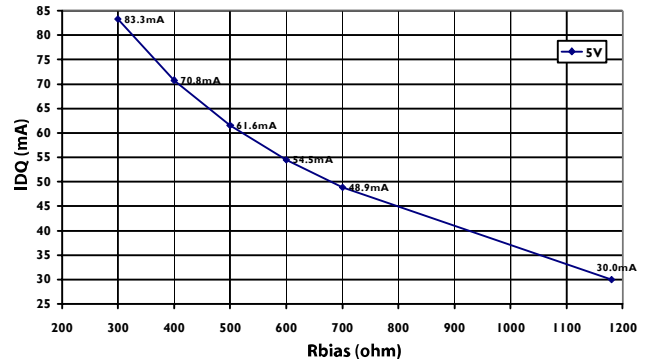

13. IDQ represents the total current of drain current ( $I_{DD}$ ) and bias current ( $I_{BIAS}$ ) combined. The resistor ( $R_{BIAS}$ ) is connected between pin 4 ( $V_{BIAS}$ ) and pin 6 (RF out /  $V_{DD}$ ).

## Typical Performance<sup>14</sup>: Total Current vs. $P_{OUT}$ vs. Voltage

**IDQ = 30 mA**

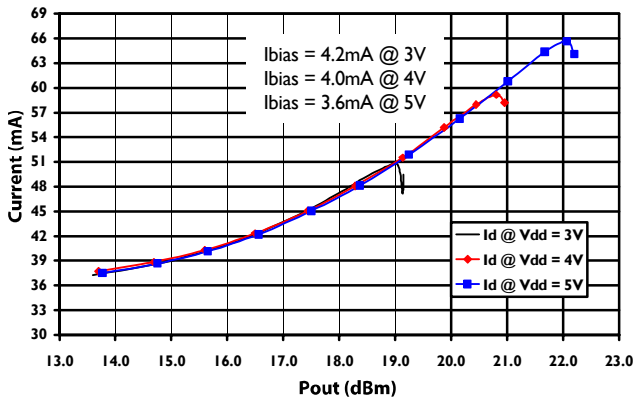

**IDQ = 60 mA**

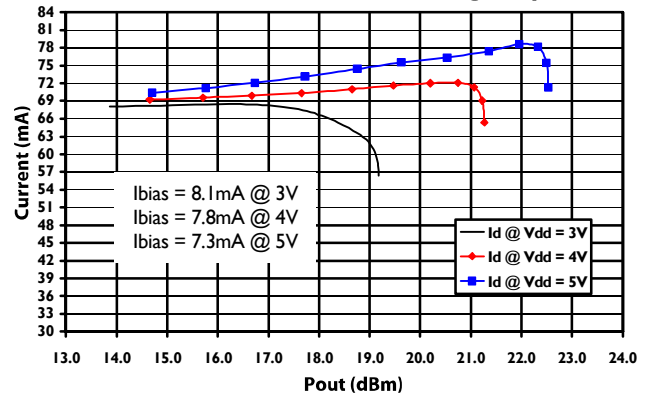

## Low Noise Amplifier 0.1 - 3.5 GHz

Rev. V4

### Typical Performance Curves<sup>14</sup>: 3 V, 30 mA (over temperature)

**Input Return Loss**

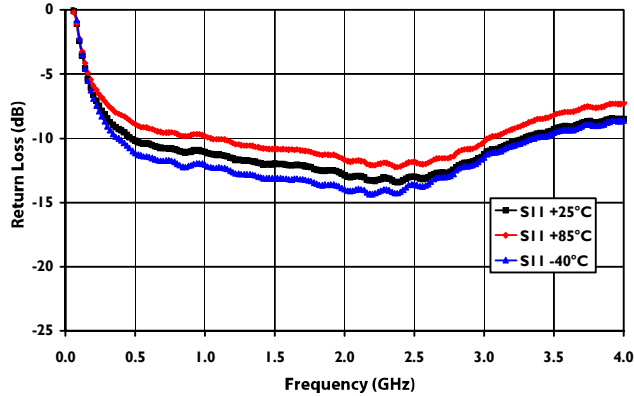

**Output Return Loss**

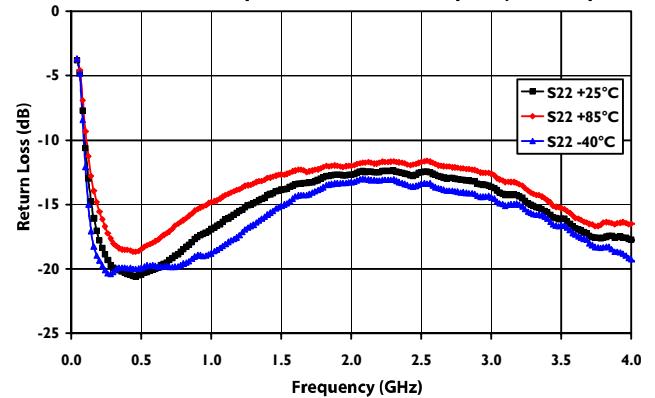

**Gain**

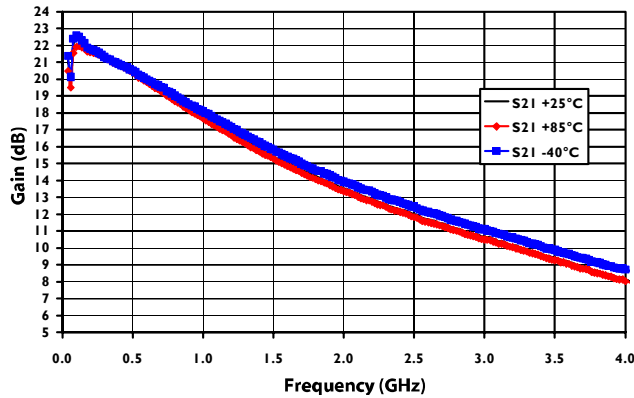

**Noise Figure**

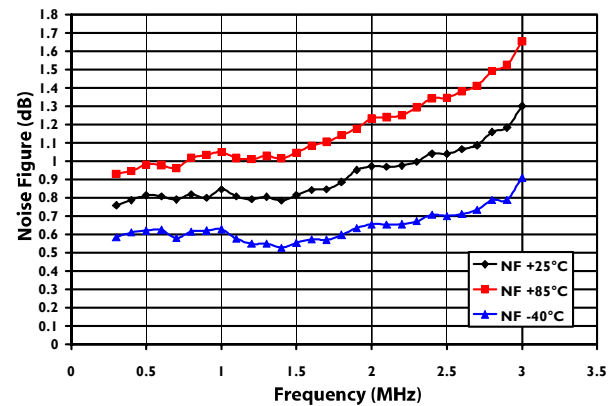

**OIP3**

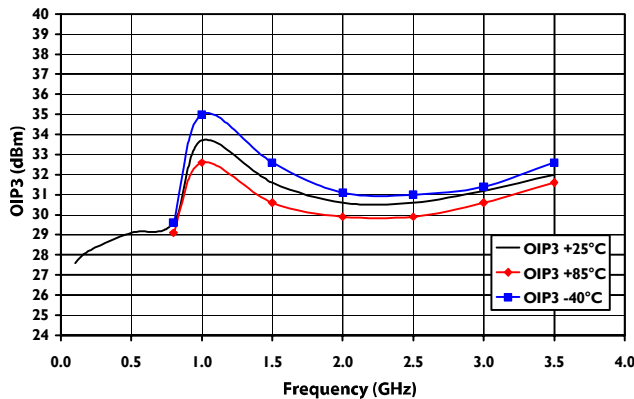

**P1dB**

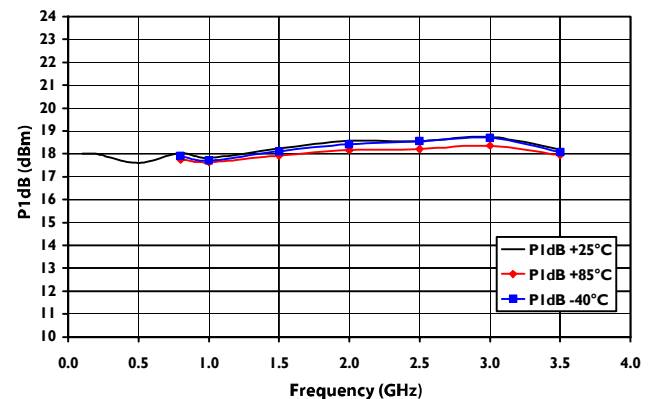

## Low Noise Amplifier 0.1 - 3.5 GHz

Rev. V4

### Typical Performance Curves<sup>14</sup>: 3 V, 60 mA (over temperature)

**Input Return Loss**

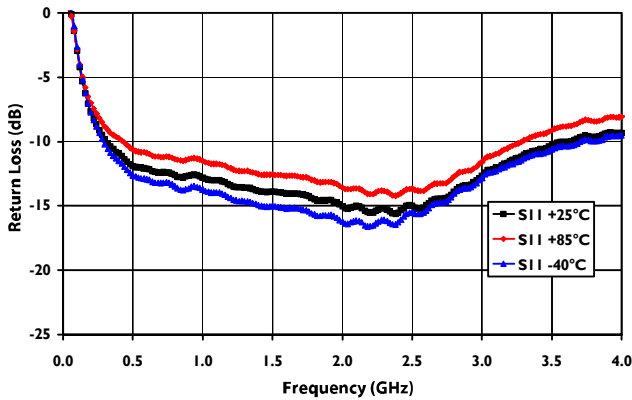

**Output Return Loss**

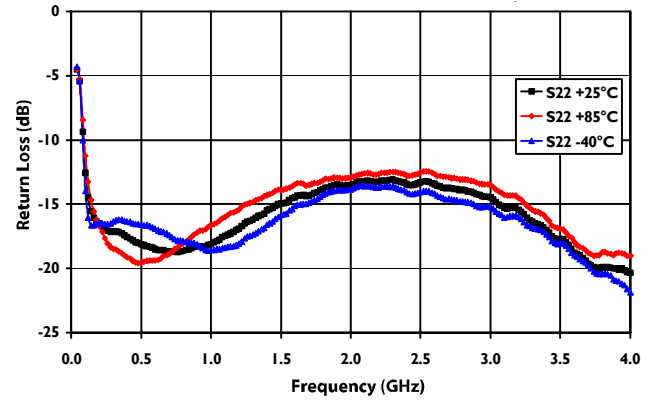

**Gain**

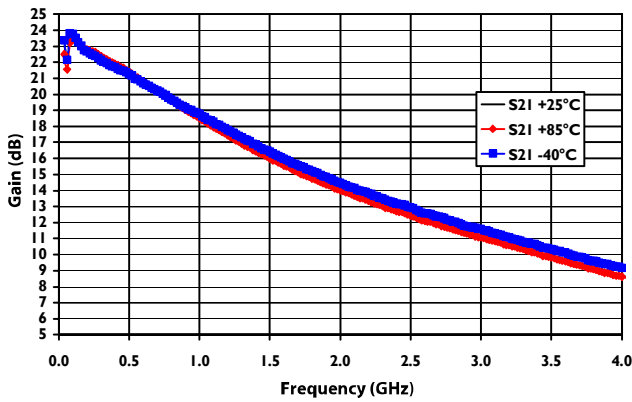

**Noise Figure**

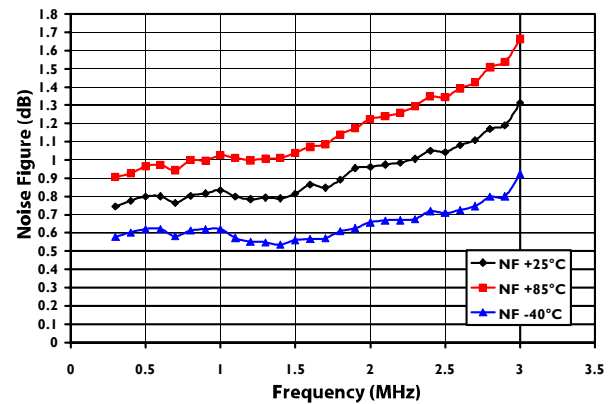

**OIP3**

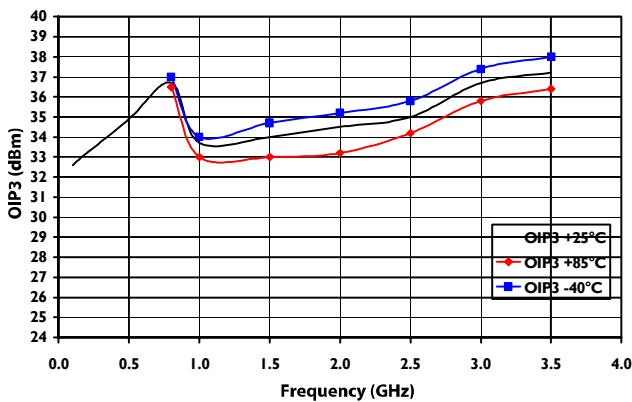

**P1dB**

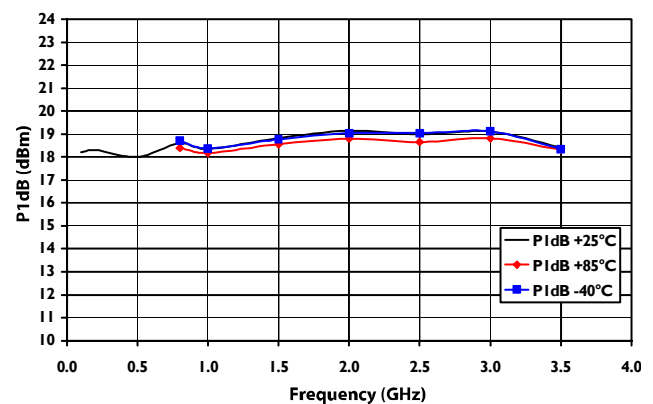

## Low Noise Amplifier 0.1 - 3.5 GHz

Rev. V4

Typical Performance Curves<sup>14</sup>: 5 V, 30 mA (over temperature)

**Input Return Loss**

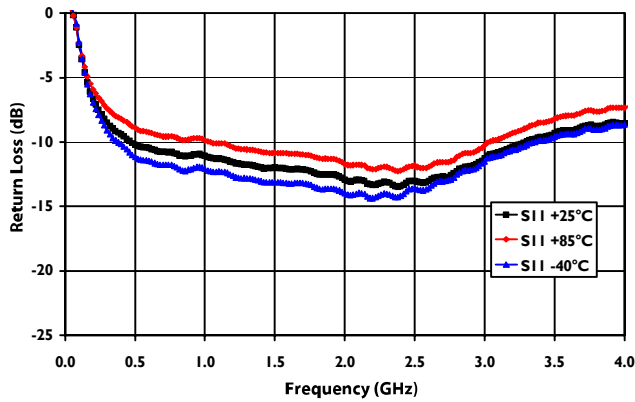

**Output Return Loss**

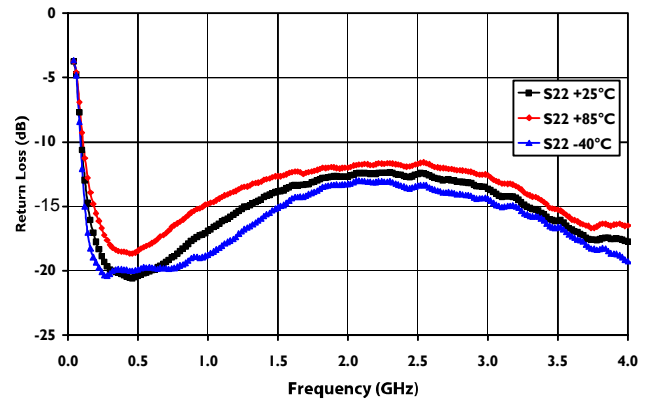

**Gain**

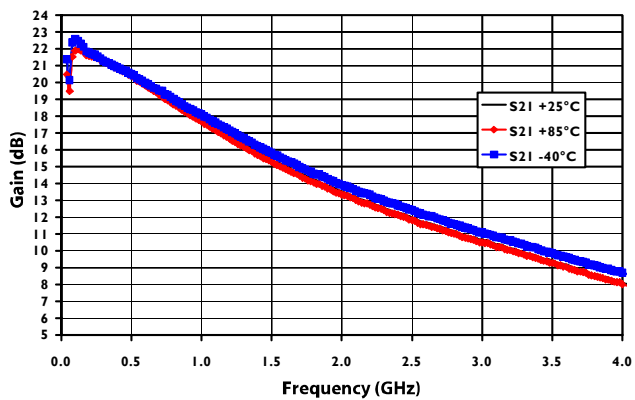

**Noise Figure**

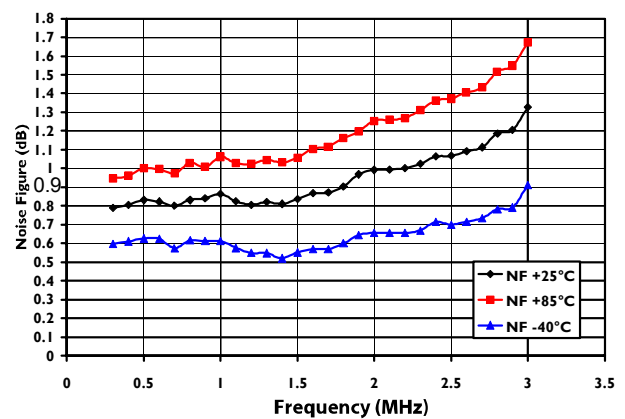

**OIP3**

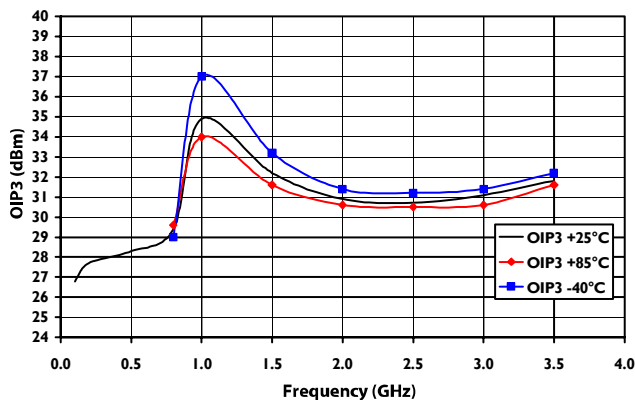

**P1dB**

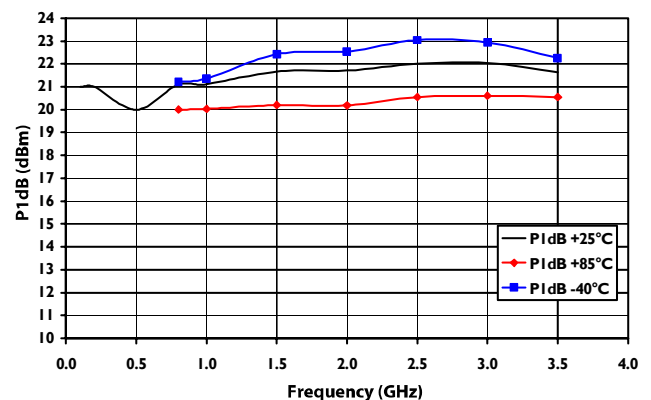

## Low Noise Amplifier 0.1 - 3.5 GHz

Rev. V4

### Typical Performance Curves<sup>14</sup>: 5 V, 60 mA (over temperature)

**Input Return Loss**

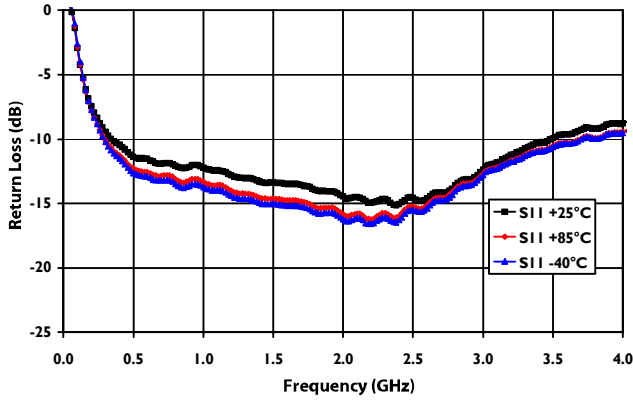

**Output Return Loss**

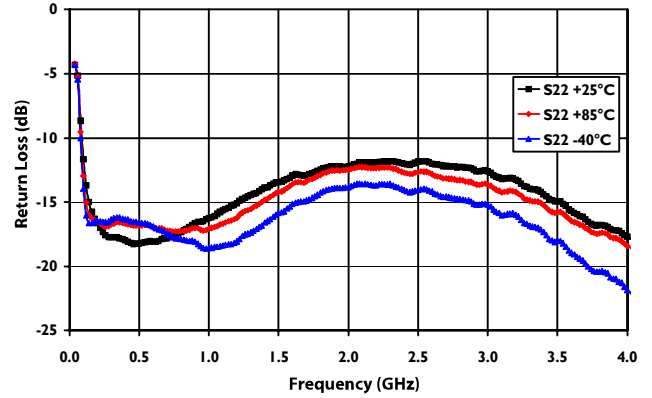

**Gain**

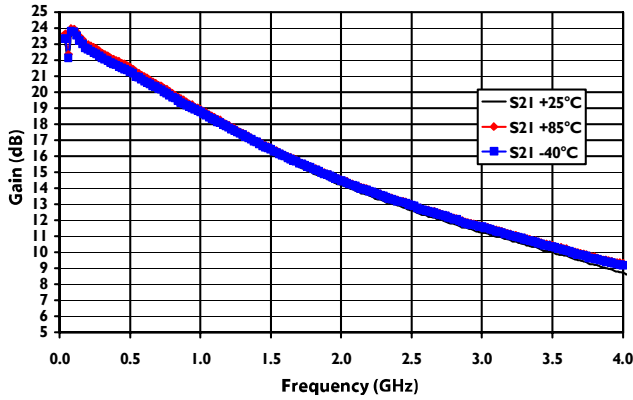

**Noise Figure**

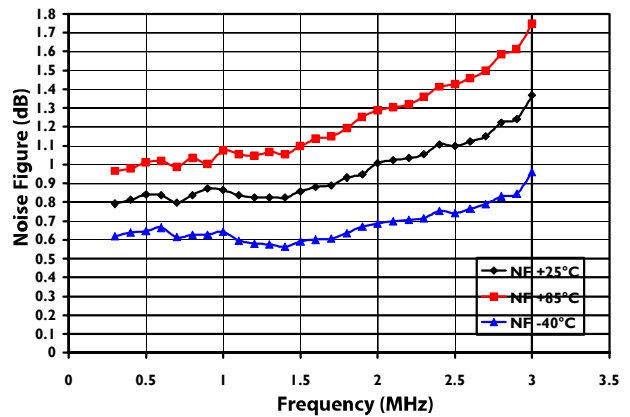

**OIP3**

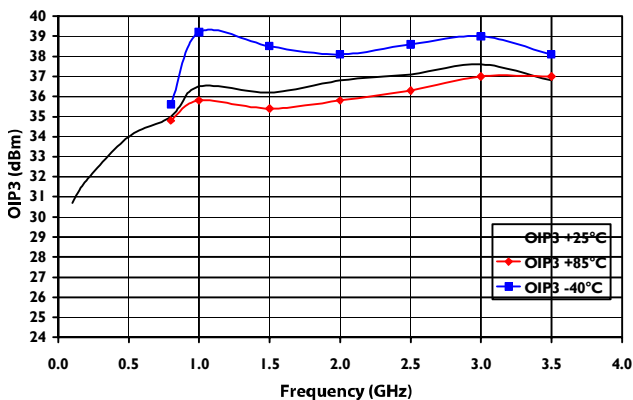

**P1dB**

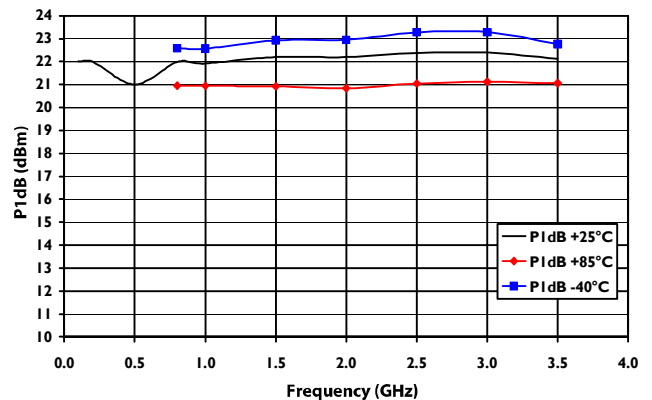

14. Graphs were generated using evaluation board MAAL-010704-001SMB.



## Typical S-Parameters<sup>15</sup>

**Reverse Isolation**

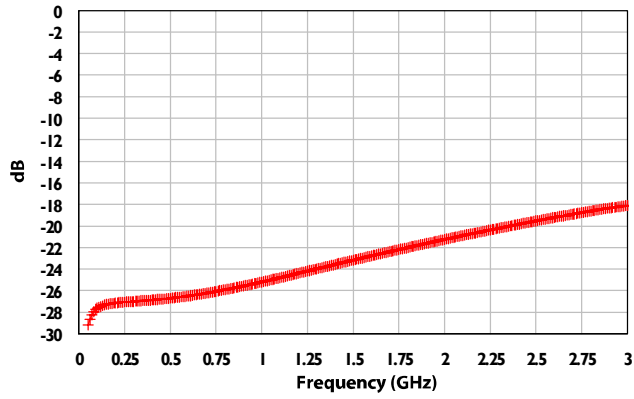

**Gain**

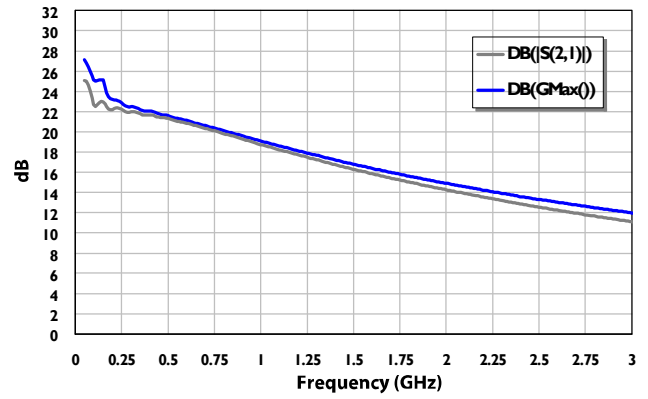

**Output Return Loss**

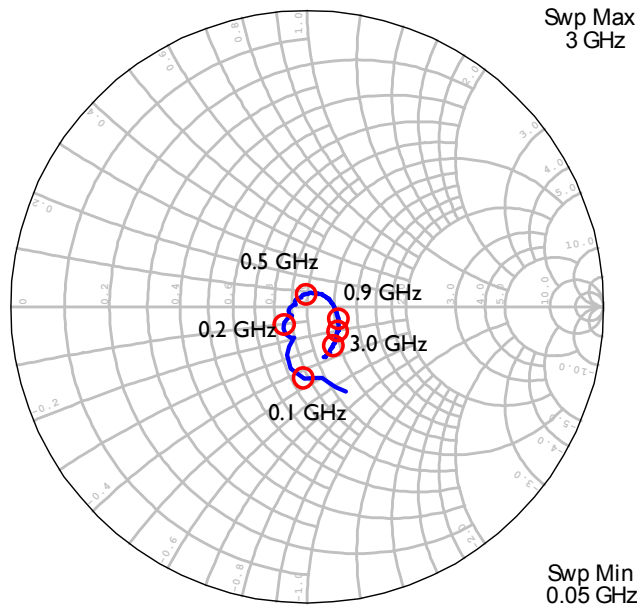

**Input Return Loss**

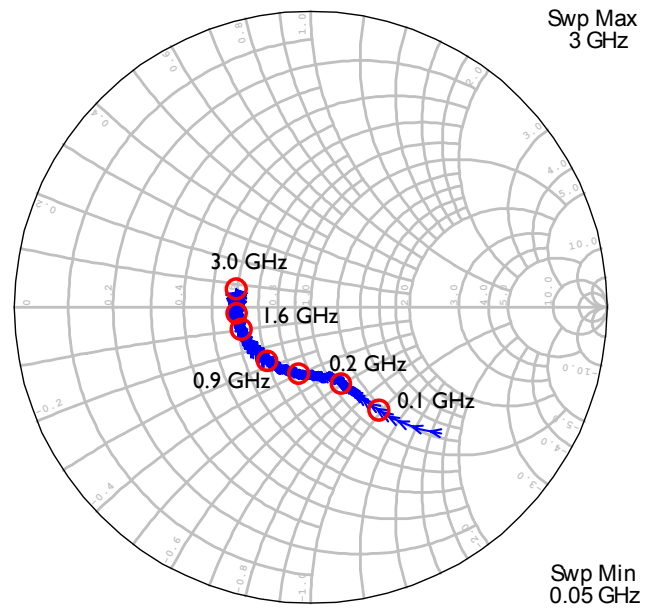

15. S-Parameters files in S2P format are available for download at [macom.com](http://macom.com).

## Evaluation Board Schematic @ 100 MHz

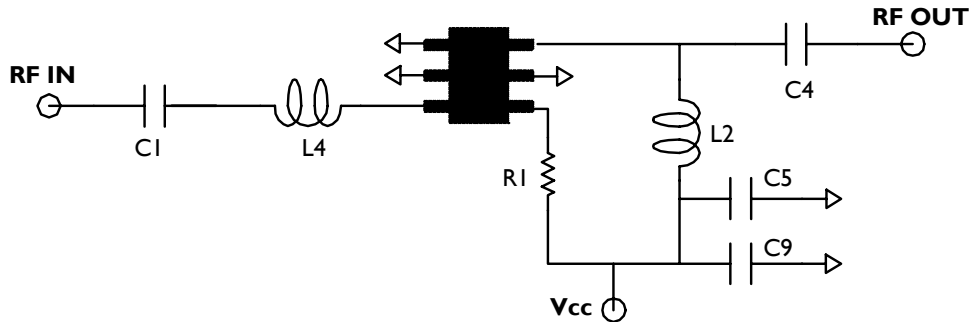

### Typical Performance: 3 V, 60 mA

Parameter	Units	TYP
Frequency	GHz	0.1
Gain	dB	25.5
Output IP3 <sup>16</sup>	dBm	31.5
Output P1dB	dBm	17.5
Input Return Loss	dB	-11.0
Output Return Loss	dB	-11.0
Noise Figure	dB	1.85

### Component Values

Ref. Designator	Description
C1, C4	1 nF 0402 Capacitor
C5	10 nF 0402 Capacitor
C9	100 $\mu$ F Tantalum Capacitor Size C
L2	150 nH 0603 Inductor
L4	68 nH 0402 Inductor
R1	Refer to R <sub>BIAS</sub> vs. I <sub>DD</sub> plot
C2, C3, C6, C7, C8, L1, L3	DNP

16. P<sub>OUT</sub> = 5 dBm, Tone Spacing = 1 MHz

### S-Parameters using 100 MHz evaluation board

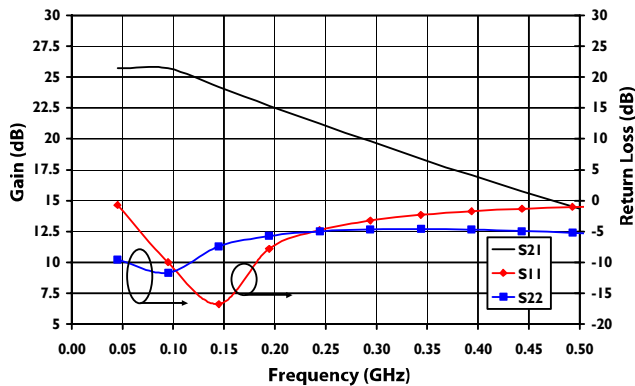

### Evaluation Board Schematic @ 200 MHz

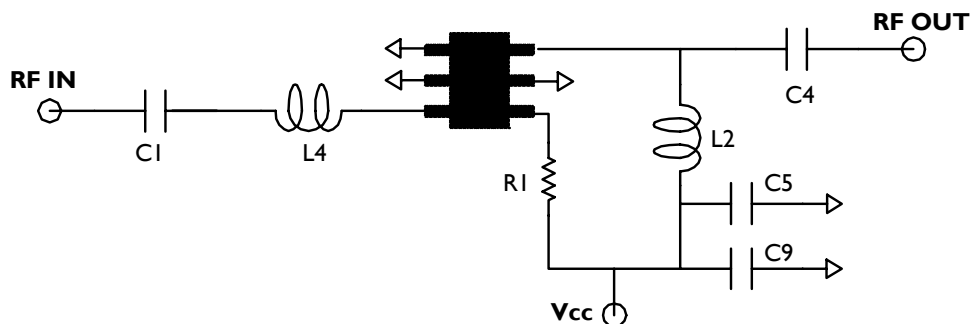

### Typical Performance: 3 V, 60 mA

Parameter	Units	TYP
Frequency	GHz	0.2
Gain	dB	23.0
Output IP3 <sup>17</sup>	dBm	33.5
Output P1dB	dBm	18.4
Input Return Loss	dB	-20.0
Output Return Loss	dB	-14.0
Noise Figure	dB	1.1

### Component Values

Ref Designator	Description
C1, C4	1 nF 0402 Capacitor
C5	10 nF 0402 Capacitor
C9	100 $\mu$ F Tantalum Capacitor Size C
L2	150 nH 0603 Inductor
L4	24 nH 0402 Inductor
R1	Refer to R <sub>BIAS</sub> vs. I <sub>DD</sub> plot
C2, C3, C6, C7, C8, L1, L3	DNP

17. P<sub>OUT</sub> = 5 dBm, Tone Spacing = 1 MHz

### S-Parameters using 200 MHz evaluation board

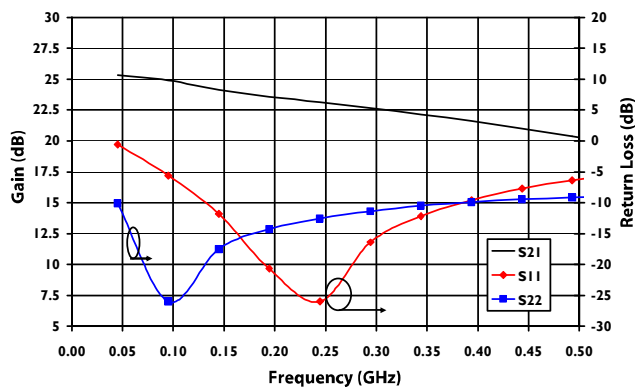

Typical Noise Parameters:  $V_D = 3\text{ V}$ ,  $+25^\circ\text{C}$ ,  $Z_0 = 50\ \Omega$

$I_D = 20\text{ mA}$

Freq (GHz)	NF <sub>min</sub> (dB)	$\Gamma_{opt}$ Mag.	$\Gamma_{opt}$ Ang.	R <sub>n/50</sub>	NF <sub>50Ω</sub> (dB)
0.80	0.80	0.08	136.5	0.08	0.81
0.90	0.77	0.11	133.6	0.07	0.78
1.00	0.78	0.12	132.5	0.08	0.78
1.50	0.81	0.17	-176.6	0.06	0.82
2.00	0.88	0.31	-156.0	0.06	0.89
2.50	0.96	0.32	-139.3	0.08	0.97
3.00	1.12	0.35	-108.1	0.13	1.13
3.50	1.26	0.40	-93.6	0.19	1.28
4.00	1.33	0.43	-64.1	0.36	1.36

$I_D = 30\text{ mA}$

Freq (GHz)	NF <sub>min</sub> (dB)	$\Gamma_{opt}$ Mag.	$\Gamma_{opt}$ Ang.	R <sub>n/50</sub>	NF <sub>50Ω</sub> (dB)
0.80	0.77	0.07	153.4	0.07	0.77
0.90	0.73	0.10	145.8	0.07	0.74
1.00	0.75	0.12	145.3	0.07	0.75
1.50	0.76	0.16	-168.2	0.07	0.76
2.00	0.84	0.31	-155.7	0.06	0.85
2.50	0.92	0.32	-135.2	0.08	0.93
3.00	1.07	0.32	-104.9	0.14	1.08
3.50	1.20	0.37	-92.3	0.20	1.21
4.00	1.29	0.44	-61.6	0.33	1.31

$I_D = 60\text{ mA}$

Freq (GHz)	NF <sub>min</sub> (dB)	$\Gamma_{opt}$ Mag.	$\Gamma_{opt}$ Ang.	R <sub>n/50</sub>	NF <sub>50Ω</sub> (dB)
0.80	0.76	0.07	160.5	0.07	0.76
0.90	0.73	0.09	150.5	0.07	0.73
1.00	0.74	0.12	154.2	0.07	0.74
1.50	0.75	0.17	-158.5	0.07	0.76
2.00	0.84	0.29	-151.8	0.06	0.85
2.50	0.93	0.30	-129.9	0.08	0.94
3.00	1.09	0.31	-99.9	0.14	1.10
3.50	1.21	0.43	-88.5	0.19	1.22
4.00	1.31	0.44	-60.0	0.32	1.33

Typical Noise Parameters:  $V_D = 5\text{ V}$ ,  $+25^\circ\text{C}$ ,  $Z_0 = 50\ \Omega$

$I_D = 20\text{ mA}$

Freq (GHz)	NF <sub>min</sub> (dB)	$\Gamma_{opt}$ Mag.	$\Gamma_{opt}$ Ang.	R <sub>n/50</sub>	NF <sub>50Ω</sub> (dB)
0.80	0.81	0.08	135.0	0.08	0.81
0.90	0.78	0.11	132.0	0.08	0.78
1.00	0.78	0.11	129.4	0.08	0.79
1.50	0.81	0.17	-175.2	0.07	0.81
2.00	0.89	0.30	-161.9	0.06	0.89
2.50	0.97	0.32	-139.7	0.08	0.97
3.00	1.14	0.34	-109.3	0.14	1.15
3.50	1.23	0.40	-92.9	0.21	1.25
4.00	1.33	0.44	-65.7	0.34	1.36

$I_D = 30\text{ mA}$

Freq (GHz)	NF <sub>min</sub> (dB)	$\Gamma_{opt}$ Mag.	$\Gamma_{opt}$ Ang.	R <sub>n/50</sub>	NF <sub>50Ω</sub> (dB)
0.80	0.78	0.07	148.4	0.08	0.79
0.90	0.75	0.10	142.0	0.07	0.76
1.00	0.77	0.12	142.6	0.07	0.78
1.50	0.78	0.16	-165.7	0.07	0.79
2.00	0.87	0.30	-156.3	0.06	0.87
2.50	0.95	0.32	-135.2	0.08	0.96
3.00	1.10	0.32	-105.6	0.14	1.11
3.50	1.23	0.41	-89.1	0.20	1.25
4.00	1.31	0.47	-62.1	0.31	1.33

$I_D = 60\text{ mA}$

Freq (GHz)	NF <sub>min</sub> (dB)	$\Gamma_{opt}$ Mag.	$\Gamma_{opt}$ Ang.	R <sub>n/50</sub>	NF <sub>50Ω</sub> (dB)
0.80	0.81	0.09	153.5	0.08	0.81
0.90	0.77	0.09	149.7	0.08	0.78
1.00	0.78	0.11	149.3	0.08	0.79
1.50	0.81	0.16	-160.0	0.07	0.81
2.00	0.90	0.30	-151.6	0.06	0.90
2.50	0.99	0.30	-130.2	0.09	1.00
3.00	1.16	0.31	-100.7	0.15	1.17
3.50	1.28	0.38	-88.1	0.23	1.30
4.00	1.37	0.43	-57.8	0.36	1.40

**Lead-Free SC70-6LD (SOT-363)<sup>†</sup>**

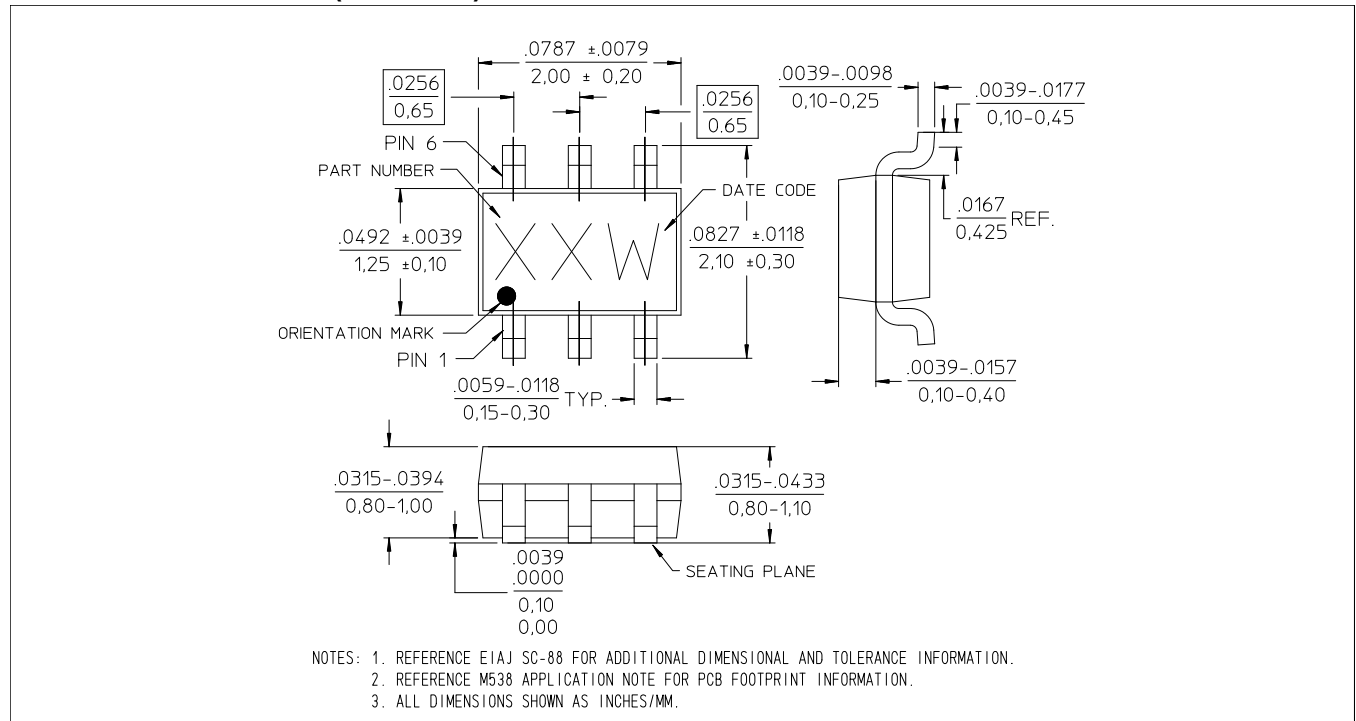

<sup>†</sup> Reference Application Note M538 for lead-free solder reflow recommendations.  
Meets JEDEC moisture sensitivity level 1 requirements.  
Plating is 100% matte tin over copper.

## Handling Procedures

Please observe the following precautions to avoid damage:

## Static Sensitivity

Gallium Arsenide Integrated Circuits are sensitive to electrostatic discharge (ESD) and can be damaged by static electricity. Proper ESD control techniques should be used when handling these class 2 devices.

## Applications Section: Low Current, 700 - 800 MHz

### Description

The MAAL-010704 is designed to work as a low noise gain block over a wide range of frequencies in a 50  $\Omega$  environment. Input and output can be tuned to improve performance over a specific frequency band. This evaluation board has been designed for tuning flexibility. The recommended schematic and parts list give the component details needed to tune the MAAL-010704 for operation from 700 - 800 MHz.

### Recommended Schematic

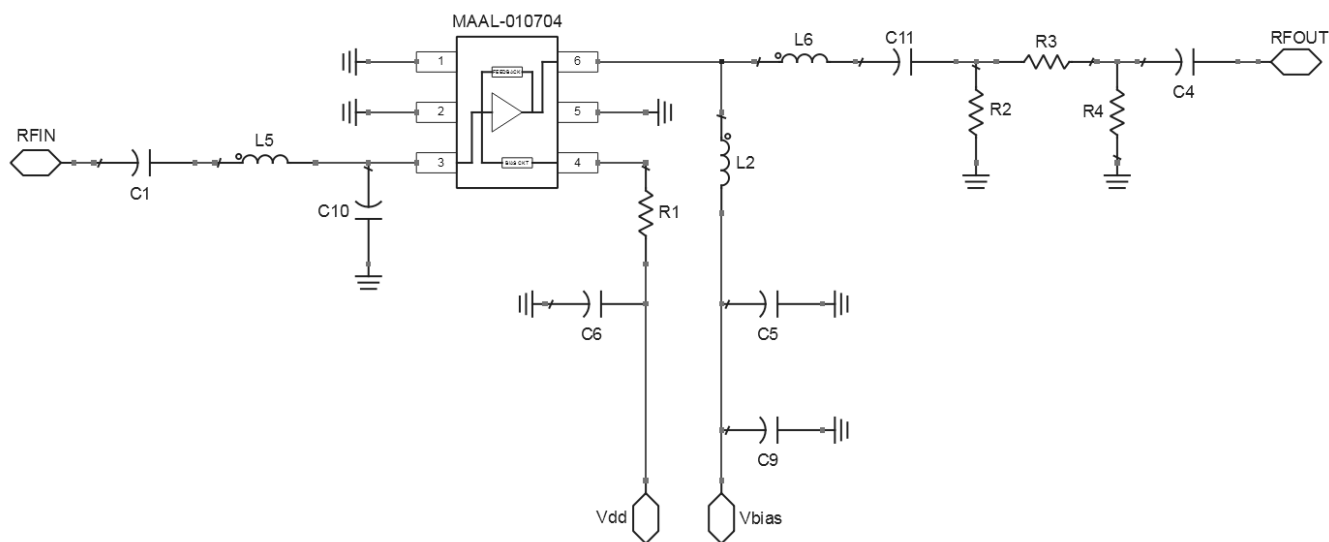

### Typical Performance: 3.3 V, 18 mA @ 760 MHz

Parameter	Units	Typical
Gain	dB	14.5
Reverse Isolation	dB	28.0
Output P1dB	dBm	13.0
Input Return Loss	dB	23.0
Output Return Loss	dB	26.0
Noise Figure	dB	1.5

### Parts List: 700 - 800 MHz

Ref Designator	Description
C1	1.5 pF 0402 Capacitor
C4, C5, C6	10 nF 0402 Capacitor
C9	100 $\mu$ F Tantalum, Capacitor Size C
C10	1.0 pF 0402 Capacitor
C11	82 pF 0402 Capacitor
L2 <sup>18</sup>	82 nH 0402 Inductor
L5 <sup>18</sup>	20 nH 0402 Inductor
L6 <sup>18</sup>	6.8 nH 0402 Inductor
R1	910 $\Omega$ 0402 Resistor
R2, R4	220 $\Omega$ 0402 Resistor
R3	22 $\Omega$ 0402 Resistor
C2, C3, C7, C8, L1	DNP

18. Coilcraft Wirewound 0402HP Inductors

**Applications Section: Low Current, 700 - 800 MHz**

**Typical Performance Curves: 3.3 V, 18 mA (over temperature)**

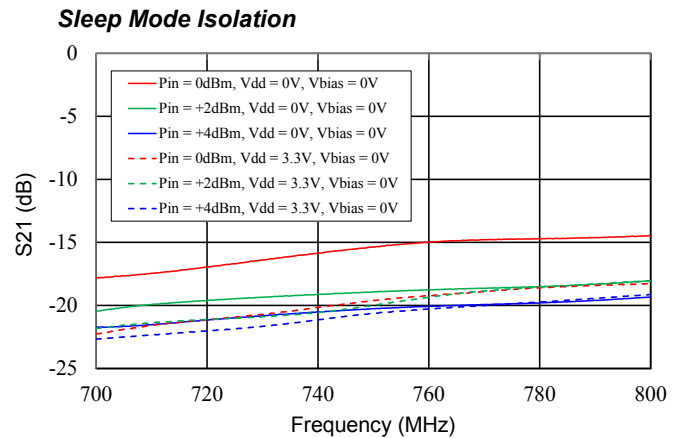
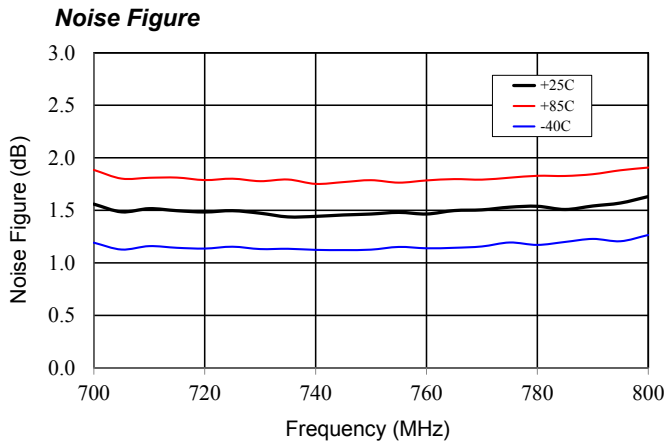
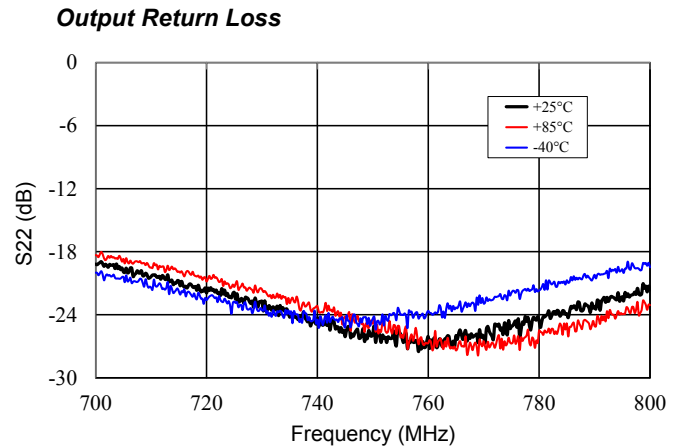
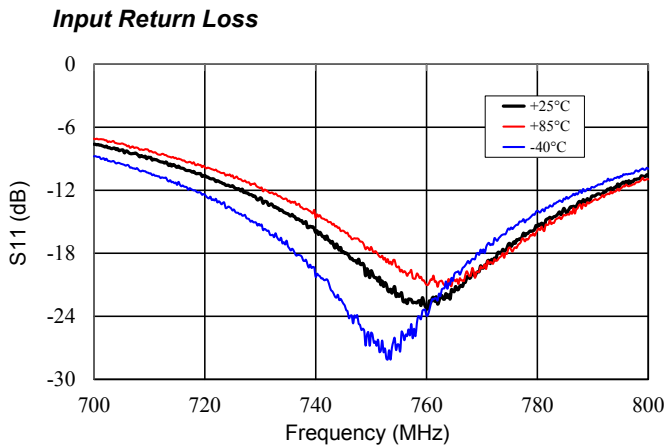
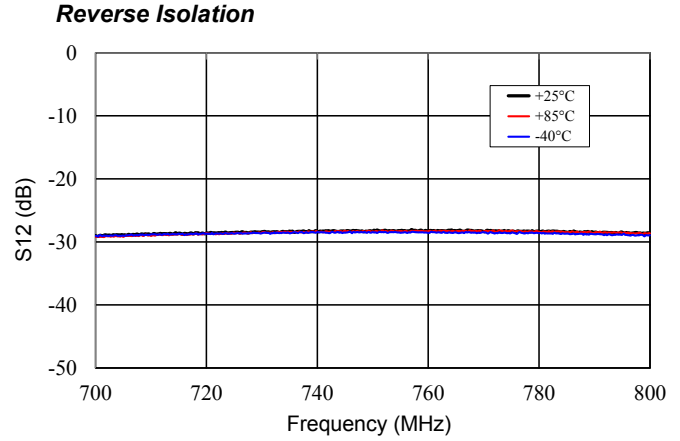
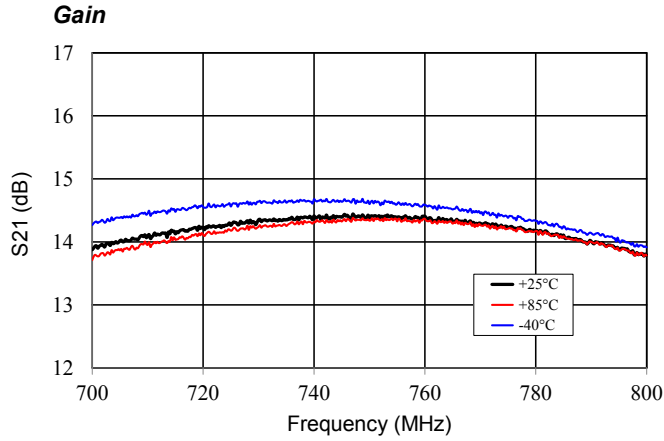



MACOM Technology Solutions Inc. All rights reserved.

Information in this document is provided in connection with MACOM Technology Solutions Inc ("MACOM") products. These materials are provided by MACOM as a service to its customers and may be used for informational purposes only. Except as provided in MACOM's Terms and Conditions of Sale for such products or in any separate agreement related to this document, MACOM assumes no liability whatsoever. MACOM assumes no responsibility for errors or omissions in these materials. MACOM may make changes to specifications and product descriptions at any time, without notice. MACOM makes no commitment to update the information and shall have no responsibility whatsoever for conflicts or incompatibilities arising from future changes to its specifications and product descriptions. No license, express or implied, by estoppel or otherwise, to any intellectual property rights is granted by this document.

THESE MATERIALS ARE PROVIDED "AS IS" WITHOUT WARRANTY OF ANY KIND, EITHER EXPRESS OR IMPLIED, RELATING TO SALE AND/OR USE OF MACOM PRODUCTS INCLUDING LIABILITY OR WARRANTIES RELATING TO FITNESS FOR A PARTICULAR PURPOSE, CONSEQUENTIAL OR INCIDENTAL DAMAGES, MERCHANTABILITY, OR INFRINGEMENT OF ANY PATENT, COPYRIGHT OR OTHER INTELLECTUAL PROPERTY RIGHT. MACOM FURTHER DOES NOT WARRANT THE ACCURACY OR COMPLETENESS OF THE INFORMATION, TEXT, GRAPHICS OR OTHER ITEMS CONTAINED WITHIN THESE MATERIALS. MACOM SHALL NOT BE LIABLE FOR ANY SPECIAL, INDIRECT, INCIDENTAL, OR CONSEQUENTIAL DAMAGES, INCLUDING WITHOUT LIMITATION, LOST REVENUES OR LOST PROFITS, WHICH MAY RESULT FROM THE USE OF THESE MATERIALS.

MACOM products are not intended for use in medical, lifesaving or life sustaining applications. MACOM customers using or selling MACOM products for use in such applications do so at their own risk and agree to fully indemnify MACOM for any damages resulting from such improper use or sale.