

CHIP COIL (CHIP INDUCTORS) LQW04AN□□□□00D REFERENCE SPECIFICATION

1. Scope

This reference specification applies to LQW04AN series, Chip coil (Chip Inductors).

2. Part Numbering

(ex)

LQ	W	04	A	N	1N1	D	0	0	D
Product ID	Structure	Dimension (L×W)	Applications and Characteristics	Category	Inductance	Tolerance	Features	Electrode	Packaging D:Taping *B:Bulk

*Bulk packing also available. (A product is put in the plastic bag under the taping conditions.)

3. Rating

- Operating Temperature Range -55°C to $+125^{\circ}\text{C}$
- Storage Temperature Range. -55°C to $+125^{\circ}\text{C}$

Customer Part Number	MURATA Part Number	Inductance		Q (min.)	DC Resistance (Q max.)	Self Resonant Frequency (MHz min.)	Rated Current (mA)
		(nH)	Tolerance				
	LQW04AN0N8C00D	0.8		23	0.02		1800
	LQW04AN0N8D00D						
	LQW04AN1N1C00D	1.1		15	0.03	20.0	990
	LQW04AN1N1D00D						
	LQW04AN1N3C00D	1.3		15	0.03	20.0	1500
	LQW04AN1N3D00D						
	LQW04AN1N4C00D	1.4		18	0.05		1200
	LQW04AN1N4D00D						
	LQW04AN1N5C00D	1.5		18	0.05		940
	LQW04AN1N5D00D						
	LQW04AN1N6C00D	1.6		15	0.06	17.0	700
	LQW04AN1N6D00D						
	LQW04AN1N7C00D	1.7		15	0.06	17.0	700
	LQW04AN1N7D00D						
	LQW04AN1N8C00D	1.8		10	0.12	15.0	490
	LQW04AN1N8D00D						
	LQW04AN1N9C00D	1.9		10	0.12	15.0	490
	LQW04AN1N9D00D						
	LQW04AN2N0C00D	2.0		21	0.03	20.0	1100
	LQW04AN2N0D00D						
	LQW04AN2N1C00D	2.1		14	0.04	12.0	1100
	LQW04AN2N1D00D						
	LQW04AN2N2C00D	2.2		21	0.04		780
	LQW04AN2N2D00D						
	LQW04AN2N3C00D	2.3		18	0.07	20.0	570
	LQW04AN2N3D00D						
	LQW04AN2N4C00D	2.4		15	0.12	15.0	490
	LQW04AN2N4D00D						
	LQW04AN2N5C00D	2.5		10	0.12	10.0	490
	LQW04AN2N5D00D						
	LQW04AN2N6C00D	2.6		15	0.07	15	620
	LQW04AN2N6D00D						
	LQW04AN2N7C00D	2.7		15	0.07	15	570
	LQW04AN2N7D00D						
	LQW04AN2N8C00D	2.8		10	0.12	13.0	620
	LQW04AN2N8D00D						
	LQW04AN2N9C00D	2.9		10	0.12	13.0	490
	LQW04AN2N9D00D						
	LQW04AN3N0C00D	3.0		15	0.07	13.0	620
	LQW04AN3N0D00D						
	LQW04AN3N1C00D	3.1		10	0.12	10.0	490
	LQW04AN3N1D00D						

Customer Part Number	MURATA Part Number	Inductance		Q (min.)	DC Resistance (Ω max.)	Self Resonant Frequency (MHz min.)	Rated Current (mA)	
		(nH)	Tolerance					
	LQW04AN3N2C00D	3.2		10	0.17	9.0	400	
	LQW04AN3N2D00D							
	LQW04AN3N3C00D	3.3			15	0.14	10.0	440
	LQW04AN3N3D00D							
	LQW04AN3N4C00D	3.4				0.27	8.0	310
	LQW04AN3N4D00D							
	LQW04AN3N6C00D	3.6		15	0.10	13.0	530	
	LQW04AN3N6D00D							
	LQW04AN3N7C00D	3.7		20	0.14	10.0	440	
	LQW04AN3N7D00D							
	LQW04AN3N8C00D	3.8		15	0.10	11.0	530	
	LQW04AN3N8D00D							
	LQW04AN3N9C00D	3.9				12.0		11.0
	LQW04AN3N9D00D							
	LQW04AN4N0C00D	4.0				11.0		11.0
	LQW04AN4N0D00D							
	LQW04AN4N1C00D	4.1				11.0		11.0
	LQW04AN4N1D00D							
	LQW04AN4N2C00D	4.2				11.0		11.0
	LQW04AN4N2D00D							
	LQW04AN4N3C00D	4.3				11.0		11.0
	LQW04AN4N3D00D							
	LQW04AN4N4C00D	4.4		11.0	11.0			
	LQW04AN4N4D00D							
	LQW04AN4N5C00D	4.5		11.0	11.0			
	LQW04AN4N5D00D							
	LQW04AN4N6C00D	4.6		11.0	11.0			
	LQW04AN4N6D00D							
	LQW04AN4N7C00D	4.7		11.0	11.0			
	LQW04AN4N7D00D							
	LQW04AN4N8C00D	4.8		11.0	11.0			
	LQW04AN4N8D00D							
	LQW04AN4N9C00D	4.9		15	0.23	9.0	350	
	LQW04AN4N9D00D							
	LQW04AN5N0C00D	5.0		15	0.23	9.0	350	
	LQW04AN5N0D00D							
	LQW04AN5N1C00D	5.1		20	0.12	10.0	470	
	LQW04AN5N1D00D							
	LQW04AN5N2C00D	5.2		20	0.12	10.0	470	
	LQW04AN5N2D00D							
	LQW04AN5N3C00D	5.3		20	0.19	9.0	390	
	LQW04AN5N3D00D							
	LQW04AN5N4C00D	5.4		20	0.12	9.0	470	
	LQW04AN5N4D00D							
	LQW04AN5N5C00D	5.5		20	0.12	9.0	470	
	LQW04AN5N5D00D							
	LQW04AN5N6C00D	5.6		20	0.12	9.0	470	
	LQW04AN5N6D00D							
	LQW04AN5N7C00D	5.7		20	0.12	9.0	470	
	LQW04AN5N7D00D							
	LQW04AN5N8C00D	5.8		20	0.19	9.0	390	
	LQW04AN5N8D00D							
	LQW04AN5N9C00D	5.9		20	0.19	9.0	390	
	LQW04AN5N9D00D							
	LQW04AN6N0C00D	6.0		20	0.19	9.0	390	
	LQW04AN6N0D00D							

C:±0.2nH
D:±0.5nH

Customer Part Number	MURATA Part Number	Inductance		Q (min.)	DC Resistance (Ω max.)	Self Resonant Frequency (MHz min.)	Rated Current (mA)
		(nH)	Tolerance				
	LQW04AN6N1C00D	6.1					
	LQW04AN6N1D00D						
	LQW04AN6N2C00D	6.2					
	LQW04AN6N2D00D						
	LQW04AN6N3C00D	6.3					
	LQW04AN6N3D00D						
	LQW04AN6N4C00D	6.4			0.19	9.0	390
	LQW04AN6N4D00D						
	LQW04AN6N5C00D	6.5					
	LQW04AN6N5D00D						
	LQW04AN6N6C00D	6.6					
	LQW04AN6N6D00D						
	LQW04AN6N7C00D	6.7					
	LQW04AN6N7D00D						
	LQW04AN6N8C00D	6.8					
	LQW04AN6N8D00D						
	LQW04AN6N9C00D	6.9					
	LQW04AN6N9D00D						
	LQW04AN7N0C00D	7.0					
	LQW04AN7N0D00D						
	LQW04AN7N1C00D	7.1					
	LQW04AN7N1D00D						
	LQW04AN7N2C00D	7.2			0.14		440
	LQW04AN7N2D00D						
	LQW04AN7N3C00D	7.3		20			
	LQW04AN7N3D00D						
	LQW04AN7N4C00D	7.4					
	LQW04AN7N4D00D						
	LQW04AN7N5C00D	7.5					
	LQW04AN7N5D00D						
	LQW04AN7N6C00D	7.6				8.0	
	LQW04AN7N6D00D						
	LQW04AN7N7C00D	7.7					
	LQW04AN7N7D00D						
	LQW04AN7N8C00D	7.8					
	LQW04AN7N8D00D						
	LQW04AN7N9C00D	7.9					
	LQW04AN7N9D00D						
	LQW04AN8N0C00D	8.0			0.23		350
	LQW04AN8N0D00D						
	LQW04AN8N1C00D	8.1					
	LQW04AN8N1D00D						
	LQW04AN8N2C00D	8.2					
	LQW04AN8N2D00D						
	LQW04AN8N3C00D	8.3					
	LQW04AN8N3D00D						
	LQW04AN8N4C00D	8.4					
	LQW04AN8N4D00D						
	LQW04AN8N5C00D	8.5					
	LQW04AN8N5D00D						
	LQW04AN8N6C00D	8.6					
	LQW04AN8N6D00D						
	LQW04AN8N7C00D	8.7		15	0.33	7.0	290
	LQW04AN8N7D00D						
	LQW04AN8N8C00D	8.8					
	LQW04AN8N8D00D						

Customer Part Number	MURATA Part Number	Inductance		Q (min.)	DC Resistance (Ω max.)	Self Resonant Frequency (MHz min.)	Rated Current (mA)
		(nH)	Tolerance				
	LQW04AN8N9C00D	8.9	C: \pm 0.2nH D: \pm 0.5nH	20	0.26	7.0	330
	LQW04AN8N9D00D						
	LQW04AN9N0C00D	9.0					
	LQW04AN9N0D00D						
	LQW04AN9N1C00D	9.1					
	LQW04AN9N1D00D						
	LQW04AN9N2C00D	9.2					
	LQW04AN9N2D00D						
	LQW04AN9N3C00D	9.3					
	LQW04AN9N3D00D						
	LQW04AN9N4C00D	9.4					
	LQW04AN9N4D00D						
	LQW04AN9N5C00D	9.5					
	LQW04AN9N5D00D						
	LQW04AN9N6C00D	9.6					
	LQW04AN9N6D00D						
	LQW04AN9N7C00D	9.7					
	LQW04AN9N7D00D						
	LQW04AN9N8C00D	9.8					
	LQW04AN9N8D00D						
	LQW04AN9N9C00D	9.9					
	LQW04AN9N9D00D						
	LQW04AN10NH00D	10	H: \pm 3% J: \pm 5%	15	0.26	5.0	330
	LQW04AN10NJ00D						
	LQW04AN11NH00D	11					
	LQW04AN11NJ00D						
	LQW04AN12NH00D	12					
	LQW04AN12NJ00D						
	LQW04AN13NH00D	13					
	LQW04AN13NJ00D						
	LQW04AN14NH00D	14					
	LQW04AN14NJ00D						
	LQW04AN15NH00D	15					
	LQW04AN15NJ00D						
	LQW04AN16NH00D	16					
	LQW04AN16NJ00D						
	LQW04AN18NH00D	18					
	LQW04AN18NJ00D						
	LQW04AN19NH00D	19					
	LQW04AN19NJ00D						
	LQW04AN20NH00D	20					
	LQW04AN20NJ00D						
	LQW04AN22NH00D	22					
	LQW04AN22NJ00D						
	LQW04AN23NH00D	23					
	LQW04AN23NJ00D						
	LQW04AN24NH00D	24					
	LQW04AN24NJ00D						
	LQW04AN25NH00D	25					
	LQW04AN25NJ00D						
	LQW04AN27NH00D	27					
	LQW04AN27NJ00D						
	LQW04AN33NH00D	33					
	LQW04AN33NJ00D						
					1.11		140

4. Testing Conditions

《Unless otherwise specified》

Temperature : Ordinary Temperature / 15°C to 35°C
Humidity : Ordinary Humidity / 25%(RH) to 85%(RH)

《In case of doubt》

Temperature : 20°C±2°C
Humidity : 60%(RH) to 70%(RH)
Atmospheric Pressure : 86kPa to 106 kPa

5. Appearance and Dimensions

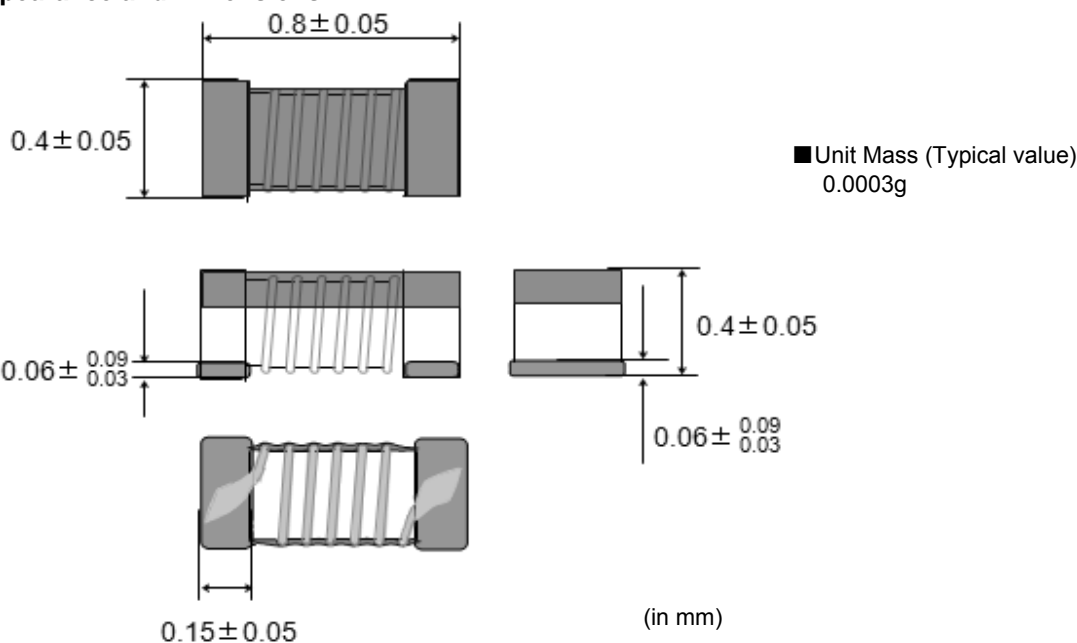

6. Electrical Performance

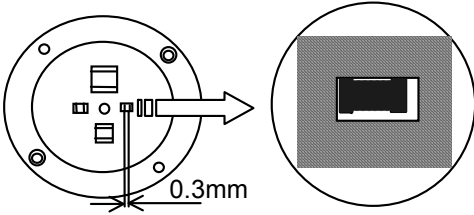
No.	Item	Specification	Test Method
6.1	Inductance	Inductance shall meet item 3.	Measuring Equipment : KEYSIGHT E4991A or equivalent Measuring Frequency : <Inductance> 100MHz <Q> 250MHz Measuring Condition : Test signal level / about 0dBm Electrical length/ 10mm Measuring Fixture : KEYSIGHT 16197A Position coil under test as shown in below and contact coil with each terminal by adding weight.
6.2	Q	Q shall meet item 3.	 <p>0.3mm</p> <p>Measuring Method : See the endnote. <Electrical Performance : Measuring Method of Inductance/Q></p>
6.3	DC Resistance	DC Resistance shall meet item 3.	Measuring Equipment : Digital multi meter
6.4	Self Resonant Frequency(S.R.F)	S.R.F shall meet item 3.	Measuring Equipment : KEYSIGHT 8720C or equivalent
6.5	Rated Current	Self temperature rise shall be limited to 20°C max.	The rated current is applied.

7. Mechanical Performance

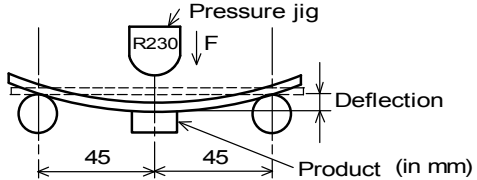
No.	Item	Specification	Test Method
7.1	Bending Test	Chip coil shall not be damaged after tested as test method.	<p>Substrate : Glass-epoxy substrate (100mm×40mm×0.8mm) Speed of Applying Force : 1mm / s Deflection : 2mm Hold Duration : 5s</p> 
7.2	Vibration		<p>Oscillation Frequency : 10Hz~55Hz~10Hz for 1 min Total Amplitude : 1.5mm Testing Time : A period of 2 hours in each of 3 mutually perpendicular directions. (Total 6hours)</p>
7.3	Solderability	The wetting area of the electrode shall be at least 90% covered with new solder coating.	<p>Flux : Ethanol solution of rosin,25(wt)% Includes activator equivalent to 0.06(wt)% chlorine.(immersed for 5s to 10s) Solder : Sn-3.0Ag-0.5Cu Pre-Heating : 150°C±10°C / 60s to 90s Solder Temperature : 240°C±5°C Immersion Time : 4s±1s</p>
7.4	Resistance to Soldering Heat	Appearance : No damage Inductance Change : within ±5%	<p>Flux : Ethanol solution of rosin,25(wt)% Includes activator equivalent to 0.06(wt)% Chlorine.(immersed for 5s to 10s) Solder : Sn-3.0Ag-0.5Cu Pre-Heating : 150°C±10°C / 60s to 90s Solder Temperature : 270°C±5°C Immersion Time : 5s±1s Then measured after exposure in the room condition for 24h±2h.</p>

8. Environmental Performance

It shall be soldered on the substrate.

No.	Item	Specification	Test Method
8.1	Heat Resistance	Appearance : No damage Inductance Change : within ±5% Q Change : within ±20%	Temperature : 125°C±2°C Time : 1000h (+48h,0h) Then measured after exposure in the room condition for 24h±2h.
8.2	Cold Resistance		Temperature : -55°C±2°C Time : 1000h (+48h,-0h) Then measured after exposure in the room condition for 24±2 h.
8.3	Humidity		Temperature : 70°C±2°C Humidity : 90%(RH) to 95%(RH) Time : 1000h (+48h,-0h) Then measured after exposure in the room condition for 24h±2h.
8.4	Temperature Cycle		1 cycle : 1 step : -55°C±2°C / 30min±3 min 2 step : Ordinary temp. / 10min to 15 min 3 step : +125°C±2°C / 30min±3 min 4 step : Ordinary temp. / 10min to 15 min Total of 10 cycles Then measured after exposure in the room condition for 24h±2h.

9. Specification of Packaging

9.1 Appearance and Dimensions of paper tape (8mm-wide)

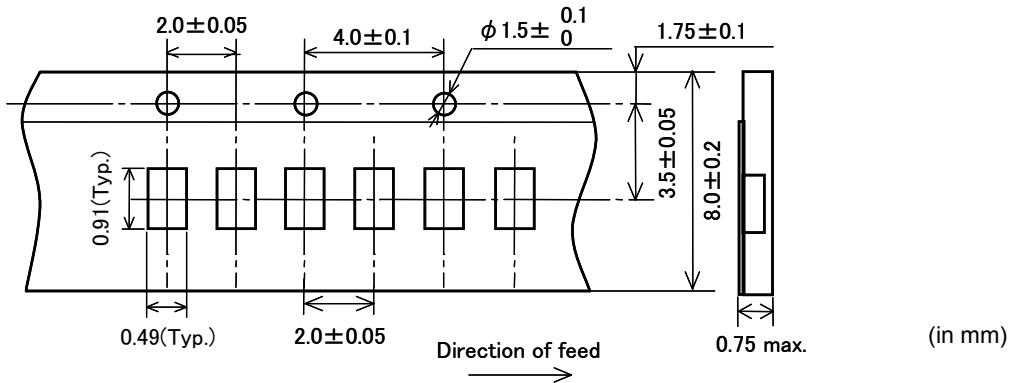

9.2 Specification of Taping

- (1) Packing quantity (standard quantity)
10,000 pcs. / reel
- (2) Packing Method
Products shall be packed in the cavity of the base tape and sealed by Cover tape.
- (3) Sprocket hole
The sprocket holes are to the right as the tape is pulled toward the user.
- (4) Spliced point
Base tape and Cover tape has no spliced point.
- (5) Missing components number
Missing components number within 0.1% of the number per reel or 1 pc., whichever is greater, and are not continuous. The Specified quantity per reel is kept.

9.3 Pull Strength

Cover tape	5N min.
------------	---------

9.4 Peeling off force of cover tape

Speed of Peeling off	300mm/min
Peeling off force	0.1N to 0.6N (minimum value is typical)

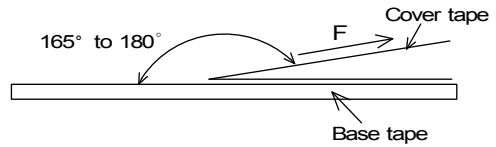

9.5 Dimensions of Leader-tape, Trailer and Reel

There shall be leader-tape (cover tape and empty tape) and trailer-tape (empty tape) as follows.

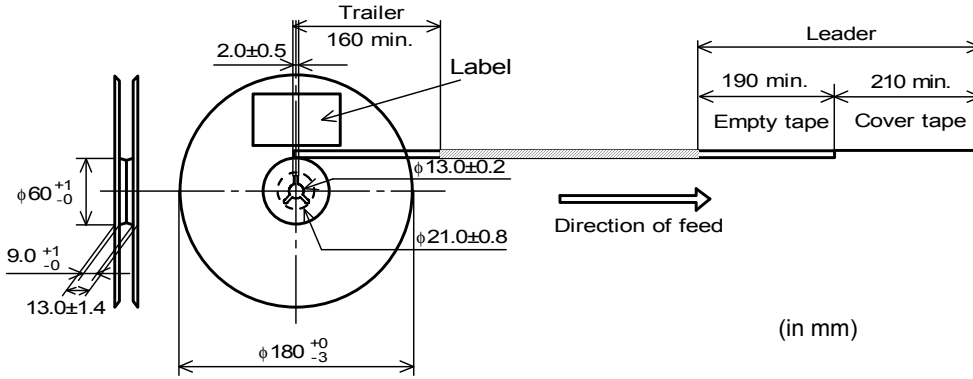

(in mm)

9.6 Marking for reel

Customer part number, MURATA part number, Inspection number(*1), RoHS marking(*2), Quantity etc ...

*1) <Expression of Inspection No.> □□ ○○○○ ×××

- (1) Factory Code
- (2) Date First digit : Year / Last digit of year
- Second digit : Month / Jan. to Sep. → 1 to 9, Oct. to Dec. → O, N, D
- Third, Fourth digit : Day
- (3) Serial No.

*2) « Expression of RoHS marking » ROHS - Y (Δ)

- (1) RoHS regulation conformity
- (2) MURATA classification number

9.7 Marking for Outside package (corrugated paper box)

Customer name, Purchasing order number, Customer part number, MURATA part number, RoHS Marking (*2) , Quantity, etc ...

9.8. Specification of Outer Case

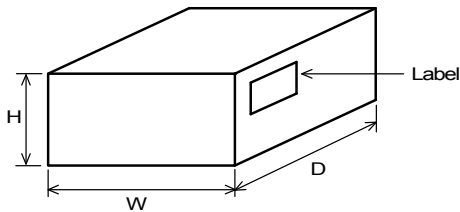

Outer Case Dimensions (mm)			Standard Reel Quantity in Outer Case (Reel)
W	D	H	
186	186	93	5

* Above Outer Case size is typical. It depends on a quantity of an order.

10. ⚠ Caution

Limitation of Applications

Please contact us before using our products for the applications listed below which require especially high reliability for the prevention of defects which might directly cause damage to the third party's life, body or property.

- (1) Aircraft equipment
- (2) Aerospace equipment
- (3) Undersea equipment
- (4) Power plant control equipment
- (5) Medical equipment
- (6) Transportation equipment (vehicles, trains, ships, etc.)
- (7) Traffic signal equipment
- (8) Disaster prevention / crime prevention equipment
- (9) Data-processing equipment
- (10) Applications of similar complexity and /or reliability requirements to the applications listed in the above

11. Notice

Products can only be soldered with reflow.
 This product is designed for solder mounting.
 Please consult us in advance for applying other mounting method such as conductive adhesive.

11.1 Land pattern designing

Recommended land patterns for reflow soldering are as follows:
 These have been designed for Electric characteristics and solderability.
 Please follow the recommended patterns. Otherwise, their performance which includes electrical performance or solderability may be affected, or result to "position shift" in soldering process.

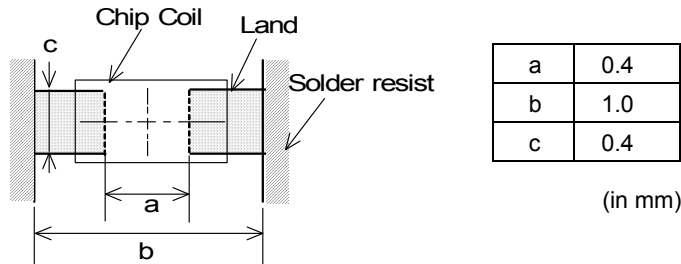

11.2 Flux, Solder

- Use rosin-based flux.
 Includes middle activator equivalent to 0.06(wt)% to 0.1(wt) % Chlorine.
 Don't use highly acidic flux with halide content exceeding 0.2(wt) % (chlorine conversion value).
 Don't use water-soluble flux.
- Use Sn-3.0Ag-0.5Cu solder.
- Standard thickness of solder paste : 80 μ m to 100 μ m.

11.3 Reflow soldering conditions

- Pre-heating should be in such a way that the temperature difference between solder and product surface is limited to 150°C max. Cooling into solvent after soldering also should be in such a way that the temperature difference is limited to 100°C max.
 Insufficient pre-heating may cause cracks on the product, resulting in the deterioration of products quality.
- Standard soldering profile and the limit soldering profile is as follows.
 The excessive limit soldering conditions may cause leaching of the electrode and / or resulting in the deterioration of product quality.
- Reflow soldering profile

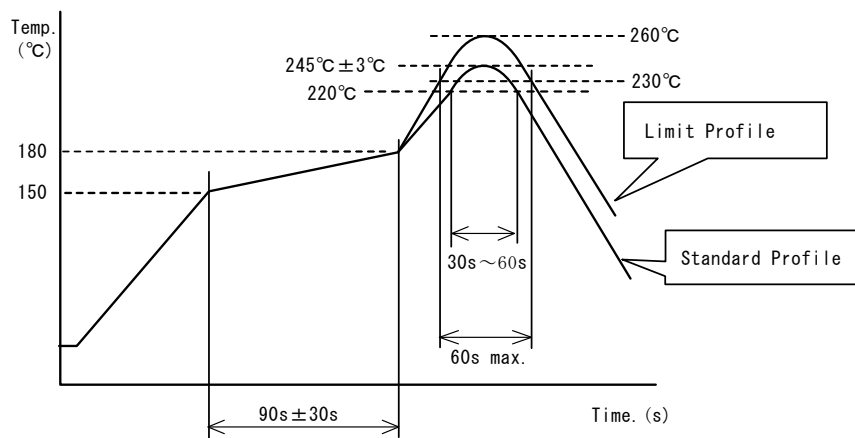

	Standard Profile	Limit Profile
Pre-heating	150°C~180°C , 90s±30s	
Heating	above 220°C, 30s~60s	above 230°C, 60s max.
Peak temperature	245°C±3°C	260°C, 10s
Cycle of reflow	2 times	

11.4 Solder Volume

- Solder shall be used not to be exceed the upper limits as shown below.
- Accordingly increasing the solder volume, the mechanical stress to Chip is also increased. Exceeding solder volume may cause the failure of mechanical or electrical performance.

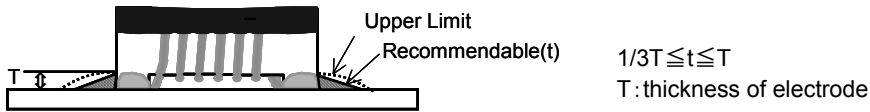

11.5 Product's location

The following shall be considered when designing and laying out P.C.B.'s.

- (1) P.C.B. shall be designed so that products are not subject to the mechanical stress due to warping the board.

[Products direction]

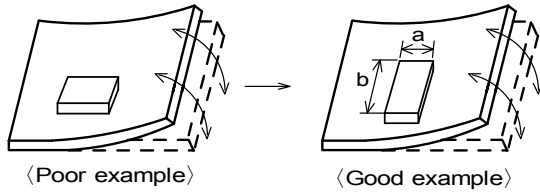

Products shall be located in the sideways direction (Length:a < b) to the mechanical stress.

- (2) Components location on P.C.B. separation.

It is effective to implement the following measures, to reduce stress in separating the board. It is best to implement all of the following three measures; however, implement as many measures as possible to reduce stress.

Contents of Measures	Stress Level
(1) Turn the mounting direction of the component parallel to the board separation surface.	A > D *1
(2) Add slits in the board separation part.	A > B
(3) Keep the mounting position of the component away from the board separation surface.	A > C

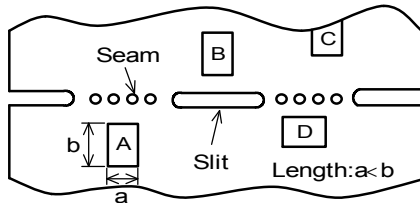

*1 A > D is valid when stress is added vertically to the perforation as with Hand Separation. If a Cutting Disc is used, stress will be diagonal to the PCB, therefore A > D is invalid.

- (3) Mounting Components Near Screw Holes

When a component is mounted near a screw hole, it may be affected by the board deflection that occurs during the tightening of the screw. Mount the component in a position as far away from the screw holes as possible.

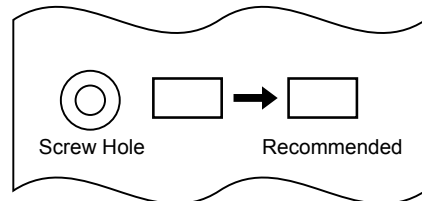

11.6 Cleaning Conditions

Products shall be cleaned on the following conditions.

- (1) Cleaning temperature shall be limited to 60°C max.(40°C max for IPA)
- (2) Ultrasonic cleaning shall comply with the following conditions with avoiding the resonance phenomenon at the mounted products and P.C.B.
 Power : 20 W / l max. Frequency : 28kHz to 40kHz Time : 5 min max.
- (3) Cleaner
 1. Alcohol type cleaner
Isopropyl alcohol (IPA)
 2. Aqueous agent
PINE ALPHA ST-100S
- (4) There shall be no residual flux and residual cleaner after cleaning.
 In the case of using aqueous agent, products shall be dried completely after rinse with de-ionized water in order to remove the cleaner.
- (5) Other cleaning Please contact us.

11.7 Resin coating

The inductance value may change due to high cure-stress of resin to be used for coating/molding products.

An open circuit issue may occur by mechanical stress caused by the resin, amount/cured shape of resin, or operating condition etc. Some resin contains some impurities or chloride possible to generate chlorine by hydrolysis under some operating condition may cause corrosion of wire of coil, leading to open circuit.

So, please pay your careful attention when you select resin in case of coating/molding the products with the resin. Prior to use the coating resin, please make sure no reliability issue is observed by evaluating products mounted on your board.

11.8 Caution for use

- Sharp material such as a pair of tweezers or other material such as bristles of cleaning brush , shall not be touched to the winding portion to prevent the breaking of wire.
- Mechanical shock should not be applied to the products mounted on the board to prevent the breaking of the core.

11.9 Notice of product handling at mounting

In some mounting machines,when picking up components support pin pushes up the components from the bottom of base tape. In this case, please remove the support pin. The support pin may damage the components and break wire. In rare case ,the laser recognition can not recognize this component. Please contact us when you use laser recognition. (There is no problem with the permeation and reflection type.)

11.10 Handling of a substrate

After mounting products on a substrate, do not apply any stress to the product caused by bending or twisting to the substrate when cropping the substrate, inserting and removing a connector from the substrate or tightening screw to the substrate.

Excessive mechanical stress may cause cracking in the product.

Bending

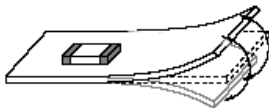

Twisting

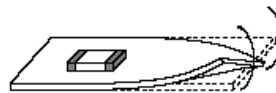
**11.11 Storage and Handling Requirements****(1) Storage period**

Use the products within 12 months after delivered.

Solderability should be checked if this period is exceeded.

(2) Storage conditions

- Products should be stored in the warehouse on the following conditions.

Temperature : -10°C to 40°C

Humidity : 15% to 85% relative humidity No rapid change on temperature and humidity

- Don't keep products in corrosive gases such as sulfur, chlorine gas or acid, or it may cause oxidization of electrode, resulting in poor solderability.
- Products should not be stored on bulk packaging condition to prevent the chipping of the core and the breaking of winding wire caused by the collision between the products.
- Products should be stored on the palette for the prevention of the influence from humidity, dust and so on.
- Products should be stored in the warehouse without heat shock, vibration, direct sunlight and so on.

(3) Handling Condition

Care should be taken when transporting or handling product to avoid excessive vibration or mechanical shock.

12. ⚠ Note

(1) Please make sure that your product has been evaluated in view of your specifications with our product being mounted to your product.

(2) You are requested not to use our product deviating from the agreed specifications.

(3) The contents of this reference specification are subject to change without advance notice.

Please approve our product specifications or transact the approval sheet for product specifications before ordering.

<Electrical Performance:Measuring Method of Inductance/Q>

(1) Residual elements and stray elements of test fixture can be described by F-parameter shown in following.

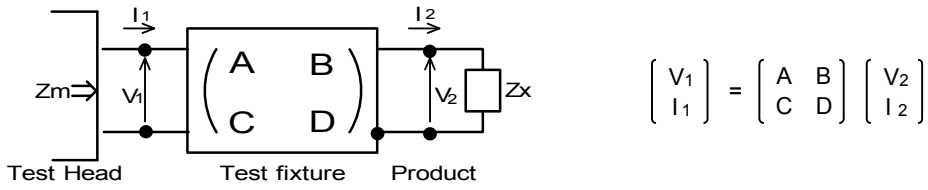

(2) The impedance of chip coil Zx and measured value Zm can be described by input/output current/voltage.

$$Z_m = \frac{V_1}{I_1}, \quad Z_x = \frac{V_2}{I_2}$$

(3) Thus, the relation between Zx and Zm is following;

$$Z_x = \alpha \frac{Z_m - \beta}{1 - Z_m \Gamma} \quad \text{where, } \alpha = D / A = 1$$

$$\beta = B / D = Z_{sm} - (1 - Y_{om} Z_{sm}) Z_{ss}$$

$$\Gamma = C / A = Y_{om}$$

- Zsm : measured impedance of short chip
- Zss : residual impedance of short chip (0.464nH)
- Yom : measured admittance when opening the fixture

(4) Lx and Qx shall be calculated with the following equation.

$$L_x = \frac{\text{Im}(Z_x)}{2\pi f}, \quad Q_x = \frac{\text{Im}(Z_x)}{\text{Re}(Z_x)}$$

Lx : Inductance of chip coil
Qx : Q of chip coil
f : Measuring frequency