

LQH3NPN470NJ0#

"#" indicates a package specification code.



Last Time Buy Date: 31 Mar 2018 Date of discontinuation: 30 Apr 2018

< List of part numbers with package codes >
LQH3NPN470NJ0L , LQH3NPN470NJ0K

Shape

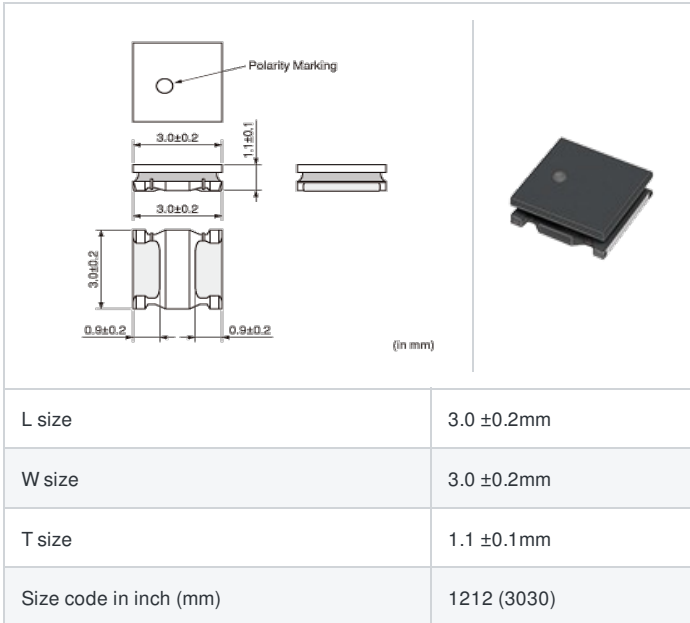

Notes

When applied Rated current to the Products, Inductance will be within ±30% of nominal Inductance value.
When applied Rated current to the Products, temperature rise caused by self-generated heat shall be limited to 40°C max.
Keep the temperature (ambient temperature plus self-generation of heat) under 125°C.

References

Packaging code	Specifications	Minimum quantity
L	φ180mm Embossed taping	1000
K	φ330mm Embossed taping	5000

Mass (Typ.)	
1 piece	0.045g

Specifications

Inductance	47μH ±30%
Inductance test frequency	1MHz
Rated current (I _{sat}) (Based on Inductance change)	200mA
Rated current (I _{temp}) (Based on Temperature rise)	350mA
Max. of DC resistance	1.56Ω
Avg. of DC resistance	1.30Ω ±20%
Self resonance frequency (min.)	15MHz
Operating temperature range (Self-temperature rise is included)	-40~125°C
Operating temperature range (Self-temperature rise is not included)	-40~85°C
Class of magnetic shield	Magnetic Resin
Series	LQH3NPN_J0

Attention

- This datasheet is downloaded from the website of Murata Manufacturing Co., Ltd. Therefore, it's specifications are subject to change or our products in it may be discontinued without advance notice. Please check with our sales representatives or product engineers before ordering.
- This datasheet has only typical specifications because there is no space for detailed specifications. Therefore, please review our product specifications or consult the approval sheet for product specifications before ordering.

Chart of characteristic data (The charts below may show another part number which shares its characteristics.)

▪ Inductance-Frequency characteristics (Typ.)

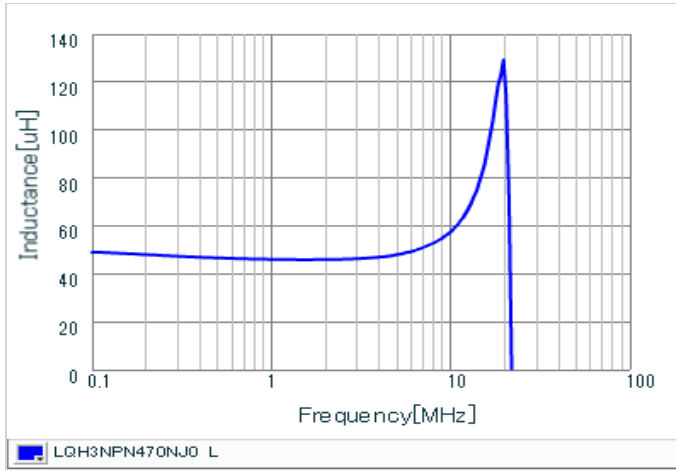

▪ Inductance-Current characteristics (Typ.)

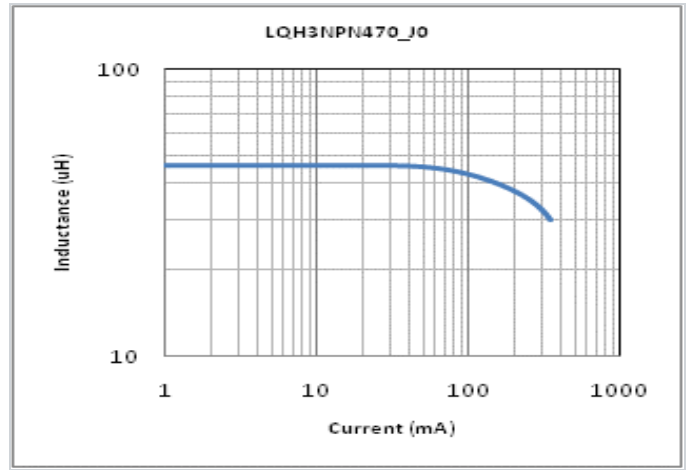

▪ Temperature rise characteristics (Typ.)

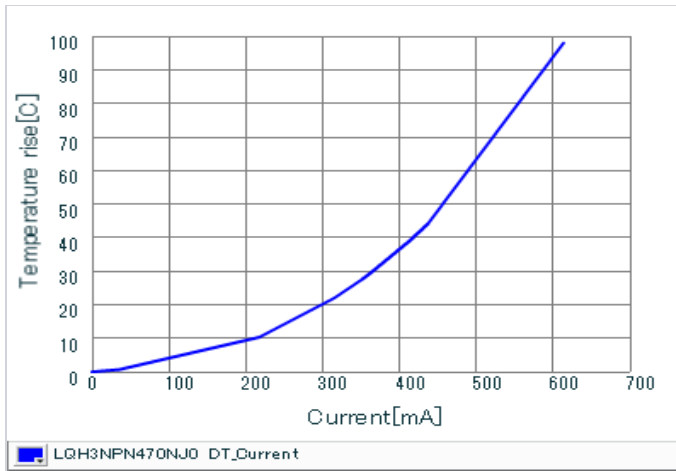

⚠ Attention

- 1.This datasheet is downloaded from the website of Murata Manufacturing Co., Ltd. Therefore, it's specifications are subject to change or our products in it may be discontinued without advance notice. Please check with our sales representatives or product engineers before ordering.
- 2.This datasheet has only typical specifications because there is no space for detailed specifications. Therefore, please review our product specifications or consult the approval sheet for product specifications before ordering.