

**CHIP COIL (CHIP INDUCTORS) LQG15WH□□□□02D**  
**Murata Standard Reference Specification [AEC-Q200]**

**1.Scope**

This reference specification applies to LQG15WH series Chip Coil (Chip Inductors) for Automotive Electronics based on AEC-Q200.

**2.Part Numbering**

(ex) LQ G 15 W H 1N0 S 0 2 D  
 Product ID Struture Dimension Applications Category Inductance Tolerance Features Electrode Pakaging  
 (L×W) and for Automotive Characteristics Electronics D:Taping

**3.Rating**

- Operating Temperature Range. -55°C to +125°C
- Storage Temperature Range. -55°C to +125°C

Customer Part Number	MURATA Part Number	Inductance (nH)	Tolerance	Q (min.)	DC Resistance (Ω max.)	Self Resonant Frequency (MHz min.)	Rated Current (mA)	ESD Rank 1C:1kV										
		(*1)(refer to below comment)																
	LQG15WH0N7B02D	0.7	B:±0.1nH C:±0.2nH S:±0.3nH	-	0.03	15000	1200	1C										
	LQG15WH0N7C02D																	
	LQG15WH0N7S02D																	
	LQG15WH0N8B02D																	
	LQG15WH0N8C02D																	
	LQG15WH0N8S02D																	
	LQG15WH0N9B02D	0.8				B:±0.1nH C:±0.2nH S:±0.3nH	-		0.03	15000	1200	1C						
	LQG15WH0N9C02D																	
	LQG15WH0N9S02D																	
	LQG15WH1N0B02D																	
	LQG15WH1N0C02D																	
	LQG15WH1N0S02D																	
	LQG15WH1N1B02D	0.9								B:±0.1nH C:±0.2nH S:±0.3nH	-		0.03	14000	1200	1C		
	LQG15WH1N1C02D																	
	LQG15WH1N1S02D																	
	LQG15WH1N2B02D																	
	LQG15WH1N2C02D																	
	LQG15WH1N2S02D																	
	LQG15WH1N3B02D	1.0	B:±0.1nH C:±0.2nH S:±0.3nH	-	0.03			13000						1200	1C			
	LQG15WH1N3C02D																	
	LQG15WH1N3S02D																	
	LQG15WH1N4B02D																	
	LQG15WH1N4C02D																	
	LQG15WH1N4S02D																	
	LQG15WH1N5B02D	1.1				B:±0.1nH C:±0.2nH S:±0.3nH	-	0.03	12000			1000		1C				
	LQG15WH1N5C02D																	
	LQG15WH1N5S02D																	
	LQG15WH1N6B02D																	
	LQG15WH1N6C02D																	
	LQG15WH1N6S02D																	
	LQG15WH1N7B02D	1.2							B:±0.1nH C:±0.2nH S:±0.3nH	23	0.04	10000	1000			1C		
	LQG15WH1N7C02D																	
	LQG15WH1N7S02D																	
	LQG15WH1N8B02D																	
	LQG15WH1N8C02D																	
	LQG15WH1N8S02D																	
	LQG15WH1N9B02D	1.3	B:±0.1nH C:±0.2nH S:±0.3nH	23	0.04							9000	1000		1C			
	LQG15WH1N9C02D																	
	LQG15WH1N9S02D																	
	LQG15WH1N9B02D	1.4				B:±0.1nH C:±0.2nH S:±0.3nH	23	0.05						8000			1000	1C
	LQG15WH1N9C02D																	
	LQG15WH1N9S02D																	

Customer Part Number	MURATA Part Number	Inductance (nH)	Tolerance	Q (min.)	DC Resistance ( $\Omega$ max.)	Self Resonant Frequency (MHz min.)	Rated Current (mA)	ESD Rank 1C:1kV	
	LQG15WH2N0B02D	2.0	B: $\pm 0.1$ nH C: $\pm 0.2$ nH S: $\pm 0.3$ nH	23	0.05	8000	1000	1C	
	LQG15WH2N0C02D								
	LQG15WH2N0S02D								
	LQG15WH2N1B02D	2.1			0.06				7000
	LQG15WH2N1C02D								
	LQG15WH2N1S02D								
	LQG15WH2N2B02D	2.2			0.07	6500			
	LQG15WH2N2C02D								
	LQG15WH2N2S02D								
	LQG15WH2N3B02D	2.3			0.06	900			
	LQG15WH2N3C02D								
	LQG15WH2N3S02D								
	LQG15WH2N4B02D	2.4			0.07	6000			
	LQG15WH2N4C02D								
	LQG15WH2N4S02D								
	LQG15WH2N5B02D	2.5			0.08	5500			
	LQG15WH2N5C02D								
	LQG15WH2N5S02D								
	LQG15WH2N6B02D	2.6			0.09	5000			
	LQG15WH2N6C02D								
	LQG15WH2N6S02D								
	LQG15WH2N7B02D	2.7			0.08	4500			
	LQG15WH2N7C02D								
	LQG15WH2N7S02D								
	LQG15WH2N8B02D	2.8	0.09	4000					
	LQG15WH2N8C02D								
	LQG15WH2N8S02D								
	LQG15WH2N9B02D	2.9	0.10	3500					
	LQG15WH2N9C02D								
	LQG15WH2N9S02D								
	LQG15WH3N0B02D	3.0	0.09	3000					
	LQG15WH3N0C02D								
	LQG15WH3N0S02D								
	LQG15WH3N1B02D	3.1	0.08	2500					
	LQG15WH3N1C02D								
	LQG15WH3N1S02D								
	LQG15WH3N2B02D	3.2	0.07	2000					
	LQG15WH3N2C02D								
	LQG15WH3N2S02D								
	LQG15WH3N3B02D	3.3	0.06	1500					
	LQG15WH3N3C02D								
	LQG15WH3N3S02D								
	LQG15WH3N4B02D	3.4	0.05	1000					
	LQG15WH3N4C02D								
	LQG15WH3N4S02D								
	LQG15WH3N5B02D	3.5	0.04	5800					
	LQG15WH3N5C02D								
	LQG15WH3N5S02D								
	LQG15WH3N6B02D	3.6	0.03	5500					
	LQG15WH3N6C02D								
	LQG15WH3N6S02D								
	LQG15WH3N7B02D	3.7	0.02	5000					
	LQG15WH3N7C02D								
	LQG15WH3N7S02D								
	LQG15WH3N8B02D	3.8	0.01	4500					
	LQG15WH3N8C02D								
	LQG15WH3N8S02D								

Customer Part Number	MURATA Part Number	Inductance (nH)	Tolerance	Q (min.)	DC Resistance ( $\Omega$ max.)	Self Resonant Frequency (MHz min.)	Rated Current (mA)	ESD Rank 1C:1kV
	LQG15WH3N9B02D							
	LQG15WH3N9C02D	3.9			0.09		900	
	LQG15WH3N9S02D							
	LQG15WH4N1B02D							
	LQG15WH4N1C02D	4.1						
	LQG15WH4N1S02D				0.10	5000		
	LQG15WH4N3B02D							
	LQG15WH4N3C02D	4.3						
	LQG15WH4N3S02D							
	LQG15WH4N7B02D							
	LQG15WH4N7C02D	4.7			0.11		800	
	LQG15WH4N7S02D							
	LQG15WH5N1B02D							
	LQG15WH5N1C02D	5.1			0.12	4500		
	LQG15WH5N1S02D							
	LQG15WH5N6B02D							
	LQG15WH5N6C02D	5.6						
	LQG15WH5N6S02D							
	LQG15WH5N8B02D							
	LQG15WH5N8C02D	5.8			0.13			
	LQG15WH5N8S02D							
	LQG15WH6N2B02D							
	LQG15WH6N2C02D	6.2					700	
	LQG15WH6N2S02D							
	LQG15WH6N8G02D							
	LQG15WH6N8H02D	6.8			0.14	4000		
	LQG15WH6N8J02D							
	LQG15WH7N3G02D							
	LQG15WH7N3H02D	7.3			0.17		600	
	LQG15WH7N3J02D							
	LQG15WH7N5G02D							
	LQG15WH7N5H02D	7.5						
	LQG15WH7N5J02D				0.16			
	LQG15WH8N2G02D							
	LQG15WH8N2H02D	8.2				3600		
	LQG15WH8N2J02D							
	LQG15WH8N7G02D							
	LQG15WH8N7H02D	8.7			0.17	3500	550	
	LQG15WH8N7J02D							
	LQG15WH9N1G02D							
	LQG15WH9N1H02D	9.1				3400		
	LQG15WH9N1J02D							
	LQG15WH9N5G02D							
	LQG15WH9N5H02D	9.5			0.21			
	LQG15WH9N5J02D					3300	500	
	LQG15WH10NG02D							
	LQG15WH10NH02D	10			0.19			
	LQG15WH10NJ02D							
	LQG15WH11NG02D							
	LQG15WH11NH02D	11			0.22	3000		
	LQG15WH11NJ02D						450	
	LQG15WH12NG02D							
	LQG15WH12NH02D	12			0.24			
	LQG15WH12NJ02D					2800		
	LQG15WH13NG02D							
	LQG15WH13NH02D	13			0.26		400	
	LQG15WH13NJ02D							

Customer Part Number	MURATA Part Number	Inductance (nH)	Tolerance	Q (min.)	DC Resistance ( $\Omega$ max.)	Self Resonant Frequency (MHz min.)	Rated Current (mA)	ESD Rank 1C:1kV	
		(*1)(refer to below comment)							
	LQG15WH15NG02D	15	G: $\pm 2\%$ H: $\pm 3\%$ J: $\pm 5\%$	23	0.28	2300	400	1C	
	LQG15WH15NH02D								
	LQG15WH15NJ02D								
	LQG15WH16NG02D	16		20					
	LQG15WH16NH02D								
	LQG15WH16NJ02D								
	LQG15WH18NG02D	18		22					
	LQG15WH18NH02D								
	LQG15WH18NJ02D								
	LQG15WH19NG02D	19		20	0.8	2100	260		
	LQG15WH19NH02D								
	LQG15WH19NJ02D								
	LQG15WH20NG02D	20			1.1		2000		230
	LQG15WH20NH02D								
	LQG15WH20NJ02D								
	LQG15WH22NG02D	22	22		1.2	1700	220		
	LQG15WH22NH02D								
	LQG15WH22NJ02D								
	LQG15WH23NG02D	23			1.3	1600	190		
	LQG15WH23NH02D								
	LQG15WH23NJ02D								
	LQG15WH24NG02D	24				1.5	1400	180	
	LQG15WH24NH02D								
	LQG15WH24NJ02D								
	LQG15WH27NG02D	27		1.6			1300	180	
	LQG15WH27NH02D								
	LQG15WH27NJ02D								
	LQG15WH30NG02D	30					20	1700	220
	LQG15WH30NH02D								
	LQG15WH30NJ02D								
	LQG15WH33NG02D	33	1.8					1600	190
	LQG15WH33NH02D								
	LQG15WH33NJ02D								
	LQG15WH36NG02D	36			1.9			1400	180
	LQG15WH36NH02D								
	LQG15WH36NJ02D								
	LQG15WH39NG02D	39				22		1100	180
	LQG15WH39NH02D								
	LQG15WH39NJ02D								
	LQG15WH40NG02D	40		1.6				1300	180
	LQG15WH40NH02D								
	LQG15WH40NJ02D								
	LQG15WH43NG02D	43					1.8	1200	180
	LQG15WH43NH02D								
	LQG15WH43NJ02D								
	LQG15WH47NG02D	47	22					1100	180
	LQG15WH47NH02D								
	LQG15WH47NJ02D								
	LQG15WH51NG02D	51			1.8			1200	180
	LQG15WH51NH02D								
	LQG15WH51NJ02D								
	LQG15WH56NG02D	56				1.9		1100	180
	LQG15WH56NH02D								
	LQG15WH56NJ02D								
	LQG15WH62NG02D	62		22				1100	180
	LQG15WH62NH02D								
	LQG15WH62NJ02D								

Customer Part Number	MURATA Part Number	Inductance (nH)	Tolerance	Q (min.)	DC Resistance ( $\Omega$ max.)	Self Resonant Frequency (MHz min.)	Rated Current (mA)	ESD Rank 1C:1kV
	LQG15WH68NG02D	68	G: $\pm 2\%$ H: $\pm 3\%$ J: $\pm 5\%$	22	2.0	1100	160	1C
	LQG15WH68NH02D							
	LQG15WH68NJ02D							
	LQG15WH72NG02D							
	LQG15WH72NH02D							
	LQG15WH72NJ02D							
	LQG15WH75NG02D	72						
	LQG15WH75NH02D							
	LQG15WH75NJ02D							
	LQG15WH82NG02D	75						
	LQG15WH82NH02D							
	LQG15WH82NJ02D							
	LQG15WH82NG02D	82						
	LQG15WH82NH02D							
	LQG15WH82NJ02D							
	LQG15WH91NG02D	82						
	LQG15WH91NH02D							
	LQG15WH91NJ02D							
	LQG15WHR10G02D	91						
	LQG15WHR10H02D							
	LQG15WHR10J02D							
	LQG15WHR11G02D	100						
	LQG15WHR11H02D							
	LQG15WHR11J02D							
	LQG15WHR12G02D	110						
	LQG15WHR12H02D							
	LQG15WHR12J02D							
	LQG15WHR13G02D	120						
	LQG15WHR13H02D							
	LQG15WHR13J02D							
	LQG15WHR15G02D	130						
	LQG15WHR15H02D							
	LQG15WHR15J02D							
	LQG15WHR10G02D	150						
	LQG15WHR10H02D							
	LQG15WHR10J02D							
	LQG15WHR11G02D	110						
	LQG15WHR11H02D							
	LQG15WHR11J02D							
	LQG15WHR12G02D	120						
	LQG15WHR12H02D							
	LQG15WHR12J02D							
	LQG15WHR13G02D	130						
	LQG15WHR13H02D							
	LQG15WHR13J02D							
	LQG15WHR15G02D	150						
	LQG15WHR15H02D							
	LQG15WHR15J02D							

#### (\*1) Standard Testing Conditions

《Unless otherwise specified》

Temperature : Ordinary Temperature / 15°C to 35°C

Humidity : Ordinary Humidity / 25%(RH) to 85%(RH)

《In case of doubt》

Temperature : 20°C  $\pm$  2°C

Humidity : 60%(RH) to 70%(RH)

Atmospheric Pressure : 86kPa to 106 kPa

#### 4. Appearance and Dimensions

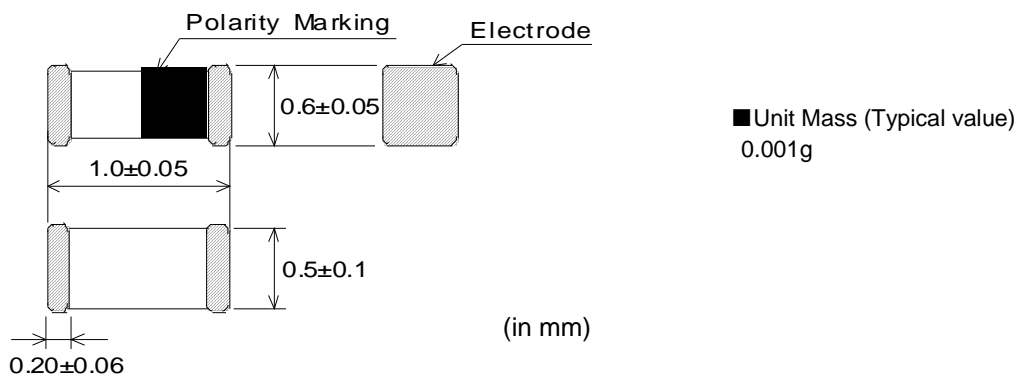

## 5.Electrical Performance

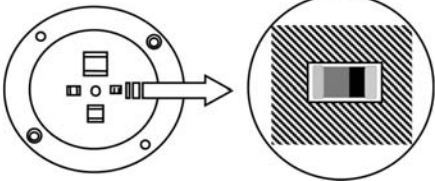
No.	Item	Specification	Test Method
5.1	Inductance	Inductance shall meet item 3.	Measuring Equipment: Keysight 4991A or equivalent Measuring Frequency:100MHz (Inductance) 250MHz (Q) Measuring Condition: Test signal level/about 0dBm Electrical length/10mm Weight/about 1N to 5N Measuring Fixture: Keysight 16197A Position coil under test as shown in below and contact coil with each terminal by adding weight. Polarity marking should be a topside, and polarity marking should be in the direction of the fixture for position of chip coil.
5.2	Q	Q shall meet item 3.	 Measuring Method: See P.11 [Electrical Performance: Measuring Method of Inductance/Q]
5.3	DC Resistance	DC Resistance shall meet item 3.	Measuring Equipment: Digital multi meter
5.4	Self Resonant Frequency(S.R.F)	S.R.F shall meet item 3.	Measuring Equipment: Keysight N5230A or equivalent
5.5	Rated Current	Self temperature rise shall be limited to 25°C max.	The allowable current is applied.

## 6.Q200 Requirement

## 6.1.Performance (based on Table 5 for Magnetics(Inductors / Transformer)

## AEC-Q200 Rev.D issued June 1. 2010

AEC-Q200			Murata Specification / Deviation				
No	Stress	Test Method					
3	High Temperature Exposure	1000hours at 125 deg C Set for 24hours at room temperature, then measured.	Meet Table A after testing. Table A <table border="1"> <tr> <td>Appearance</td> <td>No damage</td> </tr> <tr> <td>Inductance Change (at 100MHz)</td> <td>Within <math>\pm 10\%</math></td> </tr> </table>	Appearance	No damage	Inductance Change (at 100MHz)	Within $\pm 10\%$
Appearance	No damage						
Inductance Change (at 100MHz)	Within $\pm 10\%$						
4	Temperature Cycling	1000cycles -40 deg C to +125 deg C Set for 24hours at room temperature, then measured.	Meet Table A after testing.				
7	Biased Humidity	1000hours at 85 deg C, 85%RH unpowered.	Meet Table A after testing.				
8	Operational Life	Apply 125 deg C 1000hours Set for 24hours at room temperature, then measured	Meet Table A after testing.				
9	External Visual	Visual inspection	No abnormalities				
10	Physical Dimension	Meet ITEM 4 (Style and Dimensions)	No defects				
12	Resistance to Solvents	Per MIL-STD-202 Method 215	Not Applicable				
13	Mechanical Shock	Per MIL-STD-202 Method 213 Condition C : 100g's(0.98N), 6ms, Half sine, 12.3ft/s	Meet Table A after testing.				

AEC-Q200			Murata Specification / Deviation						
No	Stress	Test Method							
14	Vibration	5g's(0.049N) for 20 minutes, 12cycles each of 3 orientations Test from 10-2000Hz.	Meet Table A after testing.						
15	Resistance to Soldering Heat	No-heating Solder temperature 260C+/-5 deg C Immersion time 10s	Meet Table A after testing. Pre-heating 150C +/-10 deg C, 60s to 90s						
17	ESD	Per AEC-Q200-002	ESD Rank: refer to the Item3 (Rating). Meet Table A after testing						
18	Solderbilty	Per J-STD-002	Method b : Not Applicable 90% of the terminations is to be soldered.						
19	Electrical Characterization	Measured : Inductance	No defects						
20	Flammability	Per UL-94	Not Applicable						
21	Board Flex	Epoxy-PCB(1.6mm) Deflection 2mm(min) Holding time 60s	Meet Table B after testing. <table border="1"> <thead> <tr> <th colspan="2">Table B</th> </tr> </thead> <tbody> <tr> <td>Appearance</td> <td>No damage</td> </tr> <tr> <td>DC resistance Change</td> <td>Within ±10%</td> </tr> </tbody> </table>	Table B		Appearance	No damage	DC resistance Change	Within ±10%
Table B									
Appearance	No damage								
DC resistance Change	Within ±10%								
22	Terminal Strength	Per AEC-Q200-006 A force of 17.7N for 60s	Murata Deviation Request: 5N No defects						

## 7.Specification of Packaging

### 7.1 Appearance and Dimensions of paper tape (8mm-wide)

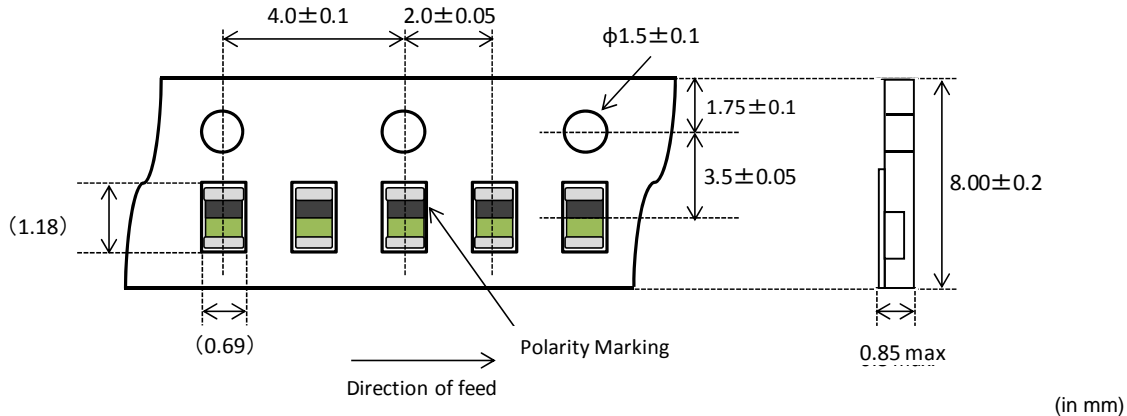

### 7.2 Specification of Taping

- (1) Packing quantity (standard quantity)  
10,000 pcs. / reel
- (2) Packing Method  
Products shall be packed in the cavity of the base tape and sealed by top tape.
- (3) Sprocket hole  
The sprocket holes are to the right as the tape is pulled toward the user.
- (4) Spliced point  
Base tape and Top tape has no spliced point.
- (5) Missing components number  
Missing components number within 0.1 % of the number per reel or 1 pc., whichever is greater, and are not continuous. The Specified quantity per reel is kept.

### 7.3 Pull Strength

Top tape	5N min.
----------	---------

**7.4 Peeling off force of cover tape**

Speed of Peeling off	300mm/min
Peeling off force	0.1N to 0.6N (minimum value is typical)

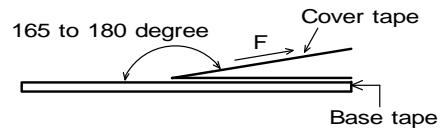

**7.5 Dimensions of Leader-tape,Trailer and Reel**

There shall be leader-tape ( top tape and empty tape) and trailer-tape (empty tape) as follows.

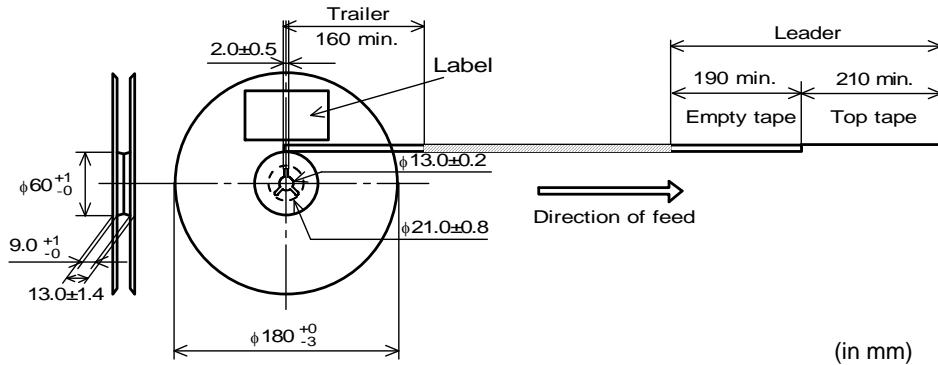

**7.6 Marking for reel**

Customer part number, MURATA part number, Inspection number(\*1) ,RoHS Marking(\*2), Quantity etc ...

\*1) <Expression of Inspection No.>

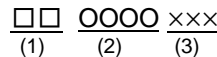

- (1) Factory Code
- (2) Date      First digit : Year / Last digit of year  
Second digit: Month / Jan. to Sep. → 1 to 9, Oct. to Dec. → O, N, D  
Third, Fourth digi : Day
- (3) Serial No.

\*2) <Expression of RoHS Marking>

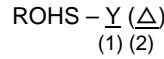

- (1) RoHS regulation conformity parts.
- (2) MURATA classification number

**7.7 Marking for Outside package (corrugated paper box)**

Customer name, Purchasing order number, Customer part number, MURATA part number, RoHS Marking(\*2) ,Quantity, etc ...

**7.8. Specification of Outer Case**

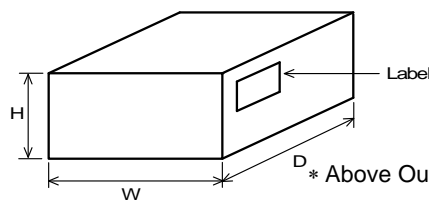

Outer Case Dimensions (mm)			Standard Reel Quantity in Outer Case (Reel)
W	D	H	
186	186	93	5

\* Above Outer Case size is typical. It depends on a quantity of an order.

**8. ⚠ Caution**

**8.1 Caution(Rating)**

Do not exceed maximum rated current of the product. Thermal stress may be transmitted to the product and short/open circuit of the product or falling off the product may be occurred.

**8.2 Fail-safe**

Be sure to provide an appropriate fail-safe function on your product to prevent a second damage that may be caused by the abnormal function or the failure of our product.



### 8.3 Limitation of Applications

Please contact us before using our products for the applications listed below which require especially high reliability for the prevention of defects which might directly cause damage to the third party's life, body or property.

- |                                   |  |
|-----------------------------------|--|
| (1) Aircraft equipment            | (6) Transportation equipment (trains, ships, etc.)   |
| (2) Aerospace equipment           | (7) Traffic signal equipment   |
| (3) Undersea equipment            | (8) Disaster prevention / crime prevention equipment   |
| (4) Power plant control equipment | (9) Data-processing equipment  |
| (5) Medical equipment             | (10) Applications of similar complexity and /or reliability requirements to the applications listed in the above |

## 9. Notice

Products can only be soldered with reflow.

This product is designed for solder mounting.

Please consult us in advance for applying other mounting method such as conductive adhesive.

### 9.1 Land pattern designing

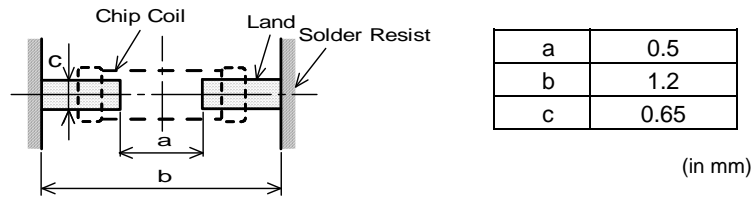

### 9.2 Flux, Solder

- Use rosin-based flux.
- Don't use highly acidic flux with halide content exceeding 0.2(wt)% (chlorine conversion value).
- Don't use water-soluble flux.
- Use Sn-3.0Ag-0.5Cu solder.
- Standard thickness of solder paste : 100  $\mu$ m to 150  $\mu$ m.

### 9.3 Reflow soldering conditions

- Inductance value may be changed a little due to the amount of solder.
- So, the chip coil shall be soldered by reflow so that the solder volume can be controlled.
- Pre-heating should be in such a way that the temperature difference between solder and product surface is limited to 150°C max. Cooling into solvent after soldering also should be in such a way that the temperature difference is limited to 100°C max.
- Insufficient pre-heating may cause cracks on the product, resulting in the deterioration of products quality.
- Standard soldering profile and the limit soldering profile is as follows.
- The excessive limit soldering conditions may cause leaching of the electrode and / or resulting in the deterioration of product quality.

- Reflow soldering profile

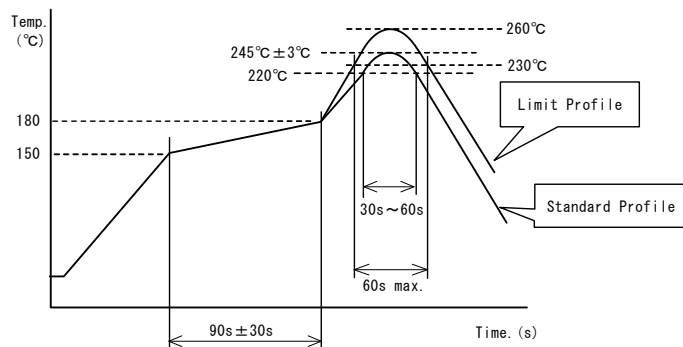

	Standard Profile	Limit Profile
Pre-heating	150°C ~ 180°C , 90s ± 30s	
Heating	above 220°C, 30s ~ 60s	above 230°C, 60s max.
Peak temperature	245°C ± 3°C	260°C, 10s
Cycle of reflow	2 times	

**9.4 Reworking with soldering iron**

The following conditions must be strictly followed when using a soldering iron.

Pre-heating	150°C, 1 min
Tip temperature	350°C max.
Soldering iron output	80W max.
Tip diameter	φ3mm max.
Soldering time	3(+1,-0)s
Time	2 times

Note :Do not directly touch the products with the tip of the soldering iron in order to prevent the crack on the products due to the thermal shock.

**9.5 Solder Volume**

- Solder shall be used not to be exceed the upper limits as shown below.
- Accordingly increasing the solder volume, the mechanical stress to Chip is also increased. Exceeding solder volume may cause the failure of mechanical or electrical performance.

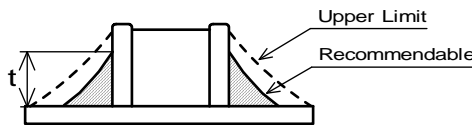

$1/3T \leq t \leq T$   
 T : thickness of product

**9.6 Mount Shock**

Over Mechanical stress to products at mounting process causes crack and electrical failure etc.

**9.7 Product's location**

The following shall be considered when designing and laying out P.C.B.'s.

- (1) P.C.B. shall be designed so that products are not subjected to the mechanical stress due to warping the board.

[Products direction]

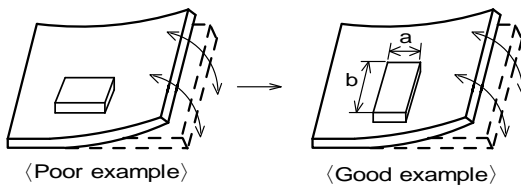

Products shall be located in the sideways direction (Length:a < b) to the mechanical stress.

- (2) Components location on P.C.B. separation.

It is effective to implement the following measures, to reduce stress in separating the board.

It is best to implement all of the following three measures; however, implement as many measures as possible to reduce stress.

Contents of Measures	Stress Level
(1) Turn the mounting direction of the component parallel to the board separation surface.	A > D *1
(2) Add slits in the board separation part.	A > B
(3) Keep the mounting position of the component away from the board separation surface.	A > C

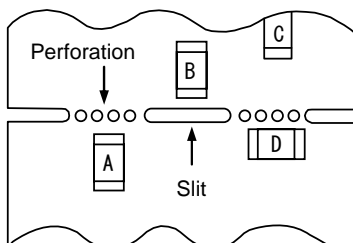

\*1 A > D is valid when stress is added vertically to the perforation as with Hand Separation. If a Cutting Disc is used, stress will be diagonal to the PCB, therefore A > D is invalid.

**(3) Mounting Components Near Screw Holes**

When a component is mounted near a screw hole, it may be affected by the board deflection that occurs during the tightening of the screw. Mount the component in a position as far away from the screw holes as possible.

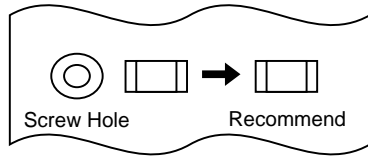
**9.8 Cleaning Conditions**

Products shall be cleaned on the following conditions.

- (1) Cleaning temperature shall be limited to 60°C max.(40°C max for IPA.)
- (2) Ultrasonic cleaning shall comply with the following conditions with avoiding the resonance phenomenon at the mounted products and P.C.B.  
Power : 20 W / l max.      Frequency : 28kHz to 40kHz      Time : 5 min max.
- (3) Cleaner
  1. Alcohol type cleaner  
Isopropyl alcohol (IPA)
  2. Aqueous agent  
PINE ALPHA ST-100S
- (4) There shall be no residual flux and residual cleaner after cleaning. In the case of using aqueous agent, products shall be dried completely after rinse with de-ionized water in order to remove the cleaner.
- (5) Other cleaning    Please contact us.

**9.9 Resin coating**

The inductance value may change and/or it may affect on the product's performance due to high cure-stress of resin to be used for coating / molding products. So please pay your careful attention when you select resin.

In prior to use, please make the reliability evaluation with the product mounted in your application set.

**9.10 Handling of a substrate**

After mounting products on a substrate, do not apply any stress to the product caused by bending or twisting to the substrate when cropping the substrate, inserting and removing a connector from the substrate or tightening screw to the substrate.

Excessive mechanical stress may cause cracking in the product.

Bending

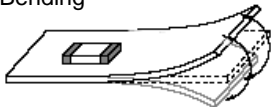

Twisting

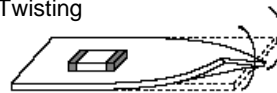
**9.11 Storage and Handling Requirements**

- (1) Storage period
  - Use the products within 6 months after delivered.
  - Solderability should be checked if this period is exceeded.
- (2) Storage conditions
  - Products should be stored in the warehouse on the following conditions.  
Temperature: -10°C to 40°C  
Humidity: 15% to 85% relative humidity    No rapid change on temperature and humidity
  - Don't keep products in corrosive gases such as sulfur, chlorine gas or acid, or it may cause oxidization of electrode, resulting in poor solderability.
  - Products should be stored on the palette for the prevention of the influence from humidity, dust and so on.
  - Products should be stored in the warehouse without heat shock, vibration, direct sunlight and so on.
  - Products should be stored under the airtight packaged condition.
- (3) Handling Condition
  - Care should be taken when transporting or handling product to avoid excessive vibration or mechanical shock.

**10. Note**

- (1) Please make sure that your product has been evaluated in view of your specifications with our product being mounted to your product.
- (2) You are requested not to use our product deviating from the reference specifications.
- (3) The contents of this reference specification are subject to change without advance notice.  
Please approve our product specifications or transact the approval sheet for product specifications before ordering.

**<Electrical Performance:Measuring Method of Inductance/Q>**

(1) Residual elements and stray elements of test fixture can be described by F-parameter shown in following.

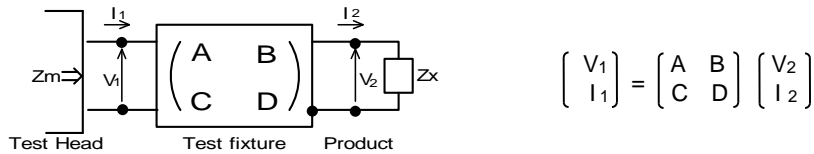

(2) The impedance of chip coil Zx and measured value Zm can be described by input/output current/voltage.

$$Z_m = \frac{V_1}{I_1} \quad , \quad Z_x = \frac{V_2}{I_2}$$

(3) Thus, the relation between Zx and Zm is following;

$$Z_x = \alpha \frac{Z_m - \beta}{1 - Z_m \Gamma} \quad \text{where, } \alpha = D / A = 1$$

$$\beta = B / D = Z_{sm} - (1 - Y_{om}) Z_{ss}$$

$$\Gamma = C / A = Y_{om}$$

- Zsm:measured impedance of short chip
- Zss:residual impedance of short chip (0.556nH)
- Yom:measured admittance when opening the fixture

(4) Lx and Qx shall be calculated with the following equation.

$$L_x = \frac{\text{Im}(Z_x)}{2\pi f} \quad , \quad Q_x = \frac{\text{Im}(Z_x)}{\text{Re}(Z_x)}$$

Lx :Inductance of chip coil  
Qx:Q of chip coil  
f :Measuring frequency