

CHIP COIL (CHIP INDUCTORS) LQG15HN□□□□02D REFERENCE SPECIFICATION

1. Scope

This reference specification applies to LQG15HN_02 series, for Chip coil (Chip Inductors).

2. Part Numbering

(ex) LQ G 15 H N 1N0 S 0 2 D
 Product ID Structure Dimension Applications Category Inductance Tolerance Features Electrode Packaging
 (L × W) and Characteristics D:Taping *B:BULK

*Bulk packing (B) also available

3. Rating

- Operating Temperature Range -55°C to +125°C
- Storage Temperature Range -55°C to +125°C

Customer Part Number	MURATA Part Number	Inductance (nH)	Tolerance	Q (min.)	DC Resistance (Ω max.)	Self Resonant Frequency (MHz min.)	Rated Current (mA)																				
	LQG15HN1N0B02D	1.0	B:±0.1nH C:±0.2nH S:±0.3nH	8	0.07	6000	1000																				
	LQG15HN1N0C02D																										
	LQG15HN1N0S02D																										
	LQG15HN1N1B02D	1.1			B:±0.1nH C:±0.2nH S:±0.3nH			8	0.08	1000																	
	LQG15HN1N1C02D																										
	LQG15HN1N1S02D																										
	LQG15HN1N2B02D	1.2							B:±0.1nH C:±0.2nH S:±0.3nH		8	0.08	1000														
	LQG15HN1N2C02D																										
	LQG15HN1N2S02D																										
	LQG15HN1N3B02D	1.3										B:±0.1nH C:±0.2nH S:±0.3nH		8	0.08	1000											
	LQG15HN1N3C02D																										
	LQG15HN1N3S02D																										
	LQG15HN1N5B02D	1.5					B:±0.1nH C:±0.2nH S:±0.3nH								8		0.08	1000									
	LQG15HN1N5C02D																										
	LQG15HN1N5S02D																										
	LQG15HN1N6B02D	1.6								B:±0.1nH C:±0.2nH S:±0.3nH							8		0.08	1000							
	LQG15HN1N6C02D																										
	LQG15HN1N6S02D																										
	LQG15HN1N8B02D	1.8											B:±0.1nH C:±0.2nH S:±0.3nH						8		0.08	1000					
	LQG15HN1N8C02D																										
	LQG15HN1N8S02D																										
	LQG15HN2N0B02D	2.0														B:±0.1nH C:±0.2nH S:±0.3nH					8		0.09	900			
	LQG15HN2N0C02D																										
	LQG15HN2N0S02D																										
	LQG15HN2N2B02D	2.2																B:±0.1nH C:±0.2nH S:±0.3nH					8		0.09	900	
	LQG15HN2N2C02D																										
	LQG15HN2N2S02D																										
	LQG15HN2N4B02D	2.4																		B:±0.1nH C:±0.2nH S:±0.3nH					8		0.10
	LQG15HN2N4C02D																										
	LQG15HN2N4S02D																										
	LQG15HN2N7B02D	2.7	B:±0.1nH C:±0.2nH S:±0.3nH	8		0.10																800					
	LQG15HN2N7C02D																										
	LQG15HN2N7S02D																										
	LQG15HN3N0B02D	3.0			B:±0.1nH C:±0.2nH S:±0.3nH	8		0.11																800			
	LQG15HN3N0C02D																										
	LQG15HN3N0S02D																										
	LQG15HN3N3B02D	3.3						B:±0.1nH C:±0.2nH S:±0.3nH	8		0.12															800	
	LQG15HN3N3C02D																										
	LQG15HN3N3S02D																										

Reference Only

Spec No. JELF243B-0009R -01

P.2/11

Customer Part Number	MURATA Part Number	Inductance (nH)	Tolerance	Q (min.)	DC Resistance (Ω max.)	Self Resonant Frequency (MHz min.)	Rated Current (mA)		
	LQG15HN3N6B02D	3.6	B:±0.1nH C:±0.2nH S:±0.3nH	8	0.13	6000	700		
	LQG15HN3N6C02D								
	LQG15HN3N6S02D								
	LQG15HN3N9B02D	3.9			0.15			5300	600
	LQG15HN3N9C02D								
	LQG15HN3N9S02D								
	LQG15HN4N3B02D	4.3			0.16	4300	500		
	LQG15HN4N3C02D								
	LQG15HN4N3S02D								
	LQG15HN4N7B02D	4.7			0.18	4200	400		
	LQG15HN4N7C02D								
	LQG15HN4N7S02D								
	LQG15HN5N1B02D	5.1			0.19	3900	350		
	LQG15HN5N1C02D								
	LQG15HN5N1S02D								
	LQG15HN5N6B02D	5.6	0.21	3600	300				
	LQG15HN5N6C02D								
	LQG15HN5N6S02D								
	LQG15HN6N2B02D	6.2	0.24	3400	250				
	LQG15HN6N2C02D								
	LQG15HN6N2S02D								
	LQG15HN6N8G02D	6.8	0.25	3200	200				
	LQG15HN6N8H02D								
	LQG15HN6N8J02D								
	LQG15HN7N5G02D	7.5	0.27	2800	150				
	LQG15HN7N5H02D								
	LQG15HN7N5J02D								
	LQG15HN8N2G02D	8.2	0.29	2300	100				
	LQG15HN8N2H02D								
	LQG15HN8N2J02D								
	LQG15HN9N1G02D	9.1	0.40	2100	75				
	LQG15HN9N1H02D								
	LQG15HN9N1J02D								
	LQG15HN10NG02D	10	0.45	1800	50				
	LQG15HN10NH02D								
	LQG15HN10NJ02D								
	LQG15HN12NG02D	12	0.51	1600	30				
	LQG15HN12NH02D								
	LQG15HN12NJ02D								
	LQG15HN15NG02D	15	0.58	1500	20				
	LQG15HN15NH02D								
	LQG15HN15NJ02D								
	LQG15HN18NG02D	18	0.67	1200	15				
	LQG15HN18NH02D								
	LQG15HN18NJ02D								
	LQG15HN22NG02D	22	1.06	1200	10				
	LQG15HN22NH02D								
	LQG15HN22NJ02D								
	LQG15HN27NG02D	27							
	LQG15HN27NH02D								
	LQG15HN27NJ02D								
	LQG15HN33NG02D	33							
	LQG15HN33NH02D								
	LQG15HN33NJ02D								
	LQG15HN39NG02D	39							
	LQG15HN39NH02D								
	LQG15HN39NJ02D								

Customer Part Number	MURATA Part Number	Inductance (nH)	Tolerance	Q (min.)	DC Resistance (Ω max.)	Self Resonant Frequency (MHz min.)	Rated Current (mA)		
	LQG15HN47NG02D	47	G: \pm 2% H: \pm 3% J: \pm 5%	8	1.15	1000	250		
	LQG15HN47NH02D								
	LQG15HN47NJ02D								
	LQG15HN56NG02D	56			1.20	800			
	LQG15HN56NH02D								
	LQG15HN56NJ02D								
	LQG15HN68NG02D	68			1.25		600		
	LQG15HN68NH02D								
	LQG15HN68NJ02D								
	LQG15HN82NG02D	82							200
	LQG15HN82NH02D								
	LQG15HN82NJ02D								
	LQG15HNR10G02D	100	1.60	600					
	LQG15HNR10H02D								
	LQG15HNR10J02D								
	LQG15HNR12G02D	120						150	
	LQG15HNR12H02D								
	LQG15HNR12J02D								

4. Testing Conditions

《Unless otherwise specified》

Temperature : Ordinary Temperature / 15°C to 35°C

Humidity : Ordinary Humidity / 25%(RH) to 85%(RH)

《In case of doubt》

Temperature : 20°C \pm 2°C

Humidity : 60%(RH) to 70%(RH)

Atmospheric Pressure : 86kPa to 106kPa

5. Appearance and Dimensions

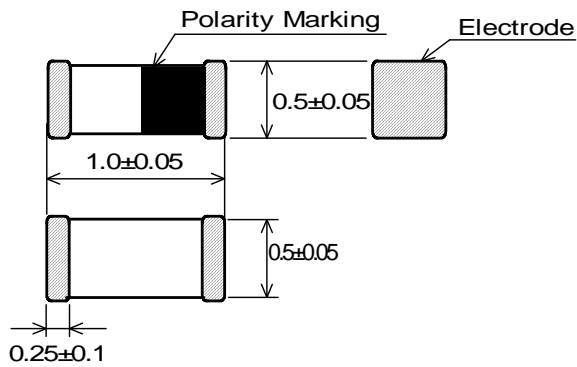

6. Electrical Performance

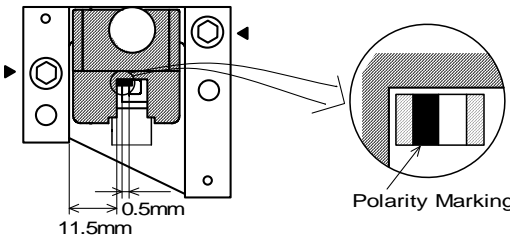
No.	Item	Specification	Test Method
6.1	Inductance	Inductance shall meet item 3.	<p>Measuring Equipment: KEYSIGHT 4291A or equivalent</p> <p>Measuring Frequency: 100MHz</p> <p>Measuring Condition: Test signal level/ about 7dBm Electrical length/ 0.94cm Weight/about 1N to 5N</p> <p>Measuring Fixture: KEYSIGHT 16193A</p> <p>Position coil under test as shown in below and contact coil with each terminal by adding weight. Polarity marking should be a topside, and polarity marking should be in the direction of the fixture for position of chip coil.</p>
6.2	Q	Q shall meet item 3.	 <p>Measuring Method: the endnote [Electrical Performance: Measuring Method of Inductance/ Q]</p>
6.3	DC Resistance	DC Resistance shall meet item 3.	Measuring Equipment: Digital multi meter
6.4	Self Resonant Frequency (S.R.F)	S.R.F shall meet item 3.	Measuring Equipment: KEYSIGHT 8753C or equivalent
6.5	Rated Current	Self temperature rise shall be limited to 25°C max.	The rated current is applied.

7. Mechanical Performance

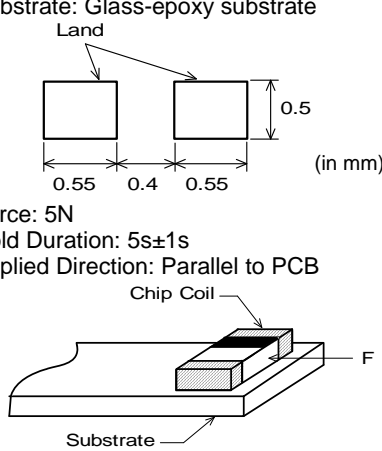
No.	Item	Specification	Test Method
7.1	Shear Test	Chip coil shall not be damaged after tested as test method.	<p>Substrate: Glass-epoxy substrate</p>  <p>Force: 5N Hold Duration: 5s±1s Applied Direction: Parallel to PCB</p>

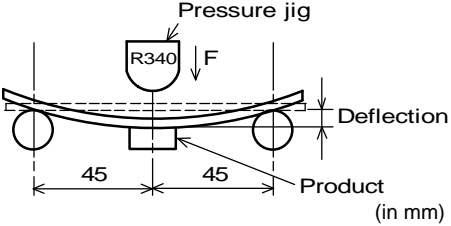
No.	Item	Specification	Test Method
7.2	Bending Test	Chip coil shall not be damaged after tested as test method.	Substrate: Glass-epoxy substrate (100mm × 40mm × 0.8mm) Speed of Applying Force: 1mm / s Deflection: 2mm Hold Duration: 30s 
7.3	Vibration	Appearance: No damage Inductance Change: within ±10%	Oscillation Frequency: 10Hz to 55Hz to 10Hz for 1 min Total Amplitude: 1.5mm Testing Time: A period of 2 hours in each of 3 mutually perpendicular directions.
7.4	Solderability	The wetting area of the electrode shall be at least 90% covered with new solder coating.	Flux: Ethanol solution of rosin 25(wt)% (Immersed for 5s to 10s) Solder: Sn-3.0Ag-0.5Cu Pre-Heating: 150°C±10°C / 60s to 90s Solder Temperature: 240°C±5°C Immersion Time: 3s±1s
7.5	Resistance to Soldering Heat	Appearance: No damage Inductance Change: within ±10%	Flux: Ethanol solution of rosin 25(wt)% (Immersed for 5s to 10s) Solder: Sn-3.0Ag-0.5Cu Pre-Heating: 150°C±10°C / 1 min to 2 min Solder Temperature: 270°C±5°C Immersion Time: 10s±1s Then measured after exposure in the room condition for 24h±2h.

8. Environmental Performance

It shall be soldered on the substrate.

No.	Item	Specification	Test Method
8.1	Humidity	Appearance: No damage Inductance Change: within ±10%	Temperature: 40°C±2°C Humidity: 90%(RH) to 95%(RH) Time: 1000h (+48h,-0h) Then measured after exposure in the room condition for 24h±2h.
8.2	Heat Life		Temperature: 125°C±2°C Current: Rated Current (See the 3.) Time: 1000h (+48h,-0h) Then measured after exposure in the room condition for 24h±2h.
8.3	Humidity Load		Temperature: 40°C±2°C Humidity: 90%(RH) to 95%(RH) Current: Rated Current (See the 3.) Time: 1000h (+48h,-0h) Then measured after exposure in the room condition for 24h±2h.
8.4	Temperature Cycle		1 cycle: 1 step: -55°C (+0°C,-3°C) / 30 min±3 min 2 step: Ordinary temp. / 2 min to 3 min 3 step: +125°C (+3°C,-0°C) / 30 min±3 min 4 step: Ordinary temp. / 2 min to 3 min Total of 10 cycles Then measured after exposure in the room condition for 24h±2h.

9. Specification of Packaging

9.1 Appearance and Dimensions of paper tape (8mm-wide)

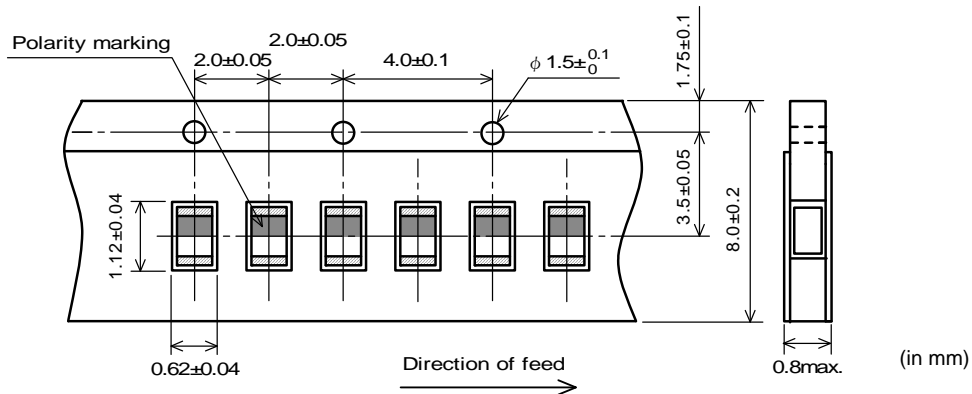

9.2 Specification of Taping

- (1) Packing quantity (standard quantity)
10,000 pcs. / reel
- (2) Packing Method
Products shall be packed in the cavity of the base tape and sealed by top tape and bottom tape.
- (3) Sprocket hole
The sprocket holes are to the right as the tape is pulled toward the user.
- (4) Spliced point
Base tape and Top tape has no spliced point.
- (5) Missing components number
Missing components number within 0.1 % of the number per reel or 1 pc., whichever is greater, and are not continuous. The Specified quantity per reel is kept.

9.3 Pull Strength

Top tape	5N min.
Bottom tape	

9.4 Peeling off force of cover tape

Speed of Peeling off	300mm / min
Peeling off force	0.1N to 0.6N (minimum value is typical)

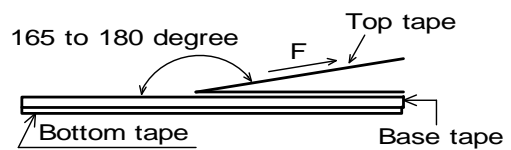

9.5 Dimensions of Leader-tape, Trailer and Reel

There shall be leader-tape (top tape and empty tape) and trailer-tape (empty tape) as follows.

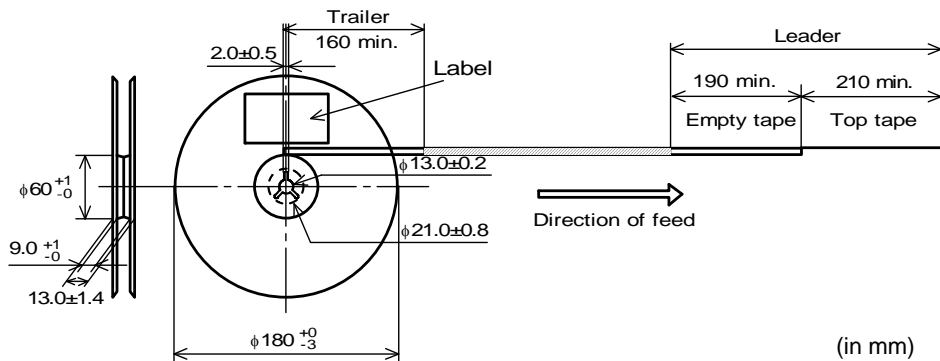

9.6 Marking for reel

Customer part number, MURATA part number, Inspection number (*1), RoHS marking (*2), Quantity etc ...

*1) <Expression of Inspection No.>

□□ 0000 xxx
 (1) (2) (3)

(1) Factory Code

(2) Date First digit : Year / Last digit of year

Second digit : Month / Jan. to Sep. → 1 to 9, Oct. to Dec. → O, N, D

Third, Fourth digit : Day

(3) Serial No.

*2) <Expression of RoHS marking>

ROHS - Y (△)
 (1) (2)

(1) RoHS regulation conformity parts.

(2) MURATA classification number

9.7 Marking for Outside package (corrugated paper box)

Customer name, Purchasing order number, Customer part number, MURATA part number, RoHS marking (*2), Quantity, etc ...

9.8. Specification of Outer Case

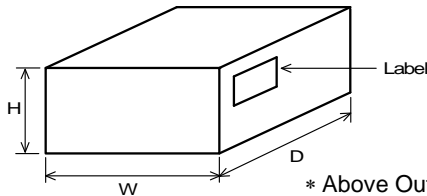

Outer Case Dimensions (mm)			Standard Reel Quantity in Outer Case (Reel)
W	D	H	
186	186	93	5

* Above Outer Case size is typical. It depends on a quantity of an order.

10. ⚠ Caution

Limitation of Applications

Please contact us before using our products for the applications listed below which require especially high reliability for the prevention of defects which might directly cause damage to the third party's life, body or property.

- | | |
|-----------------------------------|--|
| (1) Aircraft equipment | (6) Transportation equipment (vehicles, trains, ships, etc.) |
| (2) Aerospace equipment | (7) Traffic signal equipment |
| (3) Undersea equipment | (8) Disaster prevention / crime prevention equipment |
| (4) Power plant control equipment | (9) Data-processing equipment |
| (5) Medical equipment | (10) Applications of similar complexity and /or reliability requirements to the applications listed in the above |

11. Notice

Products can only be soldered with reflow.

This product is designed for solder mounting.

Please consult us in advance for applying other mounting method such as conductive adhesive.

11.1 Land pattern designing

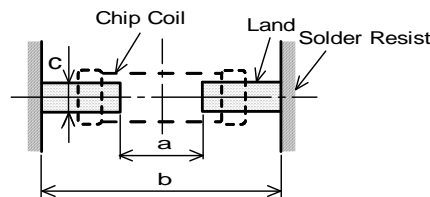

a	0.4
b	1.4 to 1.5
c	0.5 to 0.6

(in mm)

11.2 Flux, Solder

- Use rosin-based flux.
- Don't use highly acidic flux with halide content exceeding 0.2(wt)% (chlorine conversion value).
- Don't use water-soluble flux.
- Use Sn-3.0Ag-0.5Cu solder.
- Standard thickness of solder paste : 100 μm to 150 μm.

11.3 Reflow soldering conditions

- Inductance value may be changed a little due to the amount of solder.
So, the chip coil shall be soldered by reflow so that the solder volume can be controlled.
- Pre-heating should be in such a way that the temperature difference between solder and product surface is limited to 150°C max. Cooling into solvent after soldering also should be in such a way that the temperature difference is limited to 100°C max.
Insufficient pre-heating may cause cracks on the product, resulting in the deterioration of products quality.
- Standard soldering profile and the limit soldering profile is as follows.
The excessive limit soldering conditions may cause leaching of the electrode and/or resulting in the deterioration of product quality.

• Reflow soldering profile

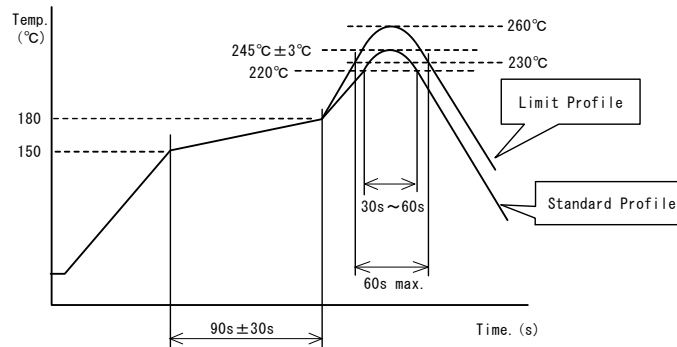

	Standard Profile	Limit Profile
Pre-heating	150°C ~ 180°C, 90s ± 30s	
Heating	above 220°C, 30s ~ 60s	above 230°C, 60s max.
Peak temperature	245°C ± 3°C	260°C, 10s
Cycle of reflow	2 times	

11.4 Reworking with soldering iron

The following conditions must be strictly followed when using a soldering iron.

Pre-heating	150°C, 1 min
Tip temperature	350°C max.
Soldering iron output	80W max.
Tip diameter	φ3mm max.
Soldering time	3(+1, -0)s
Time	2 times

Note : Do not directly touch the products with the tip of the soldering iron in order to prevent the crack on the products due to the thermal shock.

11.5 Solder Volume

- Solder shall be used not to be exceeded the upper limits as shown below.
- Accordingly increasing the solder volume, the mechanical stress to Chip is also increased.
Exceeding solder volume may cause the failure of mechanical or electrical performance.

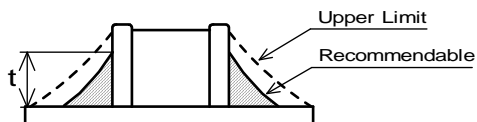

$$1/3T \leq t \leq T$$

T: thickness of product

11.6 Product's location

The following shall be considered when designing and laying out P.C.B.'s.

- (1) P.C.B. shall be designed so that products are not subject to the mechanical stress due to warping the board.

[Products direction]

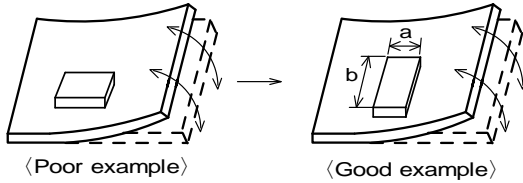

Products shall be located in the sideways direction (Length: $a < b$) to the mechanical stress.

- (2) Components location on P.C.B. separation.

It is effective to implement the following measures, to reduce stress in separating the board.

It is best to implement all of the following three measures; however, implement as many measures as possible to reduce stress.

Contents of Measures	Stress Level
(1) Turn the mounting direction of the component parallel to the board separation surface.	$A > D *1$
(2) Add slits in the board separation part.	$A > B$
(3) Keep the mounting position of the component away from the board separation surface.	$A > C$

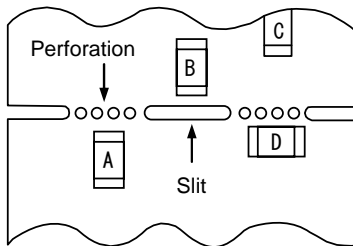

*1 $A > D$ is valid when stress is added vertically to the perforation as with Hand Separation.
If a Cutting Disc is used, stress will be diagonal to the PCB, therefore $A > D$ is invalid.

- (3) Mounting Components Near Screw Holes

When a component is mounted near a screw hole, it may be affected by the board deflection that occurs during the tightening of the screw. Mount the component in a position as far away from the screw holes as possible.

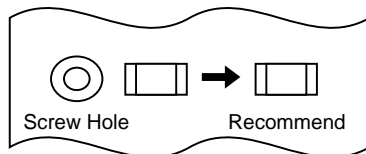

11.7 Cleaning Conditions

Products shall be cleaned on the following conditions.

- (1) Cleaning temperature shall be limited to 60°C max. (40°C max for IPA.)
- (2) Ultrasonic cleaning shall comply with the following conditions with avoiding the resonance phenomenon at the mounted products and P.C.B.

Power : 20 W / l max. Frequency : 28kHz to 40kHz Time : 5 min max.

- (3) Cleaner

- 1. Alcohol type cleaner
Isopropyl alcohol (IPA)
- 2. Aqueous agent
PINE ALPHA ST-100S

- (4) There shall be no residual flux and residual cleaner after cleaning. In the case of using aqueous agent, products shall be dried completely after rinse with de-ionized water in order to remove the cleaner.

- (5) Other cleaning Please contact us.

11.8 Resin coating

The inductance value may change and/or it may affect on the product's performance due to high cure-stress of resin to be used for coating/molding products. So please pay your careful attention when you select resin. In prior to use, please make the reliability evaluation with the product mounted in your application set.

11.9 Handling of a substrate

After mounting products on a substrate, do not apply any stress to the product caused by bending or twisting to the substrate when cropping the substrate, inserting and removing a connector from the substrate or tightening screw to the substrate.

Excessive mechanical stress may cause cracking in the product.

Bending

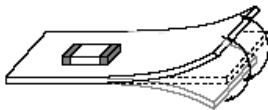

Twisting

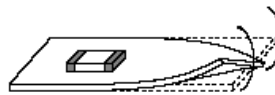
**11.10 Storage and Handling Requirements****(1) Storage period**

Use the products within 6 months after delivered.

Solderability should be checked if this period is exceeded.

(2) Storage conditions

•Products should be stored in the warehouse on the following conditions.

Temperature : -10°C to 40°C

Humidity : 15% to 85% relative humidity No rapid change on temperature and humidity

Don't keep products in corrosive gases such as sulfur, chlorine gas or acid, or it may cause oxidization of electrode, resulting in poor solderability.

•Products should be stored on the palette for the prevention of the influence from humidity, dust and so on.

•Products should be stored in the warehouse without heat shock, vibration, direct sunlight and so on.

•Products should be stored under the airtight packaged condition.

(3) Handling Condition

Care should be taken when transporting or handling product to avoid excessive vibration or mechanical shock.

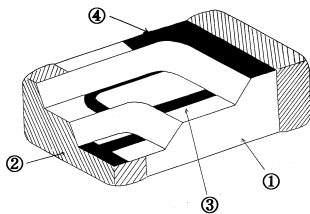
12. Structure, Construction material

No.	Item	General Material Name
①	Body	Low Dielectric Constant Ceramic
②	Outer Electrode	Ag+Ni plating+Sn plating
③	Inner Electrode	Ag
④	Marking	Stained Glass (Black)

13. Country of origin, Production Plant

Country of origin : Japan

Production Plant : Murata Manufacturing Co., Ltd. Yokaichi Plant
4-4-1, Higashiokino, Higashiomi-shi, Shiga

12. ⚠ Note

- (1) Please make sure that your product has been evaluated in view of your specifications with our product being mounted to your product.
- (2) You are requested not to use our product deviating from the reference specifications.
- (3) The contents of this reference specification are subject to change without advance notice.
Please approve our product specifications or transact the approval sheet for product specifications before ordering.

<Electrical Performance: Measuring Method of Inductance/Q>

(1) Residual elements and stray elements of test fixture can be described by F-parameter shown in following.

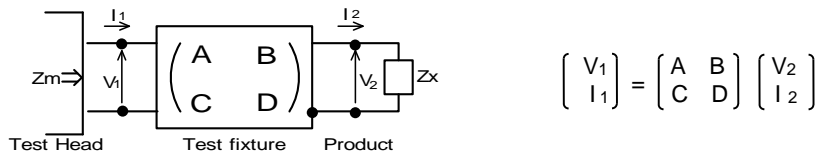

(2) The impedance of chip coil Z_x and measured value Z_m can be described by input/output current/voltage.

$$Z_m = \frac{V_1}{I_1}, \quad Z_x = \frac{V_2}{I_2}$$

(3) Thus, the relation between Z_x and Z_m is following;

$$Z_x = \alpha \frac{Z_m - \beta}{1 - Z_m \Gamma}$$

where, $\alpha = D / A = 1$
 $\beta = B / D = Z_{sm} - (1 - Y_{om} Z_{sm}) Z_{ss}$
 $\Gamma = C / A = Y_{om}$

- Z_{sm} : measured impedance of short chip
- Z_{ss} : residual impedance of short chip (0.556nH)
- Y_{om} : measured admittance when opening the fixture

(4) L_x and Q_x shall be calculated with the following equation.

$$L_x = \frac{\text{Im}(Z_x)}{2\pi f}, \quad Q_x = \frac{\text{Im}(Z_x)}{\text{Re}(Z_x)}$$

L_x : Inductance of chip coil
 Q_x : Q of chip coil
 f : Measuring frequency