

PRODUCT SPECIFICATIONS

SHARP

AVC Liquid Crystal Displays Group

LQ121S1LG41

TFT-LCD Module

Spec. Issue Date: June 13, 2005

No: LD-15606C

PREPARED BY : DATE	SHARP	SPEC No. LD-15606C
APPROVED BY : DATE		FILE No.
		ISSUE : JUN. 20. 2003
		PAGE : 17 pages
	MOBILE LIQUID CRYSTAL DISPLAY GROUP SHARP CORPORATION	APPLICABLE GROUP MOBILE LIQUID CRYSTAL DISPLAY GROUP

SPECIFICATION

REVISION: JUN. 13. 2005

DEVICE SPECIFICATION FOR
TFT-LCD Module
 MODEL No.
LQ121S1LG41

These parts have corresponded with the RoHS directive.

CUSTOMER'S APPROVAL

DATE _____

BY _____

PRESENTED

BY *T. Naka*

T. NAKA
 Division deputy general manager of
 Mobile LCD design senter II
 ENGINEERING DEPARTMENT V
 MOBILE LCD DESIGN CENTER II
 MOBILE LIQUID CRYSTAL DISPLAY GROUP
 SHARP CORPORATION

RECORDS OF REVISION

LQ121S1LG41

SPEC No.	DATE	SUMMARY		NOTE
		PAGE		
LD-15606	JUN. 20. 2003	-		1 st Issue
LD-15606A	OCT. 30. 2003	2	3. Mechanical technical literature. Add : Number of colors(Number of gray scale level)	
		4	4-2 LVDS Interface block diagram Add : R/L,U/D,VCC,GND	
		4	4-3. Backlight driving Change : Color of FL cable	
		5	Add: 6.Recommended operation condition	
		8	8-1. Timing characteristics Change : Hsync cycle(Min) 840 clock → 832 clock	
		11	10. Optical Characteristics Add : Chromaticity of Red,Green,Blue	
		13	12.Handling Precautions Add : h) Since there is a circuit··· p) Be careful of a back light ···	
		13	13.Packing form Add: Product Country TAIWAN	
		14	14.Reliability test items : normal operation state Add: Temperature, Humidity, Atmospheric pressure	
		14	15-1 Lot No. Label: Add: Discernment code Add: Taiwan product code	
		14	15-2 Packing box Label: Add: Taiwan product code	
LD-15606B	JUN. 25. 2004	13	13. Packing form Add: Product Country CHINA	
		14	15-1. Lot No. Label: Add: China product code	
		14	15-2 Packing box Label: Add: China product code	
LD-15606C	JUN. 13. 2005	6	7. Electrical Characteristics Change: Current dissipation ※It is applied from the delivery in October, 2005. Vcc=3.3V: 430mA(Typ.) → 380mA, 530mA(Max.) → 480mA Vcc=5.0V: 260mA(Typ.) → 230mA, 310mA(Max.) → 280mA	
		13	12.Handling Precautions Add: q) When install LCD modules···	
		15	15-2 Packing box Label: Add: RoHS Compliance ※It is applied from the delivery in April, 2005.	
		16	Fig1. OUTLINE DIMENSIONS Add: Recommended tighten torque for mounting 0.294±0.02N·m (3.0±0.2kgf·cm)	

1. Application

This specification applies to color TFT-LCD module, LQ121S1LG41

These specification sheets are the proprietary product of SHARP CORPORATION("SHARP) and include materials protected under copyright of SHARP. Do not reproduce or cause any third party to reproduce them in any form or by any means, electronic or mechanical, for any purpose, in whole or in part, without the express written permission of SHARP.

The device listed in these specification sheets was designed and manufactured for use in general electronic equipment.

In case of using the device for applications such as control and safety equipment for transportation (aircraft, trains, automobiles, etc.), rescue and security equipment and various safety related equipment which require higher reliability and safety, take into consideration that appropriate measures such as fail-safe functions and redundant system design should be taken.

Do not use the device for equipment that requires an extreme level of reliability, such as aerospace applications, telecommunication equipment (trunk lines), nuclear power control equipment and medical or other equipment for life support.

SHARP assumes no responsibility for any damage resulting from the use of the device which does not comply with the instructions and the precautions specified in these specification sheets.

Contact and consult with a SHARP sales representative for any questions about this device.

2. Overview

This module is a color active matrix LCD module incorporating amorphous silicon TFT (Thin Film Transistor). It is composed of a color TFT-LCD panel, driver ICs, control circuit and power supply circuit and a backlight unit. Graphics and texts can be displayed on a 800 X 3 X 600 dots panel with 262,144 colors by using LVDS (Low Voltage Differential Signaling) system for interface and supplying +3.3V +5.0V DC supply voltage for TFT-LCD panel driving and supply voltage for backlight.

The TFT-LCD panel used for this module is a low-reflection and higher-color-saturation type.

Therefore, this module is also suitable for the multimedia use. Viewing angle is 6 o'clock direction.

This module is the type of wide viewing angle and high brightness(370cd/m2).

Backlight-driving DC/AC inverter is not built in this module.

3. Outline Specifications

Parameter	Specifications	Unit
Display size	31 (12.1") Diagonal	cm
Active area	246.0 (H) X 184.5 (V)	mm
Pixel format	800 (H) X 600 (V)	pixel
	(1 pixel=R+G+B dots)	
Number of colors (Number of gray scale level)	262, 144 colors (64 gray scales per color)	
Pixel pitch	0.3075 (H) X 0.3075 (V)	mm
Pixel configuration	R,G,B vertical stripe	
Display mode	Normally white	
Unit outline dimensions *1	276.0(W)×209.0(H)×Max.11.0 (D) *Outline dimensions is shown in Fig.1	mm
Mass	MAX. 660	g
Surface treatment	Anti-glare and hard-coating 3H	

[Note] excluding backlight cables.

4. Input Terminals

4-1. TFT-LCD panel driving

CN1 (LVDS signals , +3.3V / +5.0V DC power supply and Control signal)

Corresponding connector:FI-SE20M (JAE) or FI-S20S (JAE)

Pin No.	Symbol	Function	Remark
1	V _{CC}	+3.3V / +5.0V power supply	
2	V _{CC}	+3.3V / +5.0V power supply	
3	GND		
4	GND		
5	RXIN0-	Differential data input, CH0 (negative)	LVDS signal
6	RXIN0+	Differential data input, CH0 (positive)	LVDS signal
7	GND		
8	RXIN1-	Differential data input, CH1 (negative)	LVDS signal
9	RXIN1+	Differential data input, CH1 (positive)	LVDS signal
10	GND		
11	RXIN2-	Differential data input, CH2 (negative)	LVDS signal
12	RXIN2+	Differential data input, CH2 (positive)	LVDS signal
13	GND		
14	RXCLK IN-	Differential clock input (negative)	LVDS signal
15	RXCLK IN+	Differential clock input (positive)	LVDS signal
16	GND		
17	R/L	Horizontal display mode select signal	[Note1]
18	U/D	Vertical display mode select signal	[Note2]
19	GND		
20	GND		

[Note] To obtain the proper relation between LVDS signals and actual digital data signals, the digital signals should be inputted into the transmitter as described in the next section, 4-2. The shielding case is connected with signal GND.

[Note 1],[Note 2]

R/L = High, U/D = Low

R/L = Low, U/D = Low

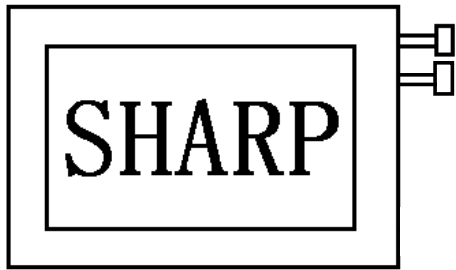

R/L = High, U/D = High



R/L = Low, U/D = High

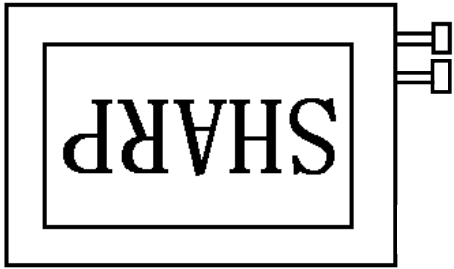

4-2 LVDS Interface block diagram

Using receiver : Single LVDS interface, which equals THC63LVDF64A(THine), contained in a control IC
 Corresponding Transmitter : DS90C363, DS90C363A, DS90C383, DS90C383A (National semiconductor),
 THC63LVDF63A, THC63LVDM63A(THine), SN75LVDS84(Ti)

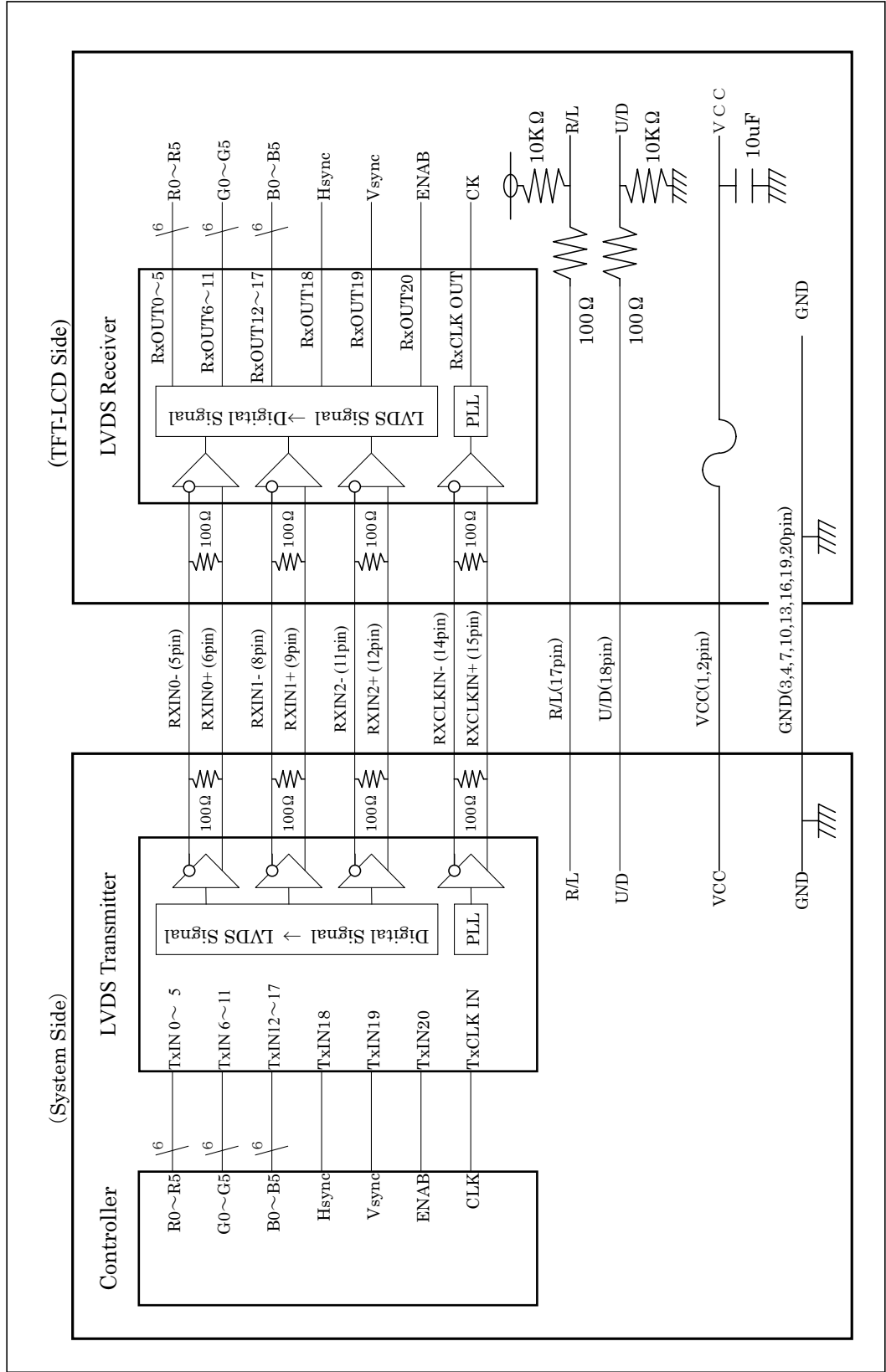

4-3. Backlight driving CN2 ,CN3

Used connector : BHR-03VS-1(JST)

Corresponding connector :SM02(8.0)B-BHS(JST)

Pin no.	symbol	function	Color of FL cable	
			CN2	CN3
1	VHIGH	Power supply for lamp (High voltage side)	Pink	Blue
2	NC	This is electrically opened.		
3	VLOW	Power supply for lamp (Low voltage side)	White	Brown

5. Absolute Maximum Ratings

Parameter	Symbol	Condition	Pin name	Ratings	Unit	Remark
+3.3V / +5.0V supply voltage	V _{CC}	T _a =25°C	V _{CC}	0 to +6.0	V	
Input voltage	VI1	T _a =25°C	RXINi-/+(i= 0,1,2)	-0.3 to V _{CC} +0.3	V	V _{CC} <3.0V
			RXCLK IN-/+	-0.3 to 3.3V	V	3.0V ≤ V _{CC}
	VI2	T _a =25°C	R/L , U/D	-0.3 to V _{CC} +0.3	V	
Storage temperature	T _{stg}	-	-	-30 to +70	°C	[Note1]
Operating temperature	T _{opa}	Ambient	-	-10 to +65	°C	

[Note1] Humidity: 95%RH Max. at T_a<=40°C.

Maximum wet-bulb temperature at 39°C or less at T_a>40°C.

No condensation.

6.Recommended operation condition

Parameter	Symbol	Min.	Typ.	Max.	Unit	Remark
Supply voltage	V _{CC}	+3.0	+3.3/+5.0	+5.5	V	[Note1]
LVDS Signals	V _L	0		2.4	V	[Note2]
Input voltage	V _I	0		V _{CC}	V	[Note3]
Ambient temperature	T _{opa}	-10		+65	°C	[Note4]

[Note1]On-off conditions for supply voltage

$$0 < t_1 \leq 15\text{ms}$$

$$0 < t_2 \leq 10\text{ms}$$

$$0 < t_3 \leq 100\text{ms}$$

$$0 < t_4 \leq 1\text{s}$$

$$200\text{ms} < t_5$$

V_{CC}-dip conditions

$$1) 2.5\text{V} \leq V_{CC}$$

$$t_d \leq 10\text{ms}$$

$$2) V_{CC} < 2.5\text{V}$$

V_{CC}-dip conditions should also follow the On-off conditions for supply voltage

[Note2] RXIN0-, RXIN0+, RXIN1-, RXIN1+, RXIN2-, RXIN2+,
RXCLK IN-, RXCLK IN+

[Note3] R/L, U/D

[Note4] Humidity: 95%RH Max. at T_a<=40°C.

Maximum wet-bulb temperature at 39°C or less at T_a>40°C.

No condensation.

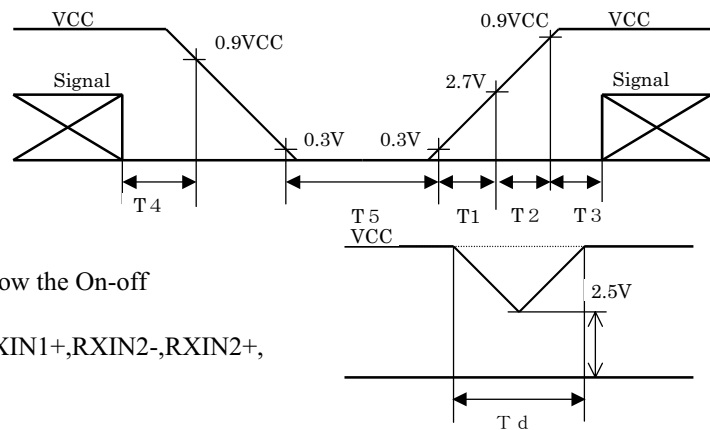

7. Electrical Characteristics

7-1. TFT-LCD panel driving

Ta=25 °C

Parameter		Symbol	Min.	Typ.	Max.	Unit	Remark
Current dissipation	Vcc=+3.3V	Icc	-	380	480	mA	[Note1]
	Vcc=+5.0V	Icc	-	230	280	mA	
Permissive input ripple voltage		VRP	-	-	100	mVp-p	
Input voltage range	LVDS signal	VL	0	-	2.4	V	[Note2]
Differential input threshold voltage	High	VTH	-	-	VCM+ 100	mV	V _{CM} =1.2V [Note3]
	Low	VTL	VCM- 100	-	-	mV	
Input impedance (Differential input)		RT	-	100	-	Ω	[Note2]
Input voltage	Low	VIL	-	-	0.8	V	[Note4]
	High	VIH	2.1	-	-		[Note5]
Input current1	Low(VI=0V)	IOL1	-800	-	-		[Note4]
	High(VI=Vcc)	IOH1	-10.0	-	10.0		
Input current2	Low(VI=0V)	IOL2	-10.0	-	10.0	uA	[Note5]
	High(VI=Vcc)	IOH2	-	-	800	uA	

[Note1] Typical current situation : 16-gray-bar pattern.

Vcc=+3.3V / +5.0V

[Note2] LVDS signals

[Note3] V_{CM} : Common mode voltage of LVDS driver.

[Note4] R/L

[Note5] U/D

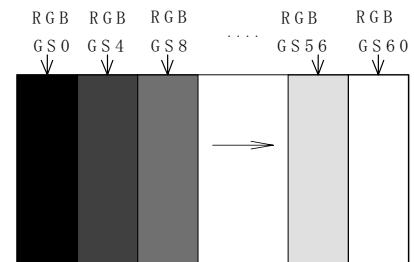

7-2. Backlight driving

The backlight system is an edge-lighting type with single CCFT (Cold Cathode Fluorescent Tube).

The characteristics of single lamp are shown in the following table.

Parameter	Symbol	Min.	Typ.	Max.	Unit	Remark
Lamp current range	IL	3.0	6.0	6.5	mArms	[Note1]
Lamp power consumption	PL	-	3.5	-	W	[Note2]
Lamp frequency	FL	40	60	80	kHz	[Note3]
Kick-off voltage	Vs	-	-	1200	Vrms	Ta=25 °C
		-	-	1400		Ta=0 °C
		-	-	1500		Ta=-10 °C
Lamp life time	LL	50000	-	-	hour	[Note5]

[Note1] Lamp current is measured with current meter for high frequency as shown below.

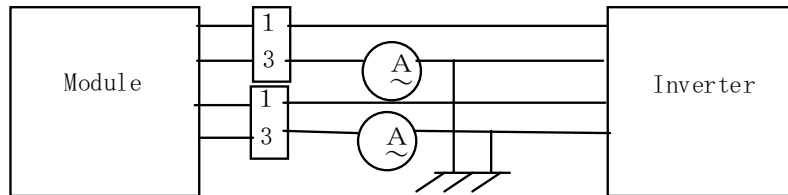

* 3pin is V_{LOW}

[Note2] At the condition of $IL=6.0\text{mArms}$

[Note3] Lamp frequency may produce interference with horizontal synchronous frequency, and this may cause beat on the display. Therefore lamp frequency shall be detached as much as possible from the horizontal synchronous frequency and from the harmonics of horizontal synchronous to avoid interference.

[Note4] The voltage above this value should be applied to the lamp for more than 1 second to start-up. Otherwise the lamp may not be turned on.

[Note5] Since lamp is consumables, the life time written above is referencial value and it is not guaranteed in this specification sheet by SHARP.

Lamp life time is defined that it applied either ① or ② under this condition (Continuous turning on at $Ta=25\text{ }^\circ\text{C}$, $IL=6.0\text{mArms}$)

① Brightness becomes 50% of the original value under standard condition.

② Kick-off voltage at $Ta=-10\text{ }^\circ\text{C}$ exceeds maximum value, 1500Vrms .

In case of operating under lower temp environment, the lamp exhaustion is accelerated and the brightness becomes lower. (Continuous operating under for around 1 month under lower temp condition may reduce the brightness to half of the original brightness.)

In case of such usage under lower temp environment, periodical lamp exchange is recommended.

[Note6] The performance of the backlight, for example life time or brightness, is much influenced by the characteristics of the DC-AC inverter for the lamp. When you design or order the inverter, please make sure that a poor lighting caused by the mismatch of the backlight and the inverter (miss-lighting, flicker, etc.) never occur. When you confirm it, the module should be operated in the same condition as it is installed in your instrument.

Be sure to use a back light power supply with the safety protection circuit such as the detection circuit for the excess voltage, excess current and or electric discharge waveform.

Be sure to use the detect circuit by which one side of the CCFT lamps can be controlled independently. Otherwise, when one side of the CCFT is open, the excess current may possibly be applied to the other side of the lamp.

Recommended inverter is "CXA-P1212B-WJL(TDK corporation)".

[Note7] It is required to have the inverter designed so that to allow the impedance deviation of the two CCFT lamps and the capacity deviation of barast capacitor.

8. Timing characteristics of input signals

8-1. Timing characteristics

(These are specified at the digital inputs/outputs of LVDS transmitter/receiver.)

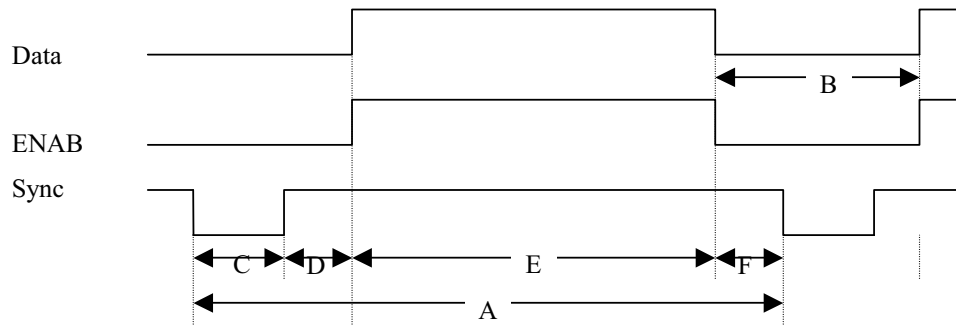

(Vertical timing)

Item(symbol)	Min.	Typ.	Max.	Unit	備考
Vsync cycle (T_{VA})	-	17.6	-	ms	Negative
	628	666	798	line	
Blanking period(T_{VB})	28	66	-	line	
Vsync pulse width (T_{VC})	2	4	6	line	
Back porch (T_{VD})	23	23	23	line	
Vsync pulse width+Back porch ($T_{VC}+T_{VD}$)	25	27	29	line	
Active display area (T_{VE})	600	600	600	line	
Front porch (T_{VF})	3	39	-	line	

(Horizontal timing)

Item(symbol)	Min.	Typ.	Max.	Unit	Remark
Hsync cycle (T_{HA})	20.8	26.4	39.9	us	Negative
	832	1056	1395	clock	
Blanking period (T_{HB})	40	256	-	clock	
Hsync pulse width (T_{HC})	2	128	200	clock	
Back porch (T_{HD})	$928-T_{HA}$	88	$T_{HA}-752$	clock	
Active display area (T_{HE})	800	800	800	clock	
Front porch (T_{HF})	0	40	-	clock	

(Clock signal)

Item	Min.	Typ.	Max.	Unit	Remark
Frequency	35	40	42	MHz	[Note1]

[Note1] In case of lower frequency, the deterioration of display quality, flicker etc., may be occurred.

(Hsync-Vsync Phase difference)

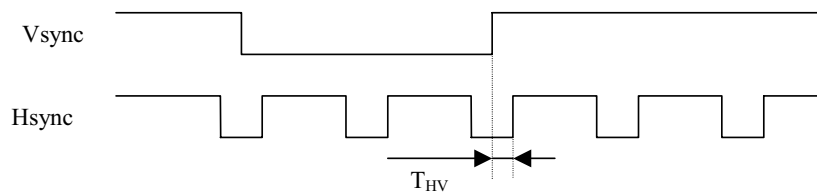

Item(symbol)	Min.	Typ.	Max.	Unit	Remark
Hsync-Vsync Phase difference (T_{HV})	1	-	$T_{HA}-T_{HC}$	clock	

(Hsync-ENAB Phase difference)

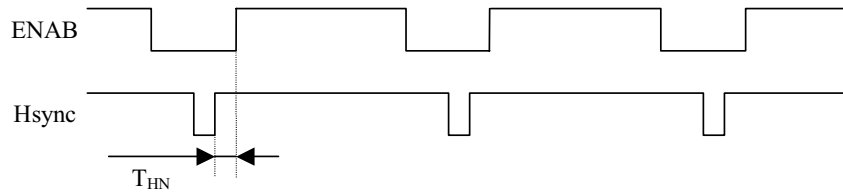

Item	Min.	Typ.	Max.	Unit	Remark
Hsync-ENAB Phase difference (T_{HN})	0	-	$T_{HA}-T_{HC}$ -800	clock	

8-2 Display position

Item	Standards	Beginning	Ending	Unit	Remark
Horizontal	rising edge of ENAB	0	800	clock	
	rising edge of Hsync	88	888	clock	[Notel]
Vertical	rising edge of Vsync	23	623	line	

[Notel] In case that ENAB signal is fixed to low level. Do not keep ENAB signal high during operation.

8-3. Input Data Signals and Display Position on the screen

Display position of input data
(H , V)

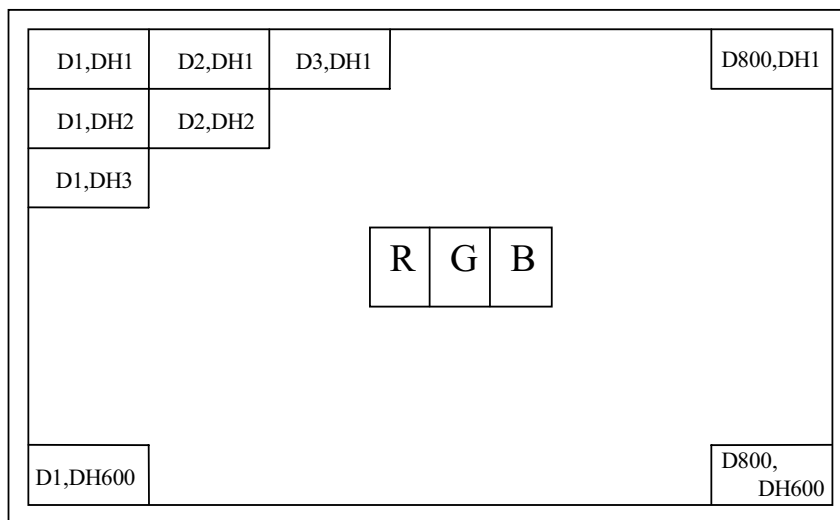

9. Input Signals, Basic Display Colors and Gray Scale of Each Color

	Colors & Gray scale	Data signal																		
		Gray Scale	R0	R1	R2	R3	R4	R5	G0	G1	G2	G3	G4	G5	B0	B1	B2	B3	B4	B5
Basic Color	Black	-	0	0	0	0	0	0	0	0	0	0	0	0	0	0	0	0	0	0
	Blue	-	0	0	0	0	0	0	0	0	0	0	0	0	1	1	1	1	1	1
	Green	-	0	0	0	0	0	0	1	1	1	1	1	1	0	0	0	0	0	0
	Cyan	-	0	0	0	0	0	0	1	1	1	1	1	1	1	1	1	1	1	1
	Red	-	1	1	1	1	1	1	0	0	0	0	0	0	0	0	0	0	0	0
	Magenta	-	1	1	1	1	1	1	0	0	0	0	0	0	1	1	1	1	1	1
	Yellow	-	1	1	1	1	1	1	1	1	1	1	1	1	0	0	0	0	0	0
	White	-	1	1	1	1	1	1	1	1	1	1	1	1	1	1	1	1	1	1
Gray Scale of Red	Black	GS0	0	0	0	0	0	0	0	0	0	0	0	0	0	0	0	0	0	0
	↑	GS1	1	0	0	0	0	0	0	0	0	0	0	0	0	0	0	0	0	0
	Darker	GS2	0	1	0	0	0	0	0	0	0	0	0	0	0	0	0	0	0	0
	↑	↓						↓					↓							
	↓	↓						↓					↓							
	Brighter	GS61	1	0	1	1	1	1	0	0	0	0	0	0	0	0	0	0	0	0
	↓	GS62	0	1	1	1	1	1	0	0	0	0	0	0	0	0	0	0	0	0
	Red	GS63	1	1	1	1	1	1	0	0	0	0	0	0	0	0	0	0	0	0
Gray Scale of Green	Black	GS0	0	0	0	0	0	0	0	0	0	0	0	0	0	0	0	0	0	0
	↑	GS1	0	0	0	0	0	0	1	0	0	0	0	0	0	0	0	0	0	0
	Darker	GS2	0	0	0	0	0	0	0	1	0	0	0	0	0	0	0	0	0	0
	↑	↓						↓					↓							
	↓	↓						↓					↓							
	Brighter	GS61	0	0	0	0	0	0	1	0	1	1	1	1	0	0	0	0	0	0
	↓	GS62	0	0	0	0	0	0	0	1	1	1	1	1	0	0	0	0	0	0
	Green	GS63	0	0	0	0	0	0	1	1	1	1	1	1	0	0	0	0	0	0
Gray Scale of Blue	Black	GS0	0	0	0	0	0	0	0	0	0	0	0	0	0	0	0	0	0	0
	↑	GS1	0	0	0	0	0	0	0	0	0	0	0	0	1	0	0	0	0	0
	Darker	GS2	0	0	0	0	0	0	0	0	0	0	0	0	0	1	0	0	0	0
	↑	↓						↓					↓							
	↓	↓						↓					↓							
	Brighter	GS61	0	0	0	0	0	0	0	0	0	0	0	0	1	0	1	1	1	1
	↓	GS62	0	0	0	0	0	0	0	0	0	0	0	0	0	1	1	1	1	1
	Blue	GS63	0	0	0	0	0	0	0	0	0	0	0	0	1	1	1	1	1	1

0 : Low level voltage, 1 : High level voltage

Each basic color can be displayed in 64 gray scales from 6 bit data signals. According to the combination of total 18 bit data signals, the 262,144-color display can be achieved on the screen.

10. Optical Characteristics

Ta=25°C, Vcc=+3.3V / +5.0V

Parameter	Symbol	Condition	Min.	Typ.	Max.	Unit	Remark	
Viewing angle range	Horizontal	$\theta 21, \theta 22$	CR>10	60	70	-	Deg.	[Note1]
	Vertical	$\theta 11$		35	50	-	Deg.	[Note4]
		$\theta 12$		55	60	-	Deg.	
Contrast ratio	CRn	$\theta = 0^\circ$	150	-	-	-	[Note2]	
	CRo	Optimum viewing angle	-	450	-	-	[Note4]	
Response time	Rise	τr	$\theta = 0^\circ$	-	15	-	ms	[Note3]
	Decay	τd		-	30	-	ms	[Note4]
Chromaticity of white	x		0.263	0.313	0.363	-	[Note4]	
	y		0.279	0.329	0.379	-		
Chromaticity of red	x		0.546	0.596	0.646	-		
	y		0.279	0.329	0.379	-		
Chromaticity of green	x		0.260	0.310	0.360	-		
	y		0.502	0.552	0.602	-		
Chromaticity of blue	x		0.098	0.148	0.198	-		
	y		0.075	0.125	0.175	-		
Luminance of white	Y_{L1}		300	370	-	cd/m ²	IL=6.0mArms fL=60kHz	
White Uniformity	δW		-	-	1.25	-	[Note5]	
Viewing angle range within defined brightness	$\theta 21, \theta 22$	50% of the maximum brightness	-	35	-	Deg.	[Note1]	
	$\theta 11$		-	25	-	Deg.		
	$\theta 12$		-	30	-	Deg.		

[Note]

The measurement shall be executed 30 minutes after lighting at rating.

The optical characteristics shall be measured in a dark room or equivalent state with the method shown in Fig.3 below.

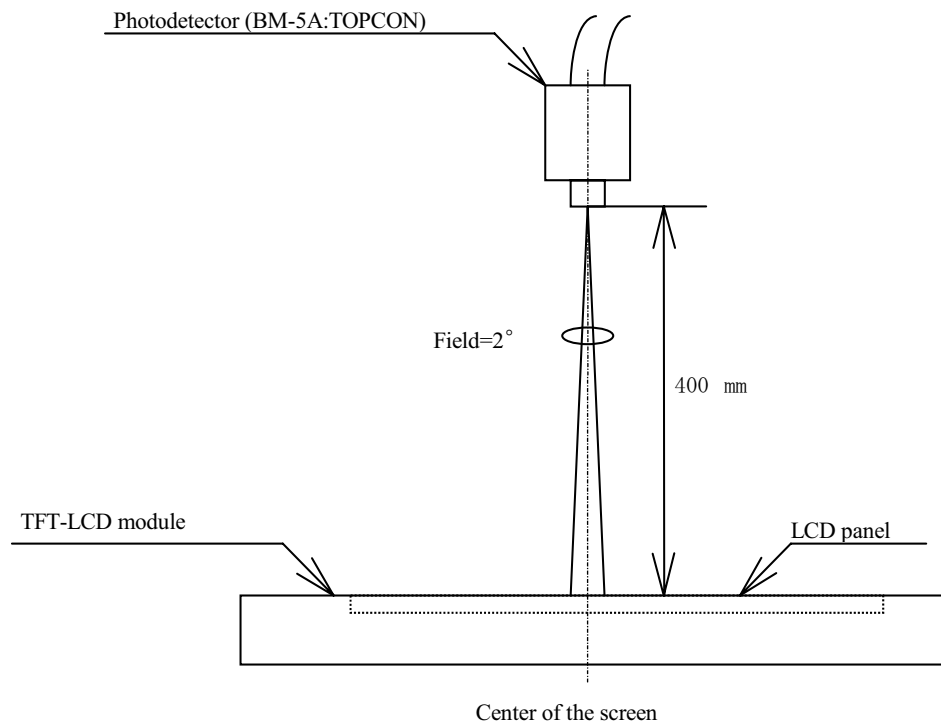
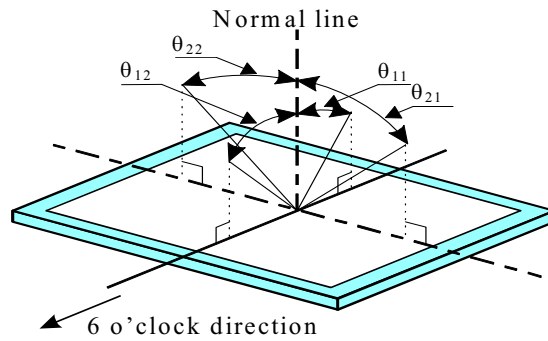

Fig.3 Optical characteristics measurement method

[Note1]Definitions of viewing angle range:



[Note2]Definition of contrast ratio:

The contrast ratio is defined as the following.

$$\text{Contrast Ratio (CR)} = \frac{\text{Luminance (brightness) with all pixels white}}{\text{Luminance (brightness) with all pixels black}}$$

[Note3]Definition of response time:

The response time is defined as the following figure and shall be measured by switching the input signal for "black" and "white" .

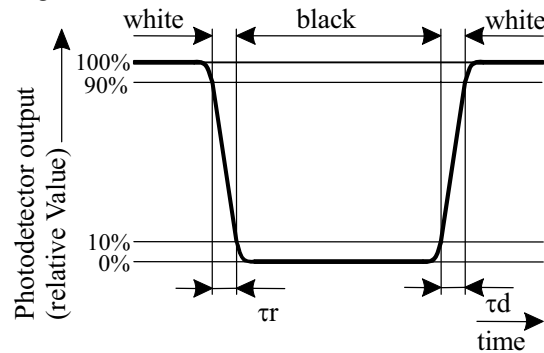

[Note4]This shall be measured at center of the screen.

[Note5]Definition of white uniformity:

White uniformity is defined as the following with five measurements (A~E).

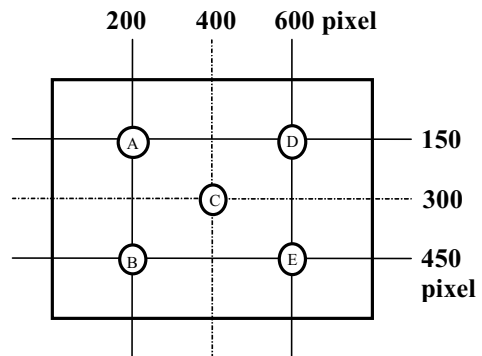

$$\delta_w = \frac{\text{Maximum Luminance of five points (brightness)}}{\text{Minimum Luminance of five points (brightness)}}$$

11. Display Quality

The display quality of the color TFT-LCD module shall be in compliance with the Incoming Inspection Standard.

12. Handling Precautions

- a) Be sure to turn off the power supply when inserting or disconnecting the cable.
- b) Be sure to design the cabinet so that the module can be installed without any extra stress such as warp or twist.
- c) Since the front polarizer is easily damaged, pay attention not to scratch it.
- d) Wipe off water drop immediately. Long contact with water may cause discoloration or spots.
- e) When the panel surface is soiled, wipe it with absorbent cotton or other soft cloth.
- f) Since the panel is made of glass, it may break or crack if dropped or bumped on hard surface. Handle with care.
- g) Since CMOS LSI is used in this module, take care of static electricity and injure the human earth when handling. Observe all other precautionary requirements in handling components.
- h) Since there is a circuit board in the module back, stress is not added at the time of a design assembly. Please make it like. If stress is added, there is a possibility that circuit parts may be damaged.
- i) Protection film is attached to the module surface to prevent it from being scratched. Peel the film off slowly, just before the use, with strict attention to electrostatic charges. Blow off 'dust' on the polarizer by using an ionized nitrogen.
- j) The polarizer surface on the panel is treated with Anti-Glare for low reflection. In case of attaching protective board over the LCD, be careful about the optical interface fringe etc. which degrades display quality.
- k) Do not expose the LCD panel to direct sunlight. Lightproof shade etc. should be attached when LCD panel is used under such environment
- l) Connect GND to 4 place of mounting holes to stabilize against EMI and external noise.
- m) There are high voltage portions on the backlight and very dangerous. Careless touch may lead to electrical shock. When exchange lamps or service, turn off the power without fail.
- n) When handling LCD modules and assembling them into cabinets, please be noted that long-term storage in the environment of oxidization or deoxidization gas and the use of such materials as reagent, solvent, adhesive, resin, etc. which generate these gasses, may cause corrosion and discoloration of the LCD modules.
- o) Cold cathode fluorescent lamp in LCD panel contains a small amount of mercury, please follow local ordinances or regulations for disposal.
- p) Be careful of a back light lead not to pull by force at the time of the wiring to an inverter, or line processing.
- q) When install LCD modules in the cabinet, please tighten with "torque=0.294±0.02N·m(3.0±0.2kgf·cm)".

13. Packing form

Product country	JAPAN	TAIWAN	CHINA
Piling number of cartons	MAX. 5		
Package quantity in one carton	10pcs		
Carton size	395(W)×275(H)×350(D) mm		
Total mass of one carton filled with full modules	8000g		
Packing form is shown	Fig.2		

14. Reliability test items

No.	Test item	Conditions	Remark
1	High temperature storage test	Ta=70°C 240h	
2	Low temperature storage test	Ta= -30°C 240h	
3	High temperature & high humidity operation test	Ta=40°C ; 95%RH 240h (No condensation)	
4	High temperature operation test	Ta=65°C 240h	
5	Low temperature operation test	Ta= -10°C 240h	
6	Vibration test (non- operating)	Frequency: 10~57Hz/Vibration width (one side):0.075mm : 58~500Hz/Gravity:9.8m/s ² Sweep time : 11 minutes Test period : 3 hours (1 hour for each direction of X,Y,Z)	
7	Shock test (non- operating)	Max. gravity : 490m/s ² Pulse width : 11ms, half sine wave Direction : ±X, ±Y, ±Z once for each direction.	
8	ESD test	Contact discharge (150pF 330Ω) non-operating = ±10kV, operating = ±8kV Atmospheric discharge (150pF 330Ω) non-operating = ±20kV, operating = ±15kV	
9	EMI	Measurement in 10m site Display position on the screen = "H" (full-screen), GND to 4 place = un-connect, Vcc / Vsignal = typ.	VCCI (Class B)

[Result Evaluation Criteria]

Under the display quality test conditions with normal operation state, these shall be no change which may affect practical display function. (normal operation state : Temperature:15~35°C, Humidity:45~75%, Atmospheric pressure:86~106kpa)

15. Others

1) Lot number Label:

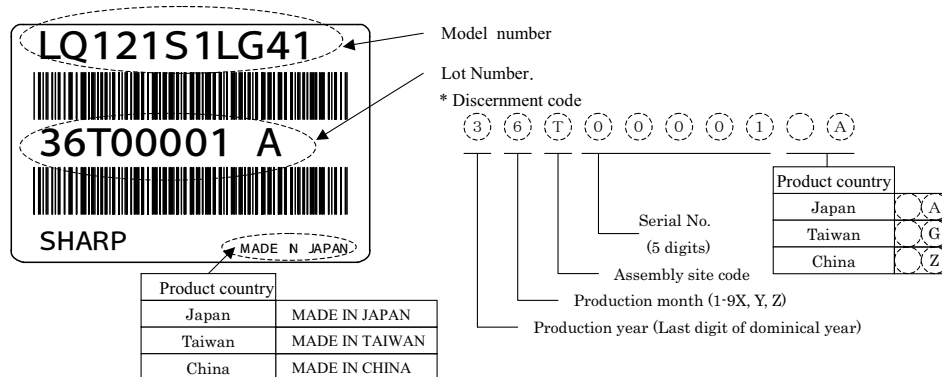

15-2 Packing box Label:

Quantity of module : Japan

社内品番 : (4 S)	LQ121S1LG41
Barcode	
Lot NO. : (1 T)	2004.08.01
Barcode	
Quantity : (Q)	10 pcs
Barcode	
ユーザ品番 :	
シャープ物流用ラベルです。	

Quantity of module : Taiwan or China

Model number	TYPE	LQ121S1LG41
Lot number (DATE)	QUANTITY	10pcs
Quantity of module	DATE	2004.8.1

Product country	
Japan	
Taiwan	LQ121S1LG41 G
China	LQ121S1LG41 Z

Internal Use Only
R. C.

※R.C. (RoHS Compliance) means these parts have corresponded with the RoHS directive.

- 15-3 Adjusting volume have been set optimally before shipment, so do not change any adjusted value.
If adjusted value is changed, the specification may not be satisfied.
- 15-4 Disassembling the module can cause permanent damage and should be strictly avoided.
- 15-5 Please be careful since image retention may occur when a fixed pattern is displayed for a long time.
- 15-6 If any problem occurs in relation to the description of this specification , it shall be resolved through discussion with spirit of cooperation.

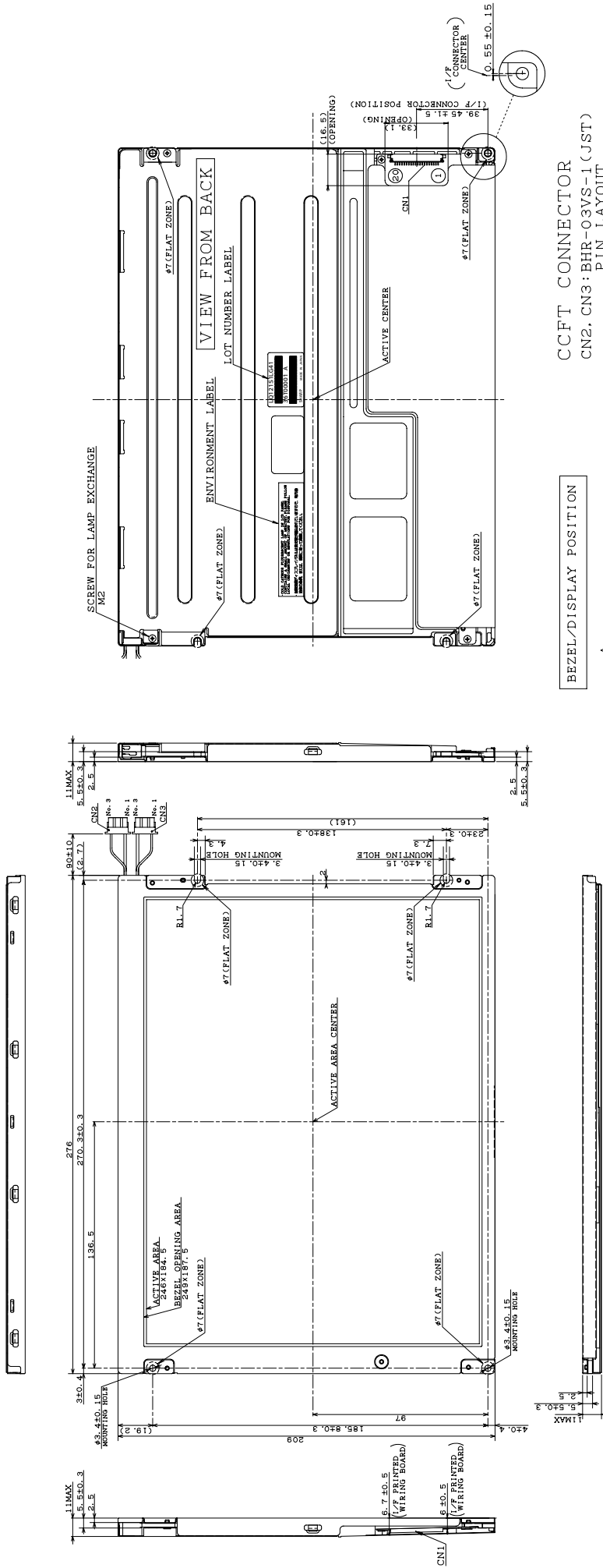

INTERFACE CONNECTOR
PIN LAYOUT

PIN	1	2	3	4	5	6	7
	VCC	VCC	GND	GND	RXINO-	RXINO+	GND
8	9	10	11	12	13	14	15
RXINI-	RXINI+	GND	RXIN2-	RXIN2+	GND	RCLKIN-	RCLKIN+
16	17	18	19	20			
GND	R/L	U/D	GND	GND			

CORRESPONDING CONNECTOR: FI-SE20M, FI-S20S

BEZEL/DISPLAY POSITION

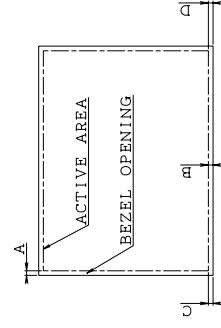

- 1) TOLERANCE X-DIRECTION A: ±0.8
- 2) TOLERANCE Y-DIRECTION B: ±0.8
- 3) BELIQUITY OF DISPLAY AREA C-D: <0.8

CCFT CONNECTOR
CN2, CN3: BHR-03VS-1 (JST)
PIN LAYOUT

1	High
2	NC
3	GND

NOTES

- 1. UNSPECIFIED TOLERANCE TO BE ±0.5
- 2. WARP AND FLATTING FOR PCB AND CHASSIS ARE EXCLUDED FROM THICKNESS AND DIMENSION OF THE UNIT.

Fig 1. OUTLINE DIMENSIONS (LQ121SILG41)

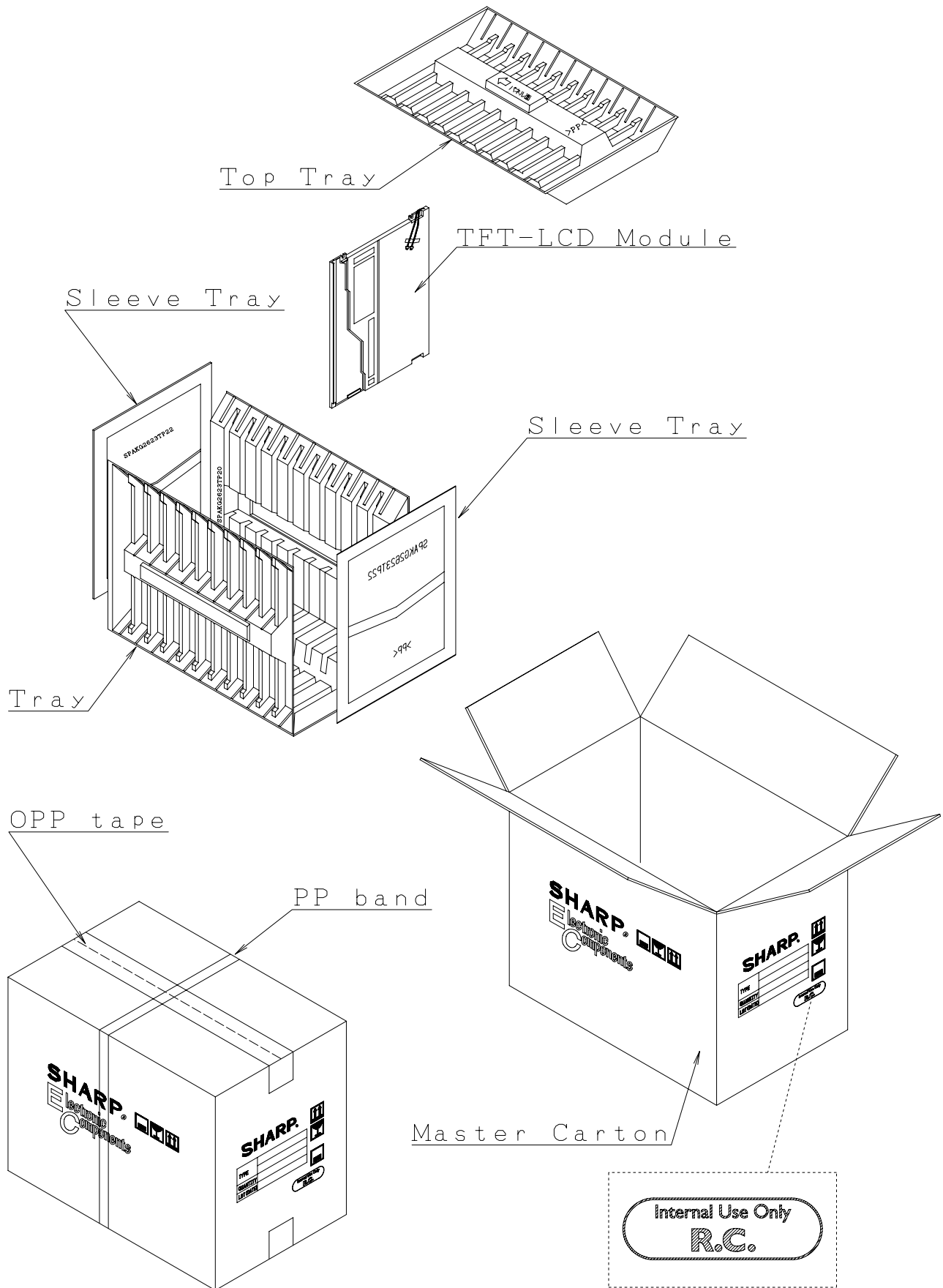

Fig2. Packing Form

NOTICE

This publication is the proprietary of SHARP and is copyrighted, with all rights reserved. Under the copyright laws, no part of this publication may be reproduced or transmitted in any form or by any means, electronic or mechanical for any purpose, in whole or in part, without the express written permission of SHARP. Express written permission is also required before any use of this publication may be made by a third party.

The application circuit examples in this publication are provided to explain the representative applications of SHARP's devices and are not intended to guarantee any circuit design or permit any industrial property right or other rights to be executed. SHARP takes no responsibility for any problems related to any industrial property right or a third party resulting from the use of SHARP's devices, except for those resulting directly from device manufacturing processes.

In the absence of confirmation by device specification sheets, SHARP takes no responsibility for any defects that occur in equipment using any of SHARP's devices, shown in catalogs, data books, etc. Contact SHARP in order to obtain the latest device specification sheets before using any SHARP's device.

SHARP reserves the right to make changes in the specifications, characteristics, data, materials, structures and other contents described herein at any time without notice in order to improve design or reliability. Contact SHARP in order to obtain the latest specification sheets before using any SHARP's device. Manufacturing locations are also subject to change without notice.

Observe the following points when using any device in this publication. SHARP takes no responsibility for damage caused by improper use *of the devices*.

The appropriate design measures should be taken to ensure reliability and safety when SHARP's devices are used for equipment such as:

- Transportation control and safety equipment (i.e., aircraft, trains, automobiles, etc.)
- Traffic signals
- Alarm equipment
- Gas leakage sensor breakers
- Various safety devices etc.

SHARP's devices shall not be used for equipment that requires extremely high level of reliability, such as:

- Military and space applications
- Medical equipment for life support
- Nuclear power control equipment

Contact a SHARP representative, in advance, when intending to use SHARP's devices for any "specific" applications other than those recommended by SHARP.

Contact and consult with a SHARP representative if there are any questions about the contents of this publication.

SPECIFICATIONS ARE SUBJECT TO CHANGE WITHOUT NOTICE.

Suggested applications (if any) are for standard use; See Important Restrictions for limitations on special applications. See Limited Warranty for SHARP's product warranty. The Limited Warranty is in lieu, and exclusive of, all other warranties, express or implied. ALL EXPRESS AND IMPLIED WARRANTIES, INCLUDING THE WARRANTIES OF MERCHANTABILITY, FITNESS FOR USE AND FITNESS FOR A PARTICULAR PURPOSE, ARE SPECIFICALLY EXCLUDED. In no event will SHARP be liable, or in any way responsible, for any incidental or consequential economic or property damage.

SHARP®

NORTH AMERICA

SHARP Microelectronics of the Americas
5700 NW Pacific Rim Blvd.
Camas, WA 98607, U.S.A.
Phone: (1) 360-834-2500
Fax: (1) 360-834-8903
Fast Info: (1) 800-833-9437
www.sharpsma.com

EUROPE

SHARP Microelectronics Europe
Division of Sharp Electronics (Europe) GmbH
Sonninstrasse 3
20097 Hamburg, Germany
Phone: (49) 40-2376-2286
Fax: (49) 40-2376-2232
www.sharpsme.com

JAPAN

SHARP Corporation
Electronic Components & Devices
22-22 Nagaike-cho, Abeno-Ku
Osaka 545-8522, Japan
Phone: (81) 6-6621-1221
Fax: (81) 6117-725300/6117-725301
www.sharp-world.com

TAIWAN

SHARP Electronic Components
(Taiwan) Corporation
8F-A, No. 16, Sec. 4, Nanking E. Rd.
Taipei, Taiwan, Republic of China
Phone: (886) 2-2577-7341
Fax: (886) 2-2577-7326/2-2577-7328

SINGAPORE

SHARP Electronics (Singapore) PTE., Ltd.
438A, Alexandra Road, #05-01/02
Alexandra Technopark,
Singapore 119967
Phone: (65) 271-3566
Fax: (65) 271-3855

KOREA

SHARP Electronic Components
(Korea) Corporation
RM 501 Geosung B/D, 541
Dohwa-dong, Mapo-ku
Seoul 121-701, Korea
Phone: (82) 2-711-5813 ~ 8
Fax: (82) 2-711-5819

CHINA

SHARP Microelectronics of China
(Shanghai) Co., Ltd.
28 Xin Jin Qiao Road King Tower 16F
Pudong Shanghai, 201206 P.R. China
Phone: (86) 21-5854-7710/21-5834-6056
Fax: (86) 21-5854-4340/21-5834-6057

Head Office:

No. 360, Bashen Road,
Xin Development Bldg. 22
Waigaoqiao Free Trade Zone Shanghai
200131 P.R. China
Email: smc@china.global.sharp.co.jp

HONG KONG

SHARP-ROXY (Hong Kong) Ltd.
3rd Business Division,
17/F, Admiralty Centre, Tower 1
18 Harcourt Road, Hong Kong
Phone: (852) 28229311
Fax: (852) 28660779
www.sharp.com.hk

Shenzhen Representative Office:

Room 13B1, Tower C,
Electronics Science & Technology Building
Shen Nan Zhong Road
Shenzhen, P.R. China
Phone: (86) 755-3273731
Fax: (86) 755-3273735