

## Cree® LMR2 LED Module

Cree LED modules provide lighting designers and manufacturers with simple, easy-to-adopt LED lighting solutions that reduce fixture development time and speed time-to-market. The Cree LMR2 LED module is the ideal choice for enabling rapid fixture development where bright, beautiful, long-life lighting is required. The LMR series of modules incorporates a compact system of integrated driver electronics, optics and primary thermal management together with 80- and 90-CRI options to address a wide range of residential and commercial lighting applications. This versatile LED lighting module jump starts the design process for 3-8" (76-203 mm) downlights, wall sconces or pendant lights.

### BENEFITS FOR LUMINAIRE DESIGNERS

- Faster time-to-market and lower system cost with complete, compact light source solution
- Reduced development time with concurrently designed and tested optics, driver electronics, and primary thermal management
- Wide variety of design applications enabled with 2700 K, 3000 K, 3500 K and 4000 K correlated color temperatures
- Industry-leading 5-year limited warranty backed by patented, reliable Cree LED technology
- Rapid regulatory approval and voluntary qualification of final luminaire enabled by:
  - ◊ UL® approval (120 V)
  - ◊ California Title 24 compliance (120 V)
  - ◊ LED LM-80 data for US ENERGY STAR®
  - ◊ Compliance with CE and other international standards (230 V)



### BENEFITS FOR END USERS

- Two color rendering options:
  - ◊ 90 CRI for retail, museums and hospitality
  - ◊ 80 CRI for general illumination
- Significant energy savings over traditional lighting through superior efficacy up to 72 lm/W
- Visually comfortable appearance whether the module is powered on or off
- Designed to last 35,000 hours at L<sub>70</sub>
- Consistent light quality over time and temperature
- Dimming down to 5% of rated light output using standard incandescent and electronic low-voltage dimmers
- No UV or mercury

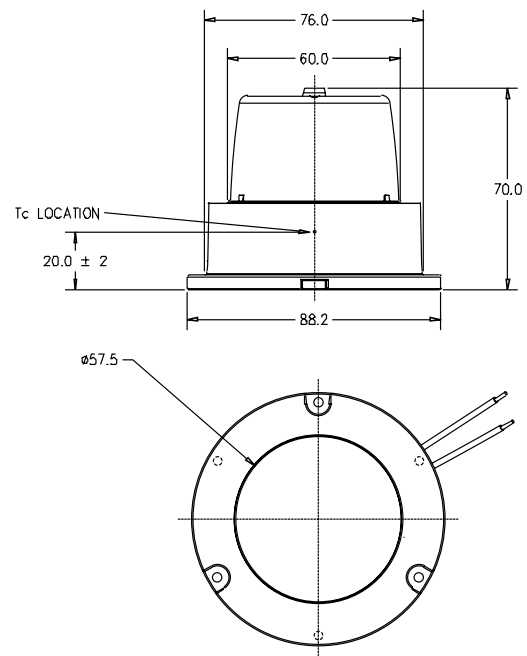

units: mm

### CHARACTERISTICS - 650 LUMENS (TRUEWHITE®)

Nominal Luminous Flux (lm)*	CCT (K)	CRI	Input Power (W)	Module Efficacy (lm/W)	Input Voltage (V)/Frequency (Hz)**	Power Factor	Dimming	Order Code
650	4000	> 90	10	65	120/60	> .80	TRIAC	LMR020-0650-40F9-10100TW
			10.5	62	230/50	> .90	TRIAC	LMR020-0650-40F9-20100TW
650	3500	> 90	10	65	120/60	> .80	TRIAC	LMR020-0650-35F9-10100TW
			10.5	62	230/50	> .90	TRIAC	LMR020-0650-35F9-20100TW
650	3000	> 90	10	65	120/60	> .80	TRIAC	LMR020-0650-30F9-10100TW
			10.5	62	230/50	> .90	TRIAC	LMR020-0650-30F9-20100TW
650	2700	> 90	10	65	120/60	> .80	TRIAC	LMR020-0650-27F9-10100TW
			10.5	62	230/50	> .90	TRIAC	LMR020-0650-27F9-20100TW

\* Luminous flux measured at Tc = 55 °C

\*\* Input ranges are 110–130 V/60 Hz and 220–240 V/50 Hz

• Maximum power = 12.1 W

Note: Cree maintains a tolerance of ±7% on flux and power measurements



### CHARACTERISTICS - 750 LUMENS

Nominal Luminous Flux (lm)*	CCT (K)	CRI	Input Power (W)	Module Efficacy (lm/W)	Input Voltage (V)/Frequency (Hz)**	Power Factor	Dimming	Order Code
750	4000	> 80	11.5	65	120/60	> .90	TRIAC	LMR020-0750-40F8-10100EW
750	3500	> 80	11.5	65	120/60	> .90	TRIAC	LMR020-0750-35F8-10100EW
750	3000	> 80	11.5	65	120/60	> .90	TRIAC	LMR020-0750-30F8-10100EW
750	2700	> 80	11.5	65	120/60	> .90	TRIAC	LMR020-0750-27F8-10100EW

\* Luminous flux measured at Tc = 55 °C

\*\* Input range is 110–130 V/60 Hz

• Maximum power = 13.5 W

Note: Cree maintains a tolerance of ±7% on flux and power measurements

### CHROMATICITY

The Cree LMR2 LED module provides high color consistency around the specified color temperature. Individual LEDs are tested and matched in order to meet our designed chromaticity specification.

Secondary optics can be added to the module but will reduce light output and may also alter the color characteristics of the final luminaire design.

**PHOTOMETRY**

**650 Lumens TrueWhite®**

**Intensity (Candlepower)**

Angle	Mean CP
0°	300
5°	298
15°	282
25°	250
35°	204
45°	153
55°	104
65°	60
75°	41
85°	2
90°	0

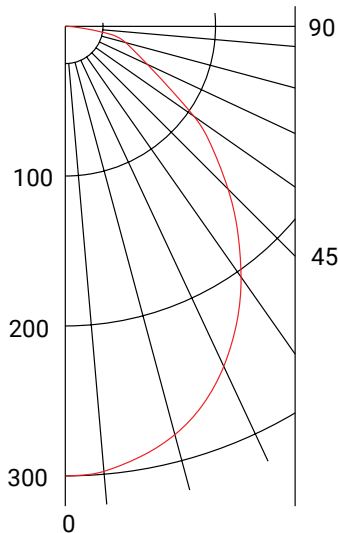

**Zonal Lumens**

Zone	Lumens	%
0-30°	222	34
0-40°	350	54
0-60°	562	86
0-90°	650	100

**750 Lumens**

**Intensity (Candlepower)**

Angle	Mean CP
0°	352
5°	350
15°	338
25°	306
35°	252
45°	181
55°	113
65°	60
75°	22
85°	2
90°	0

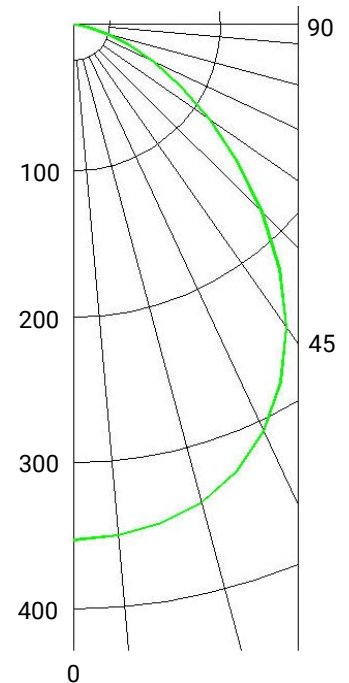

**Zonal Lumens**

Zone	Lumens	%
0-30°	269	34
0-40°	425	54
0-60°	668	86
0-90°	757	100

**THERMAL MANAGEMENT GUIDELINES**

The Cree LMR2 LED module is designed to perform in a variety of environments. To achieve lifetime and performance estimates, and to maintain the warranty, the final luminaire design cannot allow the module case temperature (Tc) point shown on page one to exceed the maximum of the ranges shown below when the fixture is at thermal equilibrium. Follow the mechanical and thermal design guidelines listed in the Cree [LMR2 LED Module Design Guide](#) to ensure proper thermal management.

Operating Temperature (at Tc point) 650 Lumens TrueWhite
0-70 °C

Operating Temperature (at Tc point) 750 Lumens
0-75 °C

Optional Heat Sink Order Code
LMR20-HS02-0000-0000001