

# LM4949 Boomer® Audio Power Amplifier Series Stereo Class D Audio Subsystem with OCL Headphone Amplifier

Check for Samples: [LM4949](#)

## FEATURES

- Output Short Circuit Protection
- Thermal Shutdown
- Stereo Filterless Class D Operation
- Selectable OCL/CC Headphone Drivers
- RF Suppression
- I<sup>2</sup>C Control Interface
- 32-step Digital Volume Control
- Independent Speaker and Headphone Gain Settings
- Minimum External Components
- Click and Pop suppression
- Micro-Power Shutdown
- Available in Space-Saving 25-Bump DSBGA Package

## APPLICATIONS

- Mobile Phones
- PDAs
- Laptops

## KEY SPECIFICATIONS

- Efficiency  $V_{DD} = 3.6V$ , 400mW into 8Ω: 86.5 %
- Efficiency  $V_{DD} = 5V$ , 1W into 8Ω: 87.4 %
- Quiescent Power Supply Current @ 3.6V : 9.36 mA
- Power Output at  $V_{DD} = 5V$ 
  - Speaker:
    - $R_L = 4\Omega$ , THD+N  $\leq 1\%$ : 2 W
    - $R_L = 8\Omega$ , THD+N  $\leq 1\%$ : 1.19 W
    - $R_L = 4\Omega$ , THD+N  $\leq 10\%$ : 2.5 W
  - Headphone:
    - $R_L = 16\Omega$ , THD+N  $\leq 1\%$ : 153 mW
    - $R_L = 32\Omega$ , THD+N  $\leq 1\%$ : 89 mW
- Shutdown Current: 0.1  $\mu A$

## DESCRIPTION

The LM4949 is a fully integrated audio subsystem designed for stereo cell phone applications. The LM4949 combines a 2.5W stereo Class D amplifier plus a separate 190mW stereo headphone amplifier, volume control, and input mixer into a single device. The filterless class D amplifiers deliver 1.19W/channel into an 8Ω load with <1% THD+N from a 5V supply. The headphone amplifier features TI's Output Capacitor-less (OCL) architecture that eliminates the output coupling capacitors required by traditional headphone amplifiers. Additionally, the headphone amplifiers can be configured with capacitively coupled (CC) loads, or used to drive an external headphone amplifier. When configured for an external amplifier, the  $V_{DD}/2$  output (VOC) controls the external amplifier's shutdown input.

For improved noise immunity, the LM4949 features fully differential left, right and mono inputs. The three inputs can be mixed/multiplexed to either the speaker or headphone amplifiers. The left and right inputs can be used as separate single-ended inputs, mixing multiple stereo audio sources. The mixer, volume control, and device mode select are controlled through an I<sup>2</sup>C compatible interface.

Output short circuit and thermal shutdown protection prevent the device from being damaged during fault conditions. Superior click and pop suppression eliminates audible transients on power-up/down and during shutdown.



Please be aware that an important notice concerning availability, standard warranty, and use in critical applications of Texas Instruments semiconductor products and disclaimers thereto appears at the end of this data sheet.

All trademarks are the property of their respective owners.

Typical Application

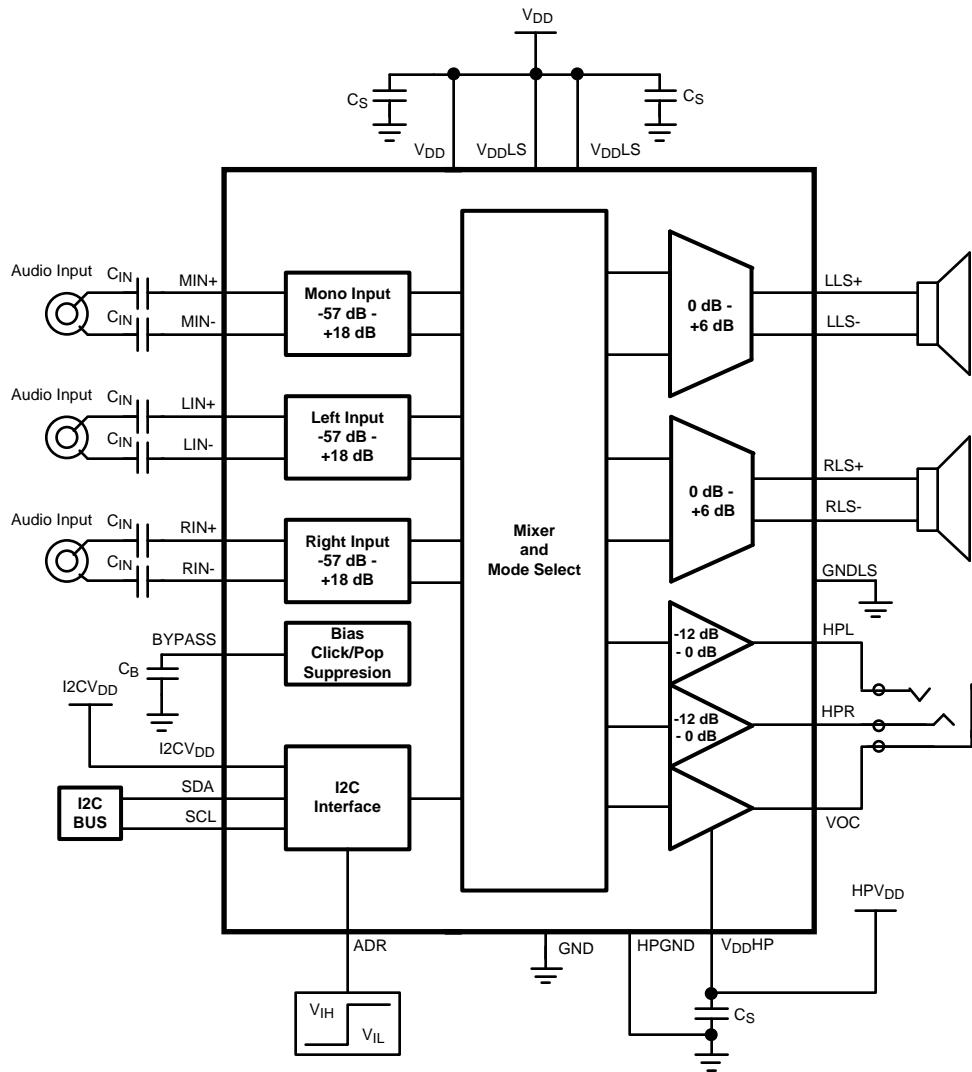

Figure 1. Typical Audio Amplifier Application Circuit

## Connection Diagram

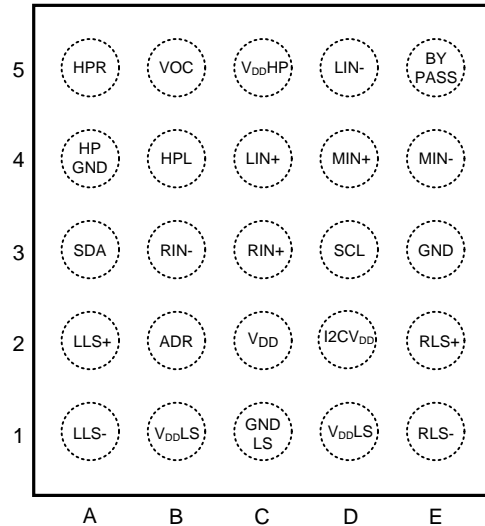

Figure 2. 25-Bump DSBGA (Top View)  
See YZR0025 Package



These devices have limited built-in ESD protection. The leads should be shorted together or the device placed in conductive foam during storage or handling to prevent electrostatic damage to the MOS gates.

## ABSOLUTE MAXIMUM RATINGS<sup>(1)(2)</sup>

Supply Voltage <sup>(3)</sup>	6.0V
Storage Temperature	-65°C to +150°C
Input Voltage	-0.3V to V <sub>DD</sub> +0.3V
Power Dissipation <sup>(4)</sup>	Internally Limited
ESD Susceptibility <sup>(5)</sup>	2000V
ESD Susceptibility <sup>(6)</sup>	200V
Junction Temperature	150°C
Thermal Resistance ( $\theta_{JA}$ )	35.1°C/W

- (1) Absolute Maximum Ratings indicate limits beyond which damage to the device may occur. Operating Ratings indicate conditions for which the device is functional, but do not ensure specific performance limits. Electrical Characteristics state DC and AC electrical specifications under particular test conditions which ensure specific performance limits. This assumes that the device is within the Operating Ratings. Specifications are not ensured for parameters where no limit is given, however, the typical value is a good indication of device performance.
- (2) If Military/Aerospace specified devices are required, please contact the Texas Instruments Sales Office/ Distributors for availability and specifications.
- (3) All voltages are measured with respect to the ground pin, unless otherwise specified.
- (4) The maximum power dissipation must be derated at elevated temperatures and is dictated by T<sub>JMAX</sub>,  $\theta_{JA}$ , and the ambient temperature T<sub>A</sub>. The maximum allowable power dissipation is P<sub>DMAX</sub> = (T<sub>JMAX</sub> - T<sub>A</sub>) /  $\theta_{JA}$  or the number given in Absolute Maximum Ratings, whichever is lower. For the LM4949, see power derating currents for additional information.
- (5) Human body model, 100pF discharged through a 1.5k $\Omega$  resistor.
- (6) Machine Model, 220pF – 240pF discharged through all pins.

## OPERATING RATINGS

Temperature Range (T <sub>MIN</sub> ≤ T <sub>A</sub> ≤ T <sub>MAX</sub> )	-40°C ≤ T <sub>A</sub> ≤ +85°C
Supply Voltage (V <sub>DD</sub> , V <sub>DDLS</sub> , V <sub>DDHP</sub> )	2.7V ≤ V <sub>DD</sub> ≤ 5.5V
I <sup>2</sup> C Voltage (I <sup>2</sup> CV <sub>DD</sub> )	2.4V ≤ I <sup>2</sup> CV <sub>DD</sub> ≤ 5.5V

**ELECTRICAL CHARACTERISTICS  $V_{DD} = 3.0V^{(1)(2)}$** 

The following specifications apply for  $A_V = 0dB$ ,  $R_{L(SP)} = 15\mu H + 8\Omega + 15\mu H$ ,  $R_{L(HP)} = 32\Omega$ ,  $f = 1kHz$  unless otherwise specified. Limits apply for  $T_A = 25^\circ C$ .

Symbol	Parameter	Conditions	LM4949		Units (Limits)		
			Typical <sup>(3)</sup>	Limit <sup>(4)(5)</sup>			
$I_{DD}$	Supply Current	LS Mode Stereo Mono	6 4.5	8.75	mA (max) mA		
		OCL HP Mode Stereo Mono	5.0 4.3	6.5	mA (max) mA		
		CC HP Mode Stereo Mono	4.0 3.3	5.25	mA (max) mA		
		Stereo LS + HP Mode	8.6		mA		
$I_{SD}$	Shutdown Supply Current		0.03	2	$\mu A$ (max)		
$V_{OS}$	Output Offset Voltage	Speaker (mode 1)	8.9	48.9	mV (max)		
		OCL HP (mode 1)	5.6	24.5	mV (max)		
$P_{OUT}$	Output Power	LS Mode, $f = 1\text{ kHz}$ $R_L = 4\Omega$ , THD+N = 10% $R_L = 4\Omega$ , THD+N = 1% $R_L = 8\Omega$ , THD+N = 10% $R_L = 8\Omega$ , THD+N = 1%	820 662 515 415	340	mW mW mW mW (min)		
		OCP HP Mode, $f = 1\text{ kHz}$ $R_L = 16\Omega$ , THD+N = 10% $R_L = 16\Omega$ , THD+N = 1% $R_L = 32\Omega$ , THD+N = 10% $R_L = 32\Omega$ , THD+N = 1%	62.5 50 37.5 30.3		mW mW mW mW		
		CC HP Mode, $f = 1\text{ kHz}$ $R_L = 16\Omega$ , THD+N = 10% $R_L = 16\Omega$ , THD+N = 1% $R_L = 32\Omega$ , THD+N = 10% $R_L = 32\Omega$ , THD+N = 1%	63 50 38 30		mW mW mW mW (min)		
		Differential Mode, $f = 1\text{ kHz}$					
		THD+N	Total Harmonic Distortion + Noise	HP Mode, $R_L = 16\Omega$ , $P_{OUT} = 35\text{mW}$ OCL CC	0.015 0.012		% %
				HP Mode, $R_L = 32\Omega$ , $P_{OUT} = 20\text{mW}$ OCL CC	0.017 0.018		% %
THD+N	Total Harmonic Distortion + Noise	LS Mode $R_L = 4\Omega$ , $P_{OUT} = 300\text{mW}$ $R_L = 8\Omega$ , $P_{OUT} = 150\text{mW}$	0.023 0.02		% %		
		Single-Ended Input Mode, $f = 1\text{ kHz}$					
THD+N	Total Harmonic Distortion + Noise	HP Mode, $R_L = 16\Omega$ , $P_{OUT} = 35\text{mW}$ OCL CC	0.023 0.017		% %		
		HP Mode, $R_L = 32\Omega$ , $P_{OUT} = 20\text{mW}$ OCL CC	0.019 0.013		% %		
		LS Mode $R_L = 4\Omega$ , $P_{OUT} = 300\text{mW}$ $R_L = 8\Omega$ , $P_{OUT} = 150\text{mW}$	0.05 0.03		% %		

(1) All voltages are measured with respect to the ground pin, unless otherwise specified.

(2) Absolute Maximum Ratings indicate limits beyond which damage to the device may occur. Operating Ratings indicate conditions for which the device is functional, but do not ensure specific performance limits. Electrical Characteristics state DC and AC electrical specifications under particular test conditions which ensure specific performance limits. This assumes that the device is within the Operating Ratings. Specifications are not ensured for parameters where no limit is given, however, the typical value is a good indication of device performance.

(3) Typicals are measured at  $25^\circ C$  and represent the parametric norm.

(4) Limits are specified to AOQL (Average Outgoing Quality Level).

(5) Datasheet min/max specification limits are specified by design, test or statistical analysis.

**ELECTRICAL CHARACTERISTICS  $V_{DD} = 3.0V^{(1)(2)}$  (continued)**

The following specifications apply for  $A_V = 0dB$ ,  $R_{L(SP)} = 15\mu H + 8\Omega + 15\mu H$ ,  $R_{L(HP)} = 32\Omega$ ,  $f = 1kHz$  unless otherwise specified. Limits apply for  $T_A = 25^\circ C$ .

Symbol	Parameter	Conditions	LM4949		Units (Limits)
			Typical <sup>(3)</sup>	Limit <sup>(4)(5)</sup>	
$e_N$	Noise	Differential Input, A-weighted, Input Referred			
		Mono Input			
		OCL	16.4		$\mu V$
		CC	15.5		$\mu V$
		LS	43		$\mu V$
		All Inputs ON			
		OCL	29.8		$\mu V$
		CC	29.2		$\mu V$
		LS	46.6		$\mu V$
		Single-Ended Input, A-weighted, Input Referred			
		Stereo Input			
		OCL	12		$\mu V$
CC	11		$\mu V$		
LA	45		$\mu V$		
All Inputs ON					
OCL	23.7		$\mu V$		
CC	22.9		$\mu V$		
LS	52		$\mu V$		
$\eta$	Efficiency	LS Mode, $P_{OUT} = 400mW$ , $R_L = 8\Omega$	85.3		%
Xtalk	Crosstalk	LS Mode, $f = 1kHz$ , $R_L = 8\Omega$ , $V_{IN} = 1V_{P-P}$			
		Differential Input Mode	84.7		dB
		OCL HP Mode, $f = 1kHz$ , $R_L = 32\Omega$ , $V_{IN} = 1V_{P-P}$			
		Differential Input Mode	68		dB
$T_{ON}$	Turn on Time	CC Mode	68		ms
		OCL Mode	14		ms
		LS Mode	29		ms
$T_{OFF}$	Turn off Time	From any mode	683		ms
$Z_{IN}$	Input Impedance	Maximum Gain	24.8		k $\Omega$
		Minimum Gain	222.7		k $\Omega$
$A_V$	Gain	Volume Control			
		Minimum Gain	-57		dB
		Maximum Gain	18		dB
		LS Second Gain Stage			
		Step 0			
		Differential Input	6		dB
		Single-Ended Input	12		dB
		Step 1			
		Differential Input	4		dB
		Single-Ended Input	10		dB
		Step 2			
		Differential Input	2		dB
		Single-Ended Input	8		dB
		Step 3			
Differential Input	0		dB		
Single-Ended Input	6		dB		
HP Second Gain Stage					
Step 0	0		dB		
Step 1	-6		dB		
Step 2	-12		dB		
Mute	Mute Attenuation	Speaker Mode	-103		dB
		Headphone Mode	-123		dB

**ELECTRICAL CHARACTERISTICS  $V_{DD} = 3.0V^{(1)(2)}$  (continued)**

The following specifications apply for  $A_V = 0dB$ ,  $R_{L(SP)} = 15\mu H + 8\Omega + 15\mu H$ ,  $R_{L(HP)} = 32\Omega$ ,  $f = 1kHz$  unless otherwise specified. Limits apply for  $T_A = 25^\circ C$ .

Symbol	Parameter	Conditions	LM4949		Units (Limits)
			Typical <sup>(3)</sup>	Limit <sup>(4)(5)</sup>	
CMRR	Common Mode Rejection Ratio	Speaker Mode, $f = 1kHz$ , $V_{IN} = 200mV_{P-P}$	66.1		dB
		OCL Headphone Mode, $f = 1kHz$ , $V_{IN} = 200mV_{P-P}$	70		dB
PSRR	Power Supply Rejection Ratio	Differential Input Mode, $V_{RIPPLE} = 200mV_{P-P}$			
		OCL HP Mode, $f = 217Hz$	78.1		dB
		OCL HP Mode, $f = 1kHz$	75.4		dB
		LS Mode, $f = 217Hz$	74		dB
PSRR	Power Supply Rejection Ratio	LS Mode, $f = 1kHz$	72.9		dB
		Single-Ended Input Mode, $V_{RIPPLE} = 200mV_{P-P}$			
		OCL HP Mode, $f = 217Hz$	77.5		dB
		OCL HP Mode, $f = 1kHz$	81		dB
PSRR	Power Supply Rejection Ratio	LS Mode, $f = 217Hz$	69		dB
		LS Mode, $f = 70.31kHz$	72.8		dB
		LS Mode, $f = 217Hz$	65.4		dB
		LS Mode, $f = 1kHz$	72.2		dB

**ELECTRICAL CHARACTERISTICS  $V_{DD} = 3.6V^{(1)(2)}$** 

The following specifications apply for  $A_V = 0dB$ ,  $R_{L(SP)} = 15\mu H + 8\Omega + 15\mu H$ ,  $R_{L(HP)} = 32\Omega$ ,  $f = 1kHz$  unless otherwise specified. Limits apply for  $T_A = 25^\circ C$ .

Symbol	Parameter	Conditions	LM4949		Units (Limits)
			Typical <sup>(3)</sup>	Limit <sup>(4)(5)</sup>	
$I_{DD}$	Supply Current	LS Mode Stereo	6.8	7.3	mA (max)
		LS Mode Mono	4.9	5.3	mA (max)
		OCL HP Mode Stereo	5.8	6.5	mA (max)
		OCL HP Mode Mono	4.9	5.5	mA (max)
$I_{SD}$	Shutdown Supply Current	CC HP Mode Stereo	4.7	5.2	mA (max)
		CC HP Mode Mono	4.1	4.6	mA (max)
$V_{OS}$	Output Offset Voltage	Stereo LS + HP Mode	9.36		mA
		Headphone	6.7	20	mV (max)
		Speaker	8.9	49	mV (max)

- (1) All voltages are measured with respect to the ground pin, unless otherwise specified.
- (2) Absolute Maximum Ratings indicate limits beyond which damage to the device may occur. Operating Ratings indicate conditions for which the device is functional, but do not ensure specific performance limits. Electrical Characteristics state DC and AC electrical specifications under particular test conditions which ensure specific performance limits. This assumes that the device is within the Operating Ratings. Specifications are not ensured for parameters where no limit is given, however, the typical value is a good indication of device performance.
- (3) Typicals are measured at  $25^\circ C$  and represent the parametric norm.
- (4) Limits are specified to AOQL (Average Outgoing Quality Level).
- (5) Datasheet min/max specification limits are specified by design, test or statistical analysis.

**ELECTRICAL CHARACTERISTICS  $V_{DD} = 3.6V^{(1)(2)}$  (continued)**

The following specifications apply for  $A_V = 0dB$ ,  $R_{L(SP)} = 15\mu H + 8\Omega + 15\mu H$ ,  $R_{L(HP)} = 32\Omega$ ,  $f = 1kHz$  unless otherwise specified. Limits apply for  $T_A = 25^\circ C$ .

Symbol	Parameter	Conditions	LM4949		Units (Limits)		
			Typical <sup>(3)</sup>	Limit <sup>(4)(5)</sup>			
$P_{OUT}$	Output Power	LS Mode, $f = 1\text{ kHz}$ $R_L = 4\Omega$ , THD+N = 10% $R_L = 4\Omega$ , THD+N = 1% $R_L = 8\Omega$ , THD+N = 10% $R_L = 8\Omega$ , THD+N = 1%	1.24 1 0.765 0.615		W W W W		
		OCL HP Mode, $f = 1\text{ kHz}$ $R_L = 16\Omega$ , THD+N = 10% $R_L = 16\Omega$ , THD+N = 1% $R_L = 32\Omega$ , THD+N = 10% $R_L = 32\Omega$ , THD+N = 1%	94 76 55 45		mW mW mW mW		
		CC HP Mode, $f = 1\text{ kHz}$ $R_L = 16\Omega$ , THD+N = 10% $R_L = 16\Omega$ , THD+N = 1% $R_L = 32\Omega$ , THD+N = 10% $R_L = 32\Omega$ , THD+N = 1%	93 75 56 45		mW mW mW mW		
		THD+N	Total Harmonic Distortion + Noise	Differential Mode, $f = 1\text{ kHz}$			
				HP Mode, $R_L = 16\Omega$ , $P_{OUT} = 50mW$ OCL CC	0.021 0.021		% %
				HP Mode, $R_L = 32\Omega$ , $P_{OUT} = 30mW$ OCL CC	0.01 0.01		% %
				LS Mode $R_L = 4\Omega$ , $P_{OUT} = 400mW$ $R_L = 8\Omega$ , $P_{OUT} = 300mW$	0.023 0.02		% %
		THD+N	Total Harmonic Distortion + Noise	Single-Ended Input Mode, $f = 1\text{ kHz}$			
				HP Mode, $R_L = 16\Omega$ , $P_{OUT} = 50mW$ OCL CC	0.021 0.017		% %
HP Mode, $R_L = 32\Omega$ , $P_{OUT} = 30mW$ OCL CC	0.02 0.015				% %		
LS Mode $R_L = 4\Omega$ , $P_{OUT} = 400mW$ $R_L = 8\Omega$ , $P_{OUT} = 300mW$	0.05 0.034				% %		
$e_N$	Noise	Differential Mode, A-weighted, Input Referred					
		Mono Input OCL CC LS	16.4 15.5 43		$\mu V$ $\mu V$ $\mu V$		
		All Inputs ON OCL CC LS	29.8 29.2 46.6		$\mu V$ $\mu V$ $\mu V$		
		Single-Ended Input, A-weighted, Input Referred					
		Stereo Input OCL CC LS	12 11 45		$\mu V$ $\mu V$ $\mu V$		
		All Inputs ON OCL CC LS	23.7 22.9 52		$\mu V$ $\mu V$ $\mu V$		
		$\eta$	Efficiency	LS Mode, $P_{OUT} = 400mW$ , $R_L = 8\Omega$	86.5		%

**ELECTRICAL CHARACTERISTICS  $V_{DD} = 3.6V^{(1)(2)}$  (continued)**

The following specifications apply for  $A_V = 0dB$ ,  $R_{L(SP)} = 15\mu H + 8\Omega + 15\mu H$ ,  $R_{L(HP)} = 32\Omega$ ,  $f = 1kHz$  unless otherwise specified. Limits apply for  $T_A = 25^\circ C$ .

Symbol	Parameter	Conditions	LM4949		Units (Limits)		
			Typical <sup>(3)</sup>	Limit <sup>(4)(5)</sup>			
Xtalk	Crosstalk	LS Mode, $f = 1kHz$ , $R_L = 8\Omega$ , $V_{IN} = 1V_{P-P}$					
		Differential Input Mode	86		dB		
		OCL HP Mode, $f = 1kHz$ , $R_L = 32\Omega$ , $V_{IN} = 1V_{P-P}$					
		Differential Input Mode	68		dB		
$T_{ON}$	Turn on Time	CC Mode	75		ms		
		OCL Mode	14		ms		
		LS Mode	31				
$T_{OFF}$	Turn off Time	From any mode	692		ms		
$Z_{IN}$	Input Impedance	Maximum Gain	24.8		k $\Omega$		
		Minimum Gain	222.7		k $\Omega$		
$A_V$	Gain	Volume Control Minimum Gain Maximum Gain	-57 18		dB dB		
		LS Second Gain Stage					
		Step 0 Differential Input Single-Ended Input	6 12		dB dB		
		Step 2 Differential Input Single-Ended Input	4 10		dB dB		
		Step 2 Differential Input Single-Ended Input	2 8		dB dB		
		Step 3 Differential Input Single-Ended Input	0 6		dB dB		
		HP Second Gain Stage					
		Step 0 Step 1 Step 2	0 -6 -12		dB dB		
		Mute	Mute Attenuation	Speaker Mode	-84		dB
				Headphone Mode	-95		dB
		CMRR	Common Mode Rejection Ratio	Speaker Mode, $f = 1kHz$ , $V_{IN} = 200mV_{P-P}$	66		dB
				OCL Headphone Mode, $f = 1kHz$ , $V_{IN} = 200mV_{P-P}$	68.6		dB
		PSRR	Power Supply Rejection Ratio	Differential Input Mode, $V_{RIPPLE} = 200mV_{P-P}$			
OCL HP Mode, $f = 217Hz$	75				dB		
OCL HP Mode, $f = 1kHz$	75				dB		
LS Mode, $f = 217Hz$	73				dB		
LS Mode, $f = 1kHz$	73				dB		
PSRR	Power Supply Rejection Ratio	Single-Ended Input Mode, $V_{RIPPLE} = 200mV_{P-P}$					
		OCL HP Mode, $f = 217Hz$	75		dB		
		OCL HP Mode, $f = 1kHz$	75		dB		
		LS Mode, $f = 217Hz$	67		dB		
		LS Mode, $f = 1kHz$	71		dB		
PSRR	Power Supply Rejection Ratio	All Inputs ON, Single-Ended Input Mode, $V_{RIPPLE} = 200mV_{P-P}$					
		OCL HP Mode, $f = 217Hz$	72		dB		
		OCL HP Mode, $f = 1kHz$	70		dB		
		LS Mode, $f = 217Hz$	60		dB		
		LS Mode, $f = 1kHz$	65		dB		



**ELECTRICAL CHARACTERISTICS  $V_{DD} = 5.0V^{(1)} (2)$** 

The following specifications apply for  $A_V = 0dB$ ,  $R_{L(SP)} = 15\mu H + 8\Omega + 15\mu H$ ,  $R_{L(HP)} = 32\Omega$ ,  $f = 1kHz$  unless otherwise specified. Limits apply for  $T_A = 25^\circ C$ .

Symbol	Parameter	Conditions	LM4949		Units (Limits)		
			Typical <sup>(3)</sup>	Limit <sup>(4)(5)</sup>			
$I_{DD}$	Supply Current	LS Mode Stereo Mono	9.9 6.6	10.9 7.2	mA (max) mA (max)		
		OCL HP Mode Stereo Mono	6.6 5.5	7.3 6.2	mA (max) mA (max)		
		CC HP Mode Stereo Mono	5.4 4.3	5.9 4.8	mA (max) mA (max)		
		Stereo LS + HP Mode	13		mA		
$I_{SD}$	Shutdown Supply Current		0.1	1	$\mu A$ (max)		
$V_{OS}$	Output Offset Voltage	Headphone	10	52	mV (max)		
		Speaker	9.6	50	mV (max)		
$P_{OUT}$	Output Power	LS Mode, $f = 1\text{ kHz}$ $R_L = 4\Omega$ , THD+N = 10% $R_L = 4\Omega$ , THD+N = 1% $R_L = 8\Omega$ , THD+N = 10% $R_L = 8\Omega$ , THD+N = 1%	2.5 2.01 1.48 1.19		W W W W		
		OCL HP Mode, $f = 1\text{ kHz}$ $R_L = 16\Omega$ , THD+N = 10% $R_L = 16\Omega$ , THD+N = 1% $R_L = 32\Omega$ , THD+N = 10% $R_L = 32\Omega$ , THD+N = 1%	190 154 109 89		mW mW mW mW		
		CC HP Mode, $f = 1\text{ kHz}$ $R_L = 16\Omega$ , THD+N = 10% $R_L = 16\Omega$ , THD+N = 1% $R_L = 32\Omega$ , THD+N = 10% $R_L = 32\Omega$ , THD+N = 1%	188 153 105 88		mW mW mW mW		
		Differential Input Mode, $f = 1\text{ kHz}$					
		THD + N	Total Harmonic Distortion + Noise	HP Mode, $R_L = 16\Omega$ , $P_{OUT} = 100mW$ OCL CC	0.02 0.027		% %
				HP Mode, $R_L = 32\Omega$ , $P_{OUT} = 50mW$ OCL CC	0.02 0.022		% %
THD + N	Total Harmonic Distortion + Noise	LS Mode $R_L = 4\Omega$ , $P_{OUT} = 1W$ $R_L = 8\Omega$ , $P_{OUT} = 600mW$	0.022 0.02		% %		
		Single-Ended Input Mode, $f = 1\text{ kHz}$					
		HP Mode, $R_L = 16\Omega$ , $P_{OUT} = 100mW$ OCL CC	0.021 0.02		% %		
		HP Mode, $R_L = 32\Omega$ , $P_{OUT} = 50mW$ OCL CC	0.02 0.017		% %		
THD + N	Total Harmonic Distortion + Noise	LS Mode $R_L = 4\Omega$ , $P_{OUT} = 1W$ $R_L = 8\Omega$ , $P_{OUT} = 600mW$	0.05 0.033		% %		

- (1) All voltages are measured with respect to the ground pin, unless otherwise specified.
- (2) Absolute Maximum Ratings indicate limits beyond which damage to the device may occur. Operating Ratings indicate conditions for which the device is functional, but do not ensure specific performance limits. Electrical Characteristics state DC and AC electrical specifications under particular test conditions which ensure specific performance limits. This assumes that the device is within the Operating Ratings. Specifications are not ensured for parameters where no limit is given, however, the typical value is a good indication of device performance.
- (3) Typical values are measured at  $25^\circ C$  and represent the parametric norm.
- (4) Limits are specified to AOQL (Average Outgoing Quality Level).
- (5) Datasheet min/max specification limits are specified by design, test or statistical analysis.

**ELECTRICAL CHARACTERISTICS  $V_{DD} = 5.0V^{(1) (2)}$  (continued)**

The following specifications apply for  $A_V = 0dB$ ,  $R_{L(SP)} = 15\mu H + 8\Omega + 15\mu H$ ,  $R_{L(HP)} = 32\Omega$ ,  $f = 1kHz$  unless otherwise specified. Limits apply for  $T_A = 25^\circ C$ .

Symbol	Parameter	Conditions	LM4949		Units (Limits)
			Typical <sup>(3)</sup>	Limit <sup>(4)(5)</sup>	
$e_N$	Noise	Differential Input, A-weighted, Input Referred			
		Mono Input			
		OCL	16.4		$\mu V$
		CC	15.5		$\mu V$
		LS	43		$\mu V$
		All Inputs ON			
		OCL	29.8		$\mu V$
		CC	29.2		$\mu V$
		LS	46.6		$\mu V$
		Single-Ended Input, A-weighted, Input Rrferred			
		Stereo Input			
		OCL	12		$\mu V$
CC	11		$\mu V$		
LS	45		$\mu V$		
All Inputs ON					
OCL	23.7		$\mu V$		
CC	22.9		$\mu V$		
LS	52		$\mu V$		
$\eta$	Efficiency	LS Mode, $P_{OUT} = 1W$ , $R_L = 8\Omega$	87.4		%
Xtalk	Crosstalk	LS Mode, $f = 1kHz$ , $R_L = 8\Omega$ , $V_{IN} = 1V_{P-P}$			
		Differential Input Mode	105.8		dB
		OCL HP Mode, $f = 1kHz$ , $R_L = 32\Omega$ , $V_{IN} = 1V_{P-P}$			
		Differential Input Mode	69.6		dB
$T_{ON}$	Turn on Time	CC Mode	89		ms
		OCL Mode	14		ms
		LS Mode	35		ms
$T_{OFF}$	Turn off Time	From any mode	716		ms
$Z_{IN}$	Input Impedance	Maximum Gain	24.8		k $\Omega$
		Minimum Gain	222.7		k $\Omega$
$A_V$	Gain	Volume Control			
		Minimum Gain	-57		dB
		Maximum Gain	18		dB
		LS Second Gain Stage			
		Step 0			
		Differential Input	6		dB
		Single-Ended Input	12		dB
		Step 1			
		Differential Input	4		dB
		Single-Ended Input	10		dB
		Step 2			
		Differential Input	8		dB
		Single-Ended Input	2		dB
		Step 3			
Differential Input	0		dB		
Single-Ended Input	6		dB		
HP Second Gain Stage					
Step 0					
Step 1	-6		dB		
Step 2	-12		dB		
Mute	Mute Attenuation	Speaker Mode	-102.7		dB
		Headphone Mode	-123		dB

**ELECTRICAL CHARACTERISTICS  $V_{DD} = 5.0V^{(1) (2)}$  (continued)**

The following specifications apply for  $A_V = 0dB$ ,  $R_{L(SP)} = 15\mu H + 8\Omega + 15\mu H$ ,  $R_{L(HP)} = 32\Omega$ ,  $f = 1kHz$  unless otherwise specified. Limits apply for  $T_A = 25^\circ C$ .

Symbol	Parameter	Conditions	LM4949		Units (Limits)
			Typical <sup>(3)</sup>	Limit <sup>(4)(5)</sup>	
CMRR	Common Mode Rejection Ratio	Speaker Mode, $f = 1kHz$ , $V_{IN} = 200mV_{P-P}$	64.4		dB
		OCL Headphone Mode, $f = 1kHz$ , $V_{IN} = 200mV_{P-P}$	74.3		dB
PSRR	Power Supply Rejection Ratio	Differential Input Mode, $V_{RIPPLE} = 200mV_{P-P}$			
		OCL HP Mode, $f = 217Hz$	68.3		dB
		OCL HP Mode, $f = 1kHz$	67.9		dB
		LS Mode, $f = 217Hz$	73.8		dB
		LS Mode, $f = 1kHz$	72		dB
PSRR	Power Supply Rejection Ratio	Single-Ended Input Mode, $V_{RIPPLE} = 200mV_{P-P}$			
		OCL HP Mode, $f = 217Hz$	70.55		dB
		OCL HP Mode, $f = 1kHz$	63.05		dB
		LS Mode, $f = 217Hz$	64.6		dB
		LS Mode, $f = 1kHz$	70.3		dB
PSRR	Power Supply Rejection Ratio	All Inputs ON, Single-Ended Input Mode, $V_{RIPPLE} = 200mV_{P-P}$			
		OCL HP Mode, $f = 217Hz$	63.1		dB
		OCL HP Mode, $f = 1kHz$	66.4		dB
		LS Mode, $f = 217Hz$	59.1		dB
		LS Mode, $f = 1kHz$	69.3		dB

**Table 1. Bump Description**

<b>BUMP</b>	<b>NAME</b>	<b>DESCRIPTION</b>
A1	LLS-	Left Channel Loudspeaker Inverting Output
A2	LLS+	Left Channel Loudspeaker Non-inverting Output
A3	SDA	Serial Data Input
A4	HPGND	Headphone Ground
A5	HPR	Right Channel Headphone Output
B1	VDDLS	Speaker Power Supply
B2	ADR	Address Select Bit
B3	RIN-	Right Channel Inverting Input
B4	HPL	Left Channel Headphone Output
B5	VOC	Headphone Return Bias Output
C1	GNDLS	Speaker Ground
C2	VDD	Power Supply
C3	RIN+	Right Channel Non-Inverting Input
C4	LIN+	Left Channel Non-inverting Input
C5	VDDHP	Headphone Power Supply
D1	VDDLS	Speaker Power Supply
D2	I <sup>2</sup> CVDD	I2C Power Supply
D3	SCL	Serial Clock Input
D4	MIN+	Mono Channel Non-inverting Input
D5	LIN-	Left Channel Inverting Input
E1	RLS-	Right Channel Loudspeaker Inverting Output
E2	RLS+	Right Channel Loudspeaker Non-inverting Output
E3	GND	Ground
E4	MIN-	Mono Channel Inverting Input
E5	BYPASS	Mid-rail Bias Bypass

TYPICAL PERFORMANCE CHARACTERISTICS

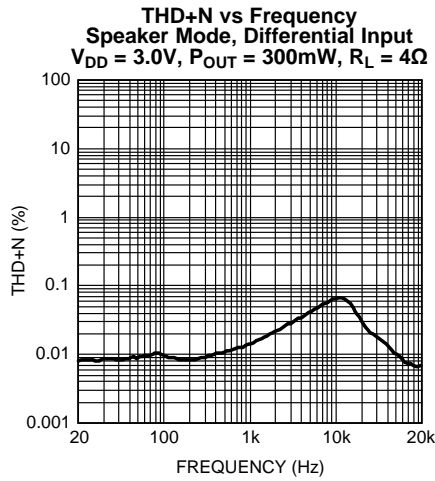

Figure 3.

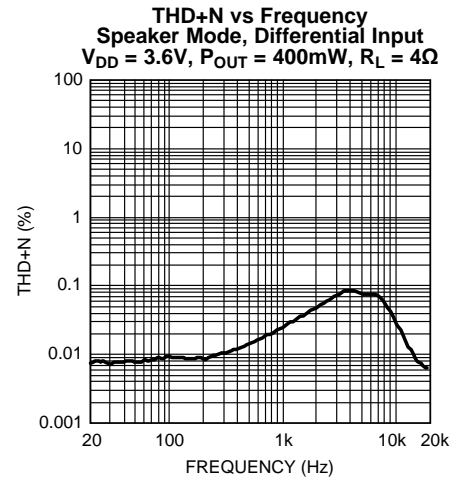

Figure 4.

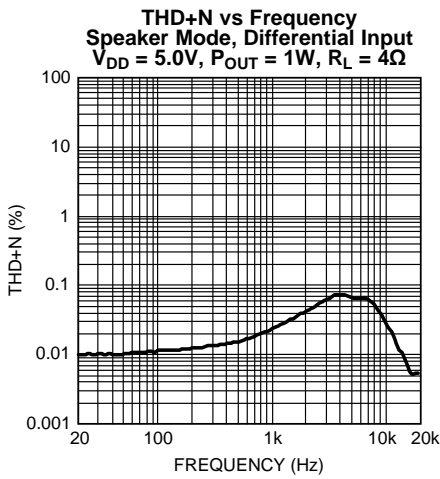

Figure 5.

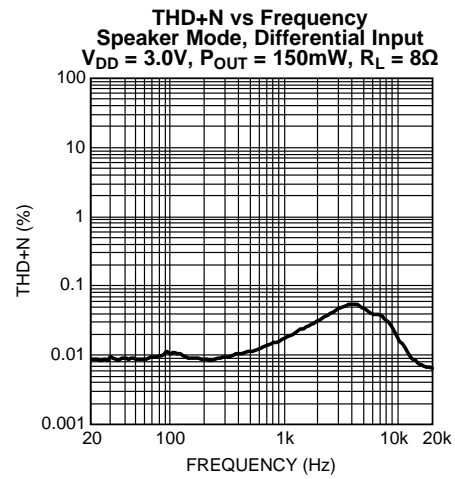

Figure 6.

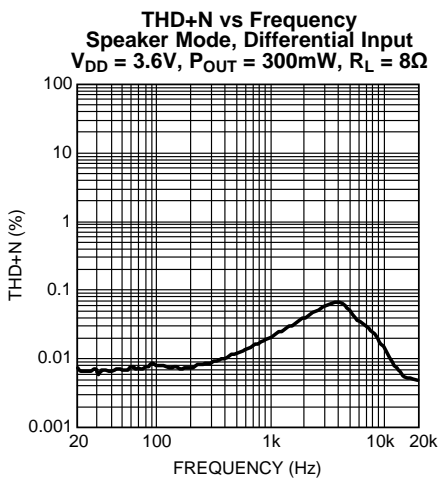

Figure 7.

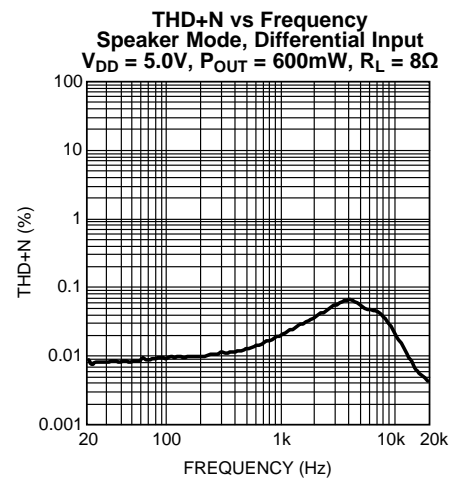

Figure 8.

**TYPICAL PERFORMANCE CHARACTERISTICS (continued)**

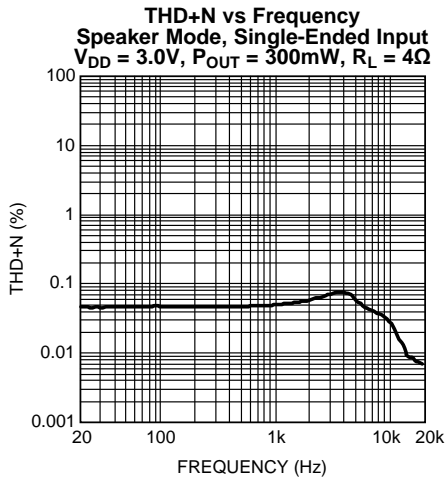

Figure 9.

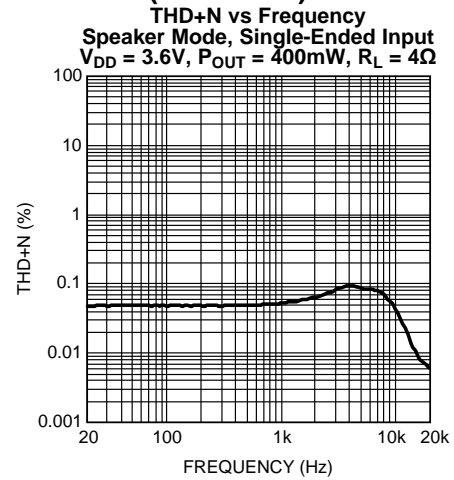

Figure 10.

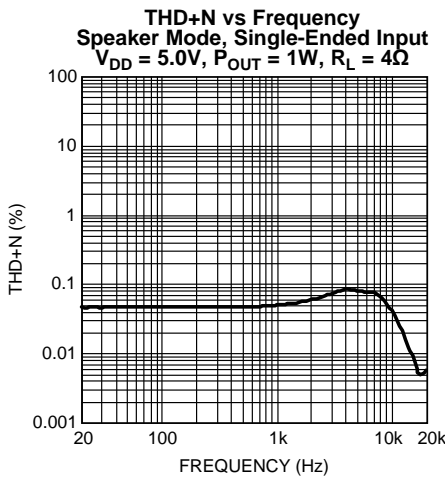

Figure 11.

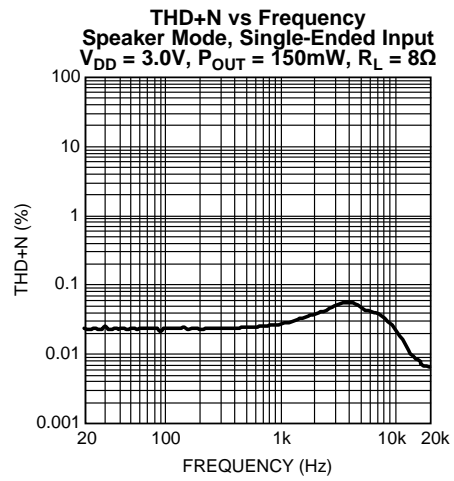

Figure 12.

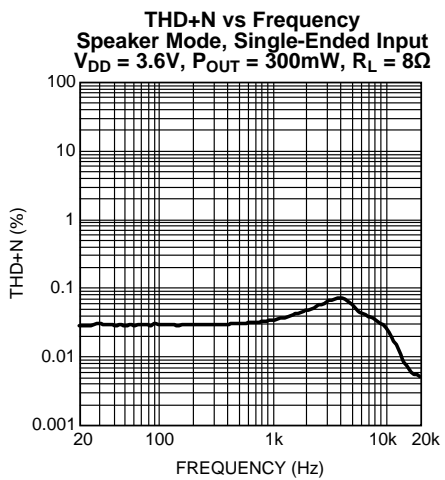

Figure 13.

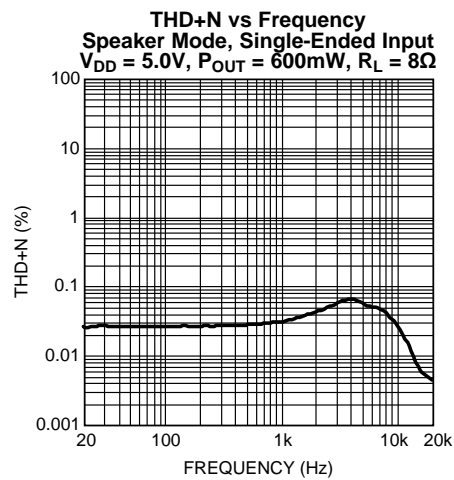

Figure 14.

**TYPICAL PERFORMANCE CHARACTERISTICS (continued)**

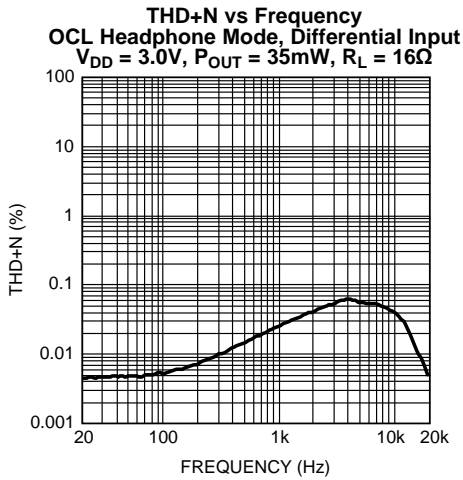

Figure 15.

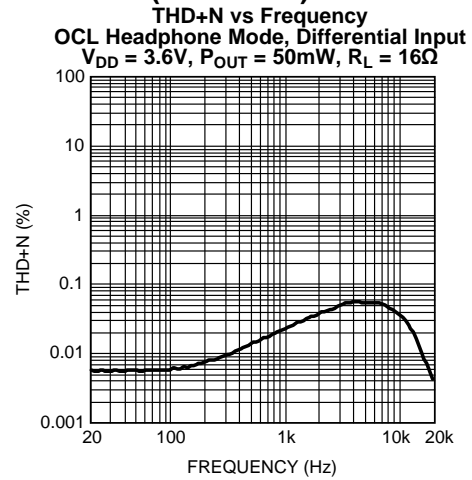

Figure 16.

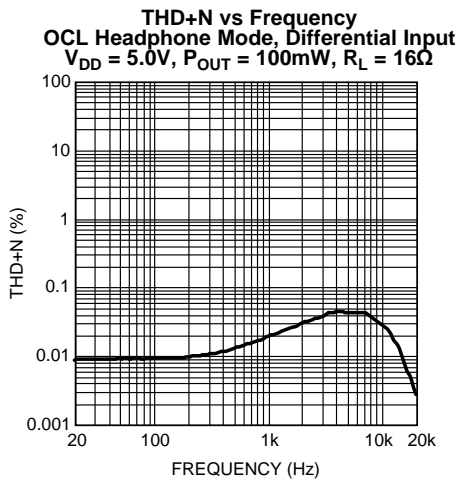

Figure 17.

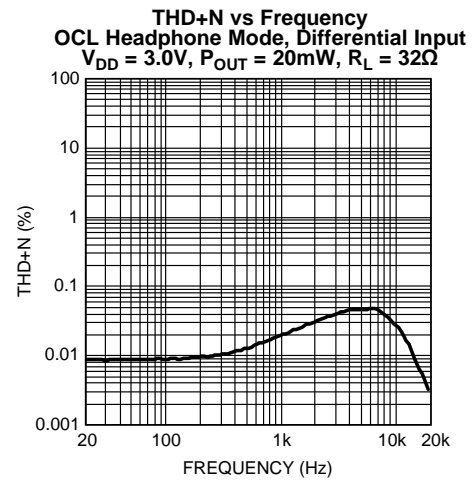

Figure 18.

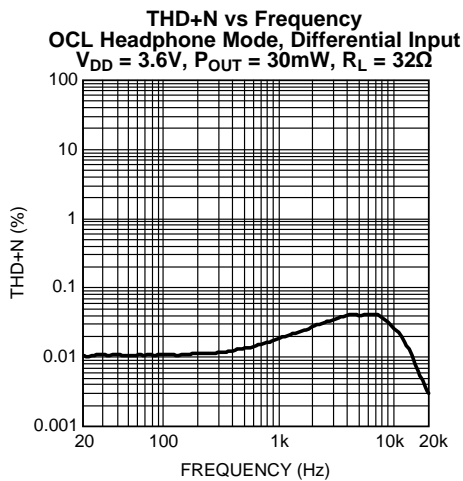

Figure 19.

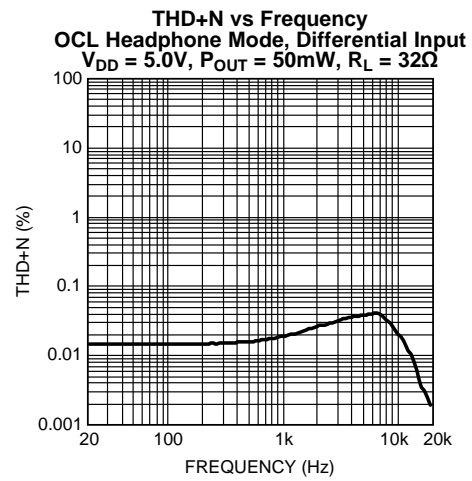

Figure 20.

**TYPICAL PERFORMANCE CHARACTERISTICS (continued)**

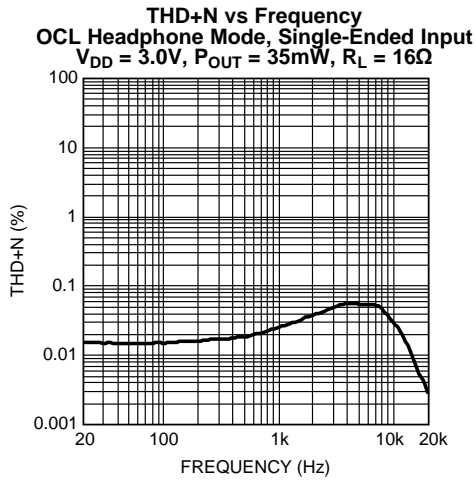

Figure 21.

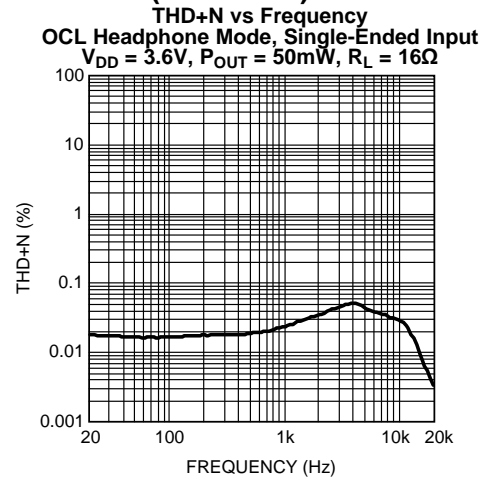

Figure 22.

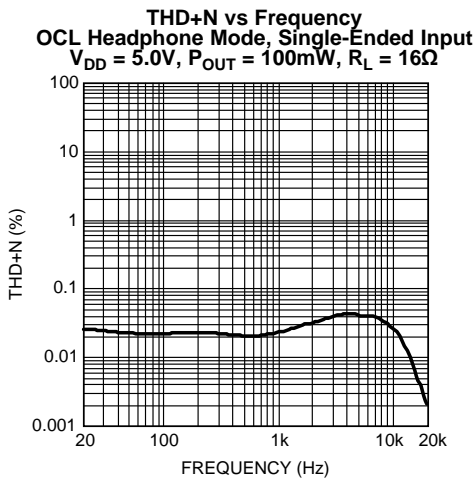

Figure 23.

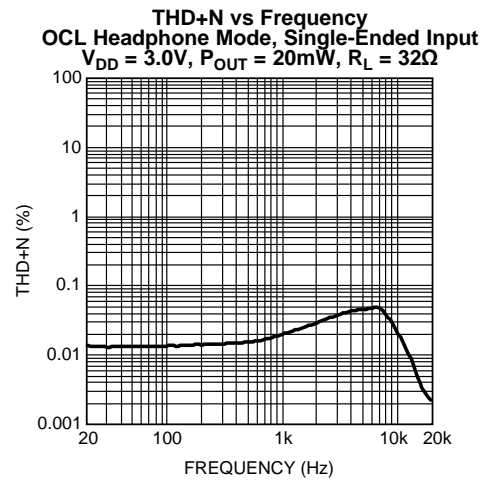

Figure 24.

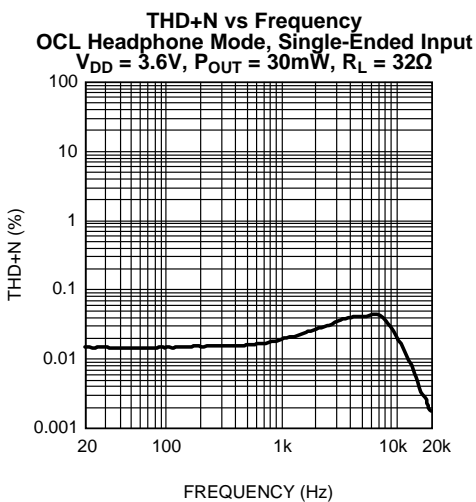

Figure 25.

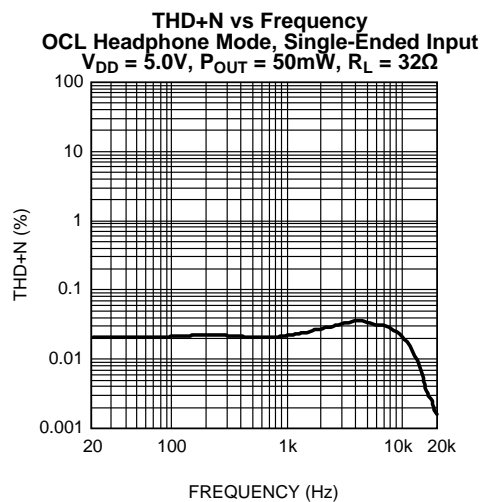

Figure 26.



**TYPICAL PERFORMANCE CHARACTERISTICS (continued)**

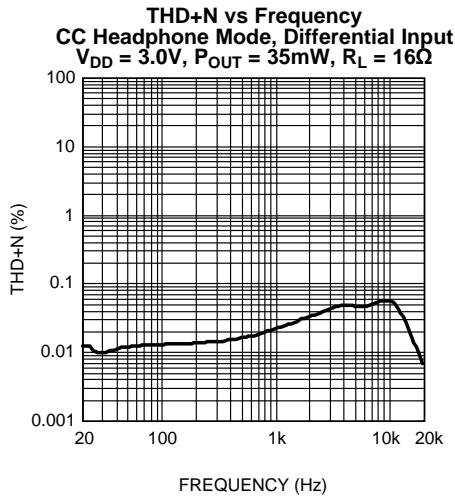

Figure 27.

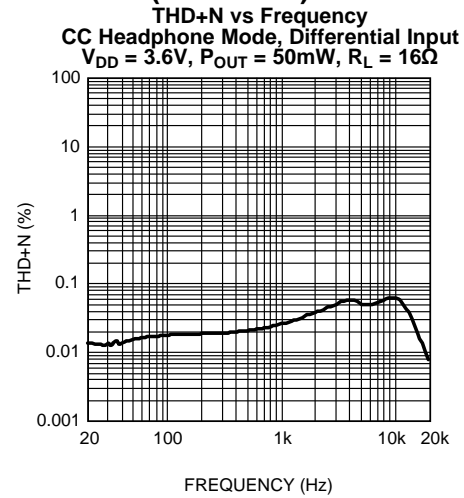

Figure 28.

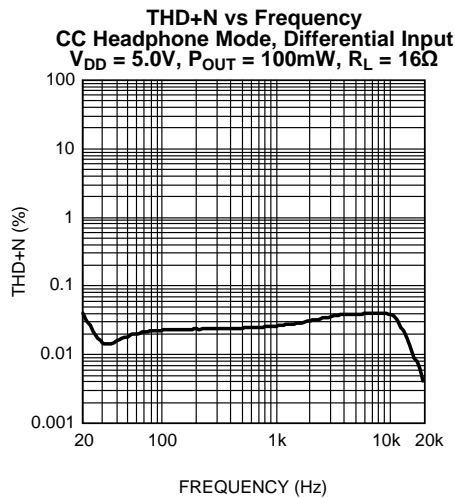

Figure 29.

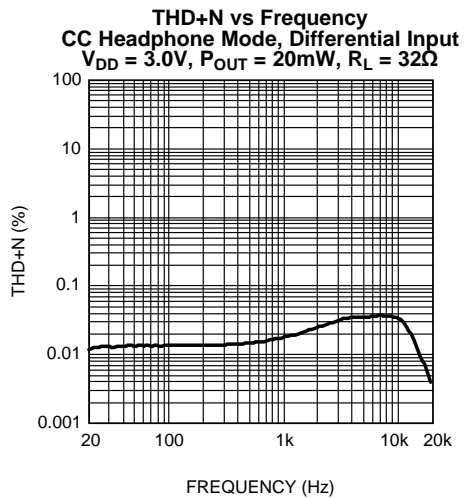

Figure 30.

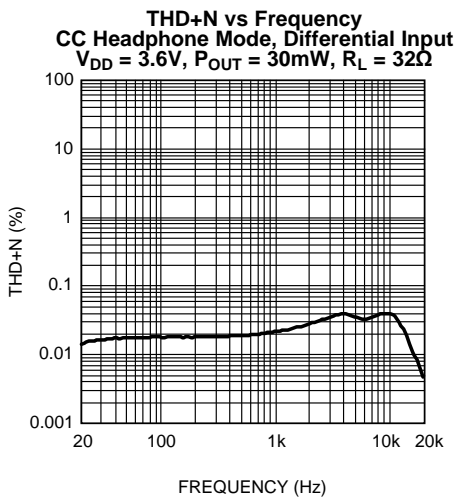

Figure 31.

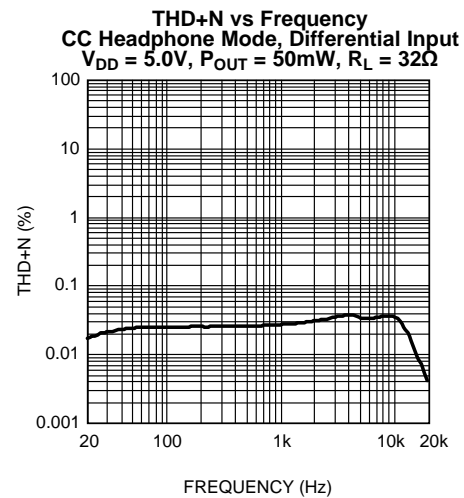

Figure 32.

**TYPICAL PERFORMANCE CHARACTERISTICS (continued)**

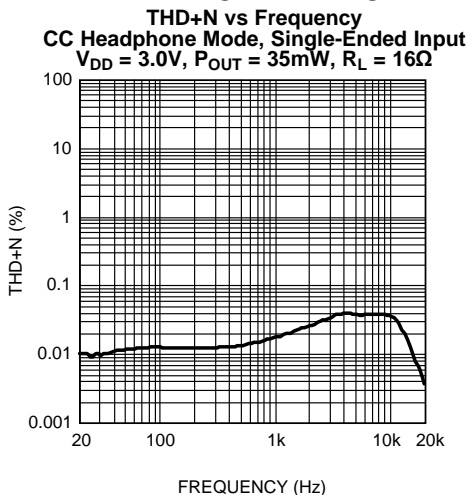

Figure 33.

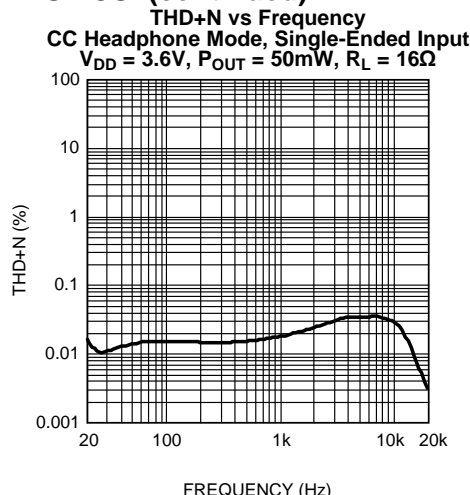

Figure 34.

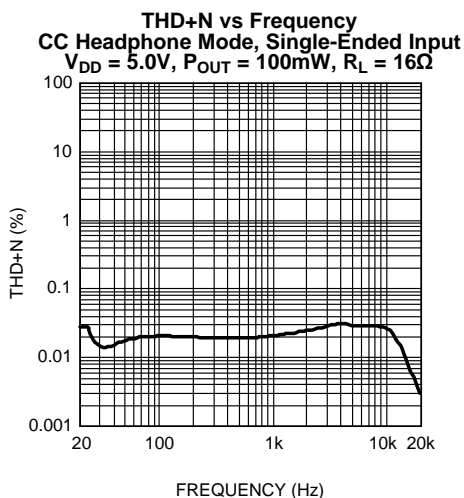

Figure 35.

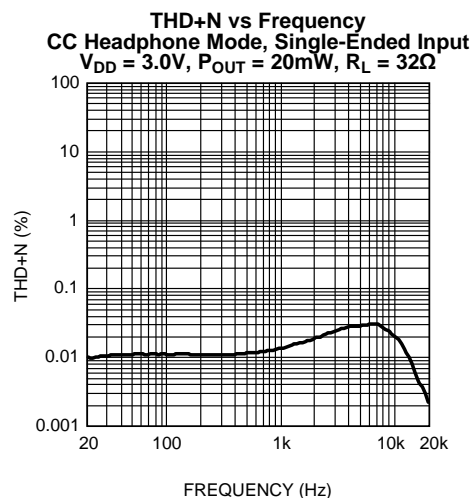

Figure 36.

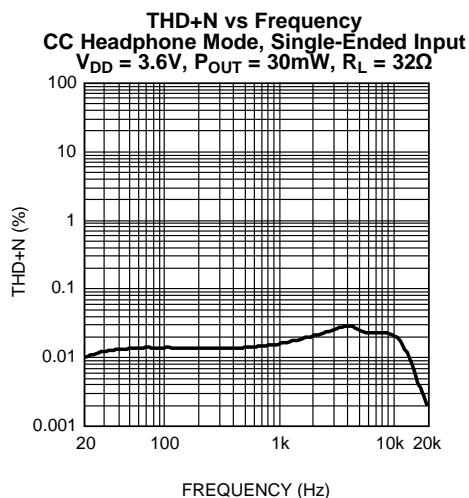

Figure 37.

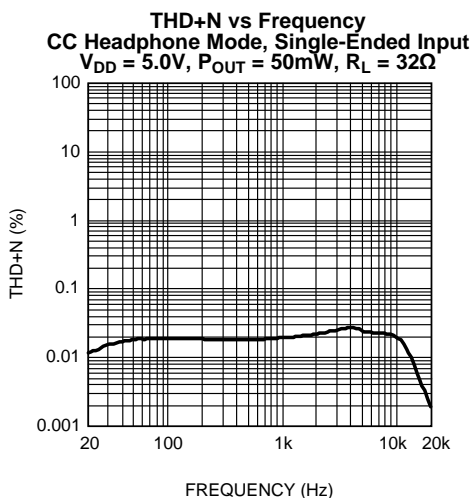

Figure 38.

**TYPICAL PERFORMANCE CHARACTERISTICS (continued)**

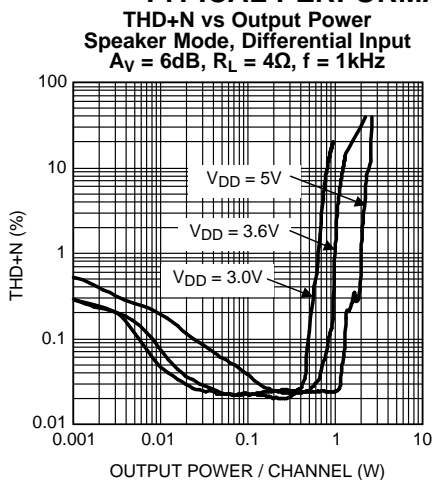

Figure 39.

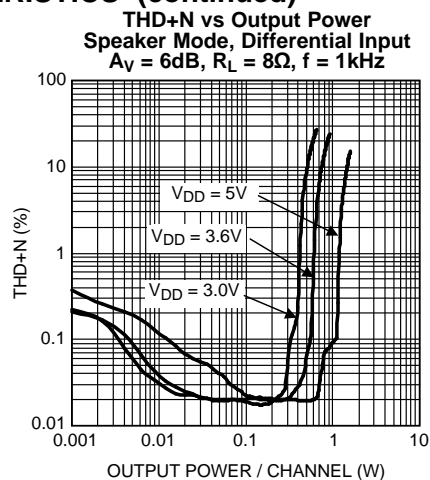

Figure 40.

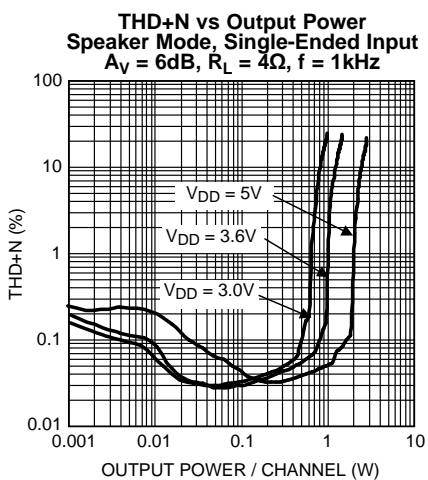

Figure 41.

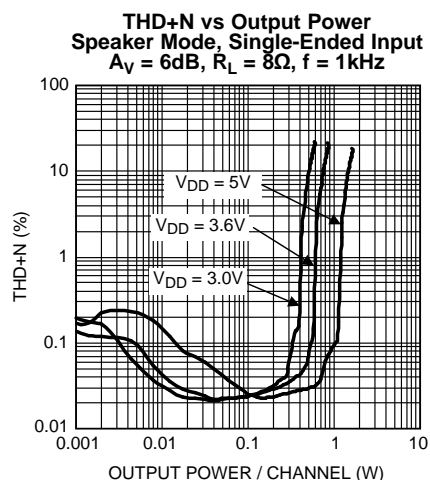

Figure 42.

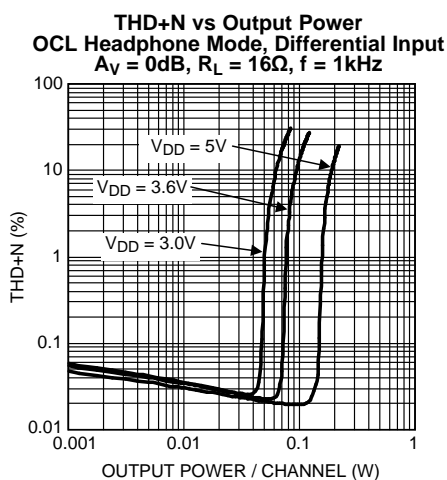

Figure 43.

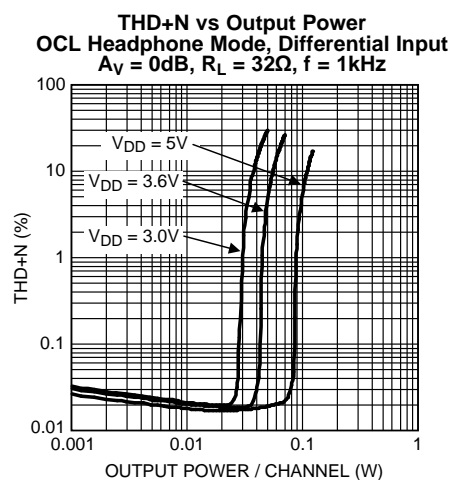

Figure 44.

**TYPICAL PERFORMANCE CHARACTERISTICS (continued)**

**THD+N vs Output Power**  
**OCL Headphone Mode, Single-Ended Input**  
 $A_V = 0\text{dB}$ ,  $R_L = 16\Omega$ ,  $f = 1\text{kHz}$

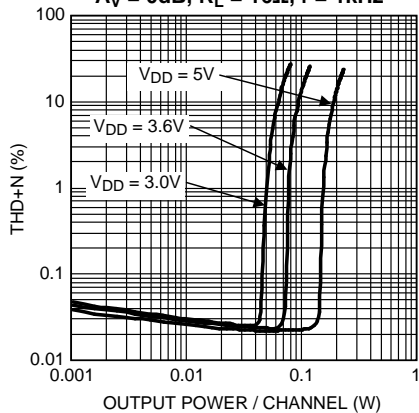

Figure 45.

**THD+N vs Output Power**  
**OCL Headphone Mode, Single-Ended Input**  
 $A_V = 0\text{dB}$ ,  $R_L = 32\Omega$ ,  $f = 1\text{kHz}$

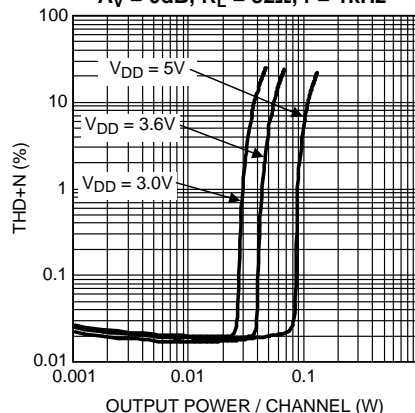

Figure 46.

**THD+N vs Output Power**  
**CC Headphone Mode, Differential Input**  
 $A_V = 0\text{dB}$ ,  $R_L = 16\Omega$ ,  $f = 1\text{kHz}$

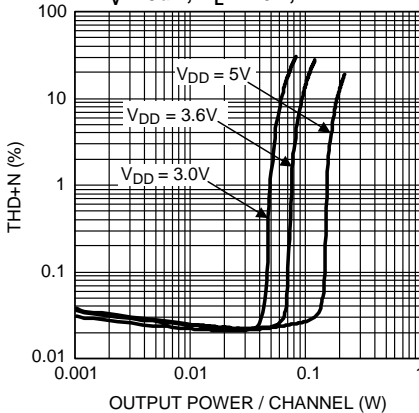

Figure 47.

**THD+N vs Output Power**  
**CC Headphone Mode, Differential Input**  
 $A_V = 0\text{dB}$ ,  $R_L = 32\Omega$ ,  $f = 1\text{kHz}$

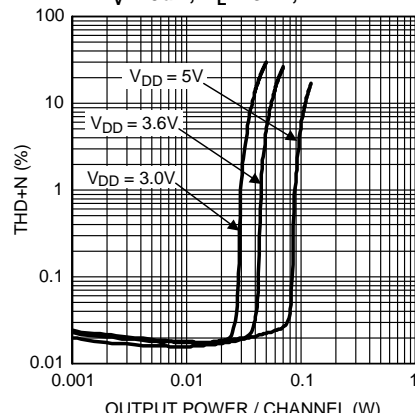

Figure 48.

**THD+N vs Output Power**  
**CC Headphone Mode, Single-Ended Input**  
 $A_V = 0\text{dB}$ ,  $R_L = 16\Omega$ ,  $f = 1\text{kHz}$

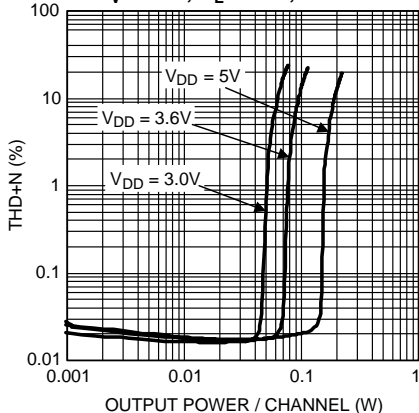

Figure 49.

**THD+N vs Output Power**  
**CC Headphone Mode, Single-Ended Input**  
 $A_V = 0\text{dB}$ ,  $R_L = 32\Omega$ ,  $f = 1\text{kHz}$

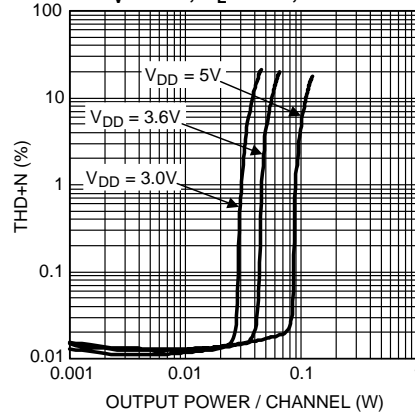

Figure 50.

**TYPICAL PERFORMANCE CHARACTERISTICS (continued)**

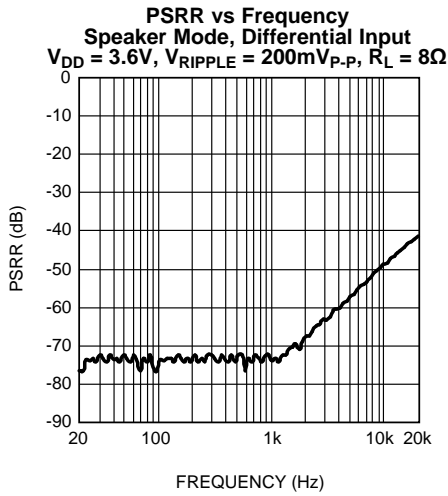

Figure 51.

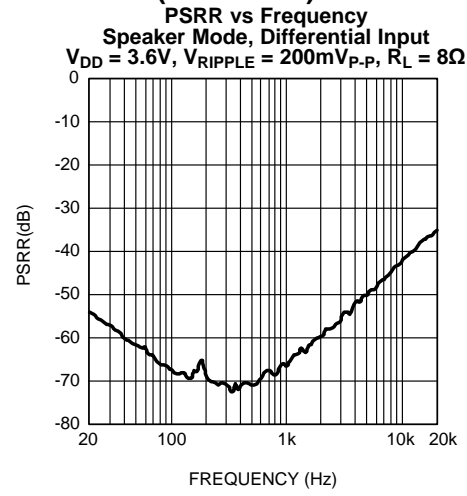

Figure 52.

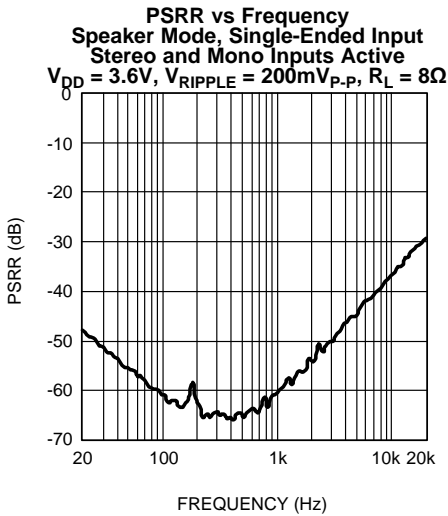

Figure 53.

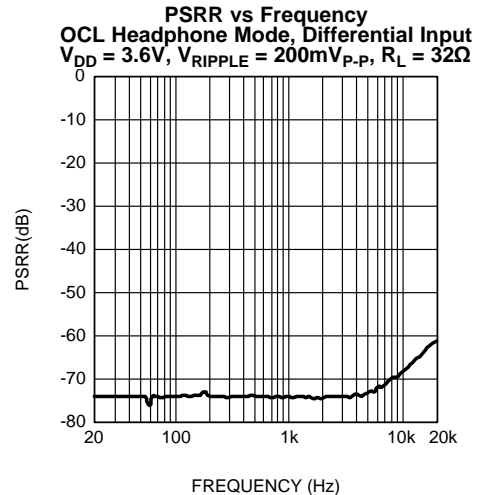

Figure 54.

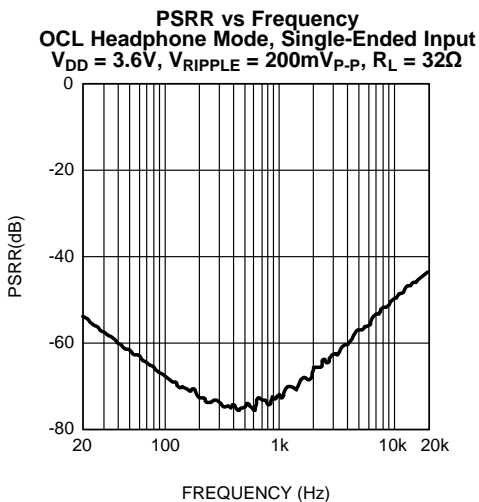

Figure 55.

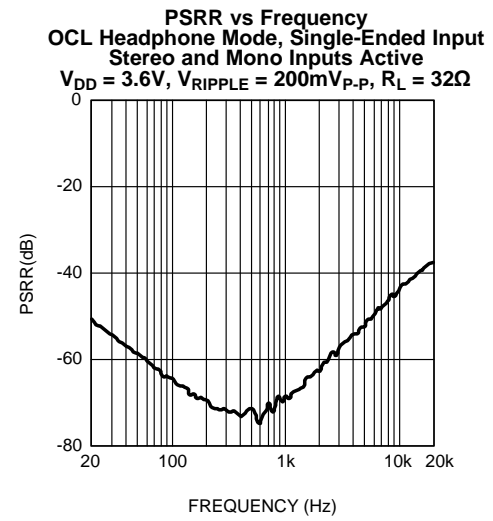

Figure 56.

**TYPICAL PERFORMANCE CHARACTERISTICS (continued)**

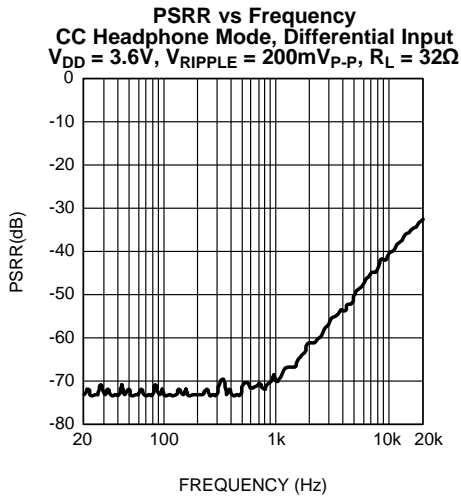

Figure 57.

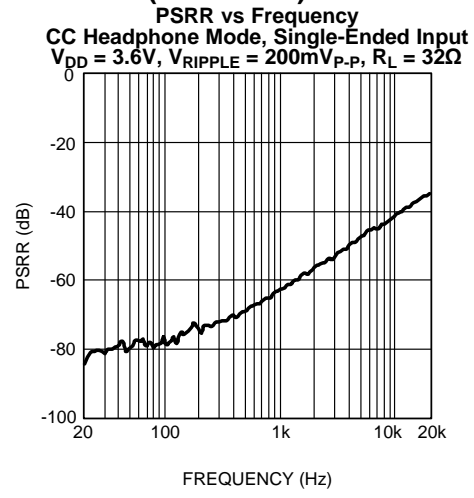

Figure 58.

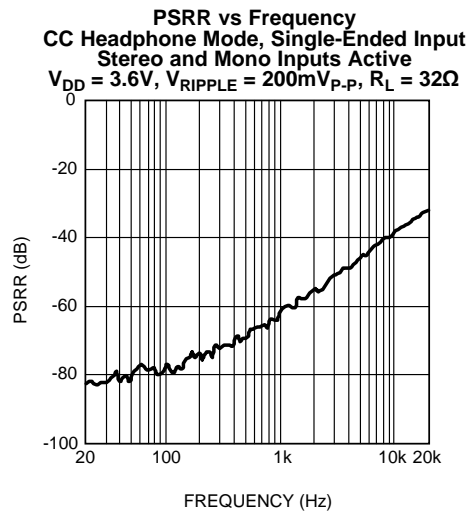

Figure 59.

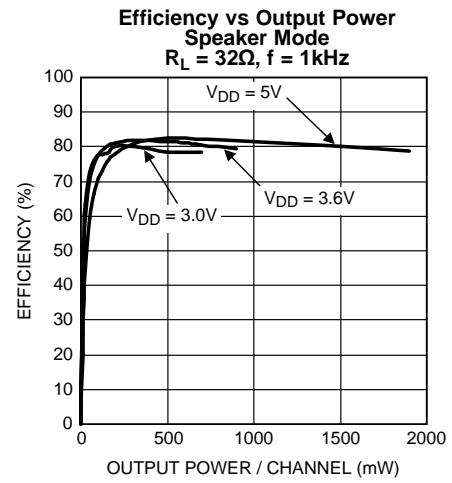

Figure 60.

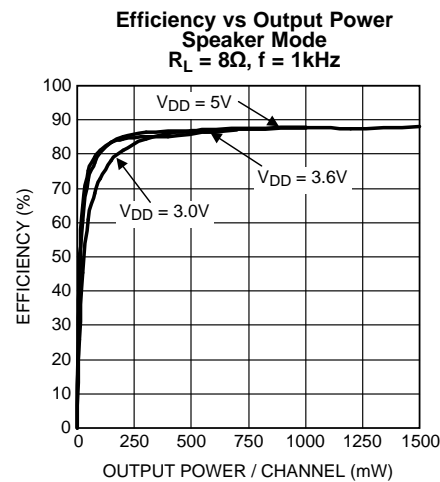

Figure 61.

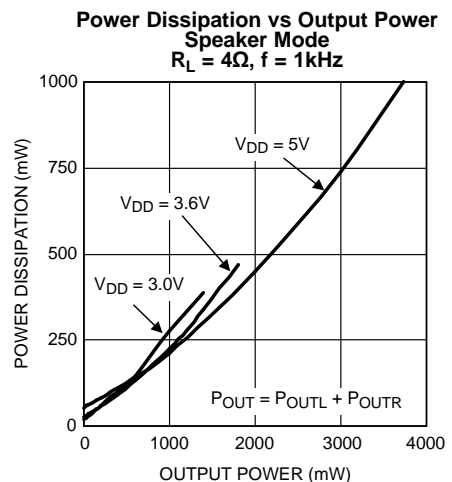
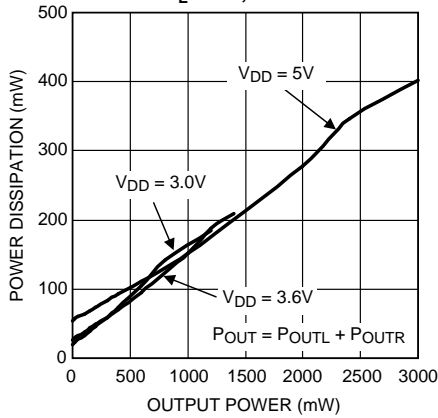

Figure 62.

**TYPICAL PERFORMANCE CHARACTERISTICS (continued)**

**Power Dissipation vs Output Power  
Speaker Mode  
 $R_L = 8\Omega, f = 1\text{kHz}$**



**Figure 63.**

**Power Dissipation vs Output Power  
OCL Headphone Mode  
 $R_L = 16\Omega, f = 1\text{kHz}$**

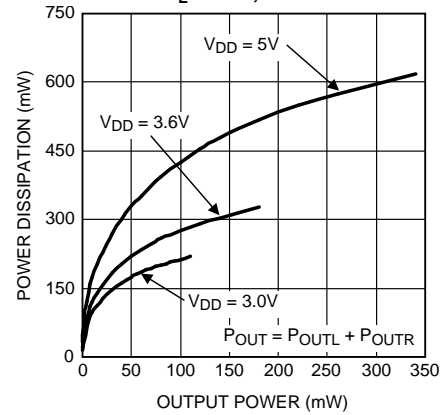

**Figure 64.**

**Power Dissipation vs Output Power  
OCL Headphone Mode  
 $R_L = 32\Omega, f = 1\text{kHz}$**

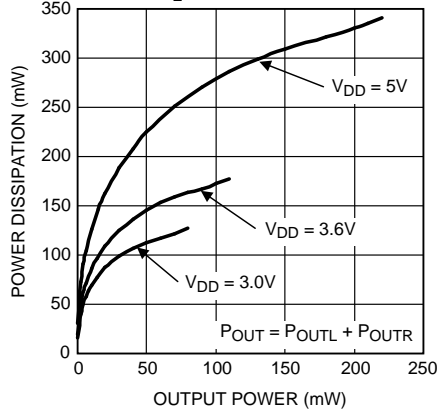

**Figure 65.**

**Power Dissipation vs Output Power  
CC Headphone Mode  
 $R_L = 16\Omega, f = 1\text{kHz}$**

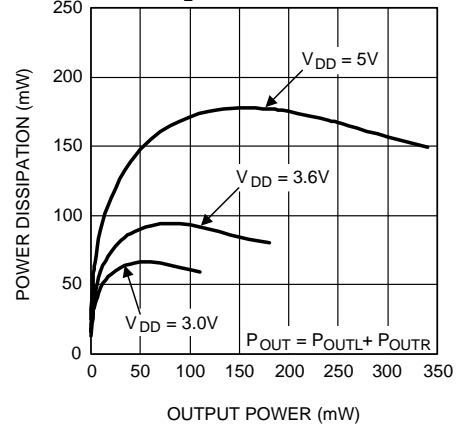

**Figure 66.**

**Power Dissipation vs Output Power  
CC Headphone Mode  
 $R_L = 32\Omega, f = 1\text{kHz}$**

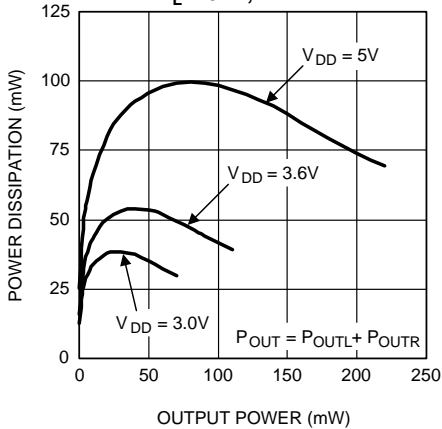

**Figure 67.**

**Output Power vs Supply Voltage  
Speaker Mode  
 $R_L = 4\Omega, f = 1\text{kHz}$**

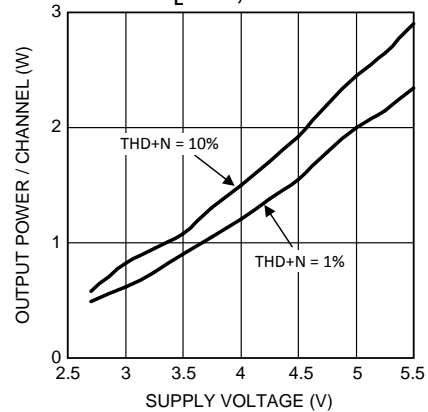

**Figure 68.**

**TYPICAL PERFORMANCE CHARACTERISTICS (continued)**

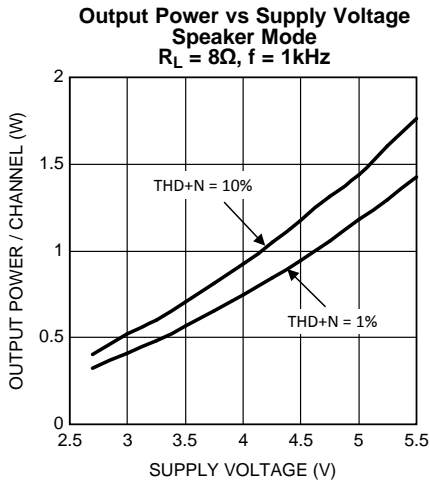

Figure 69.

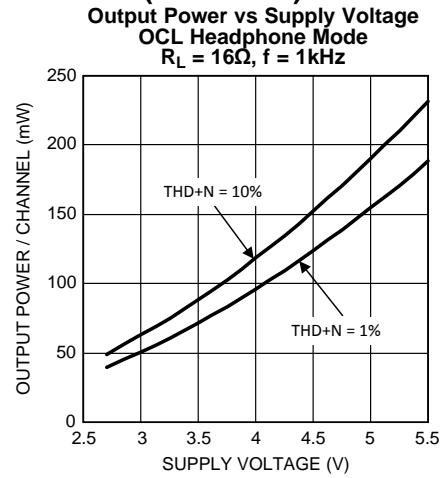

Figure 70.

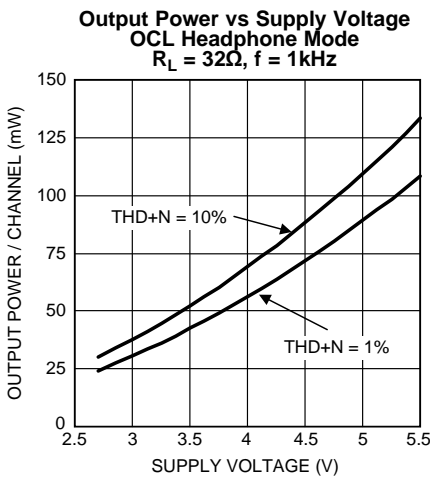

Figure 71.

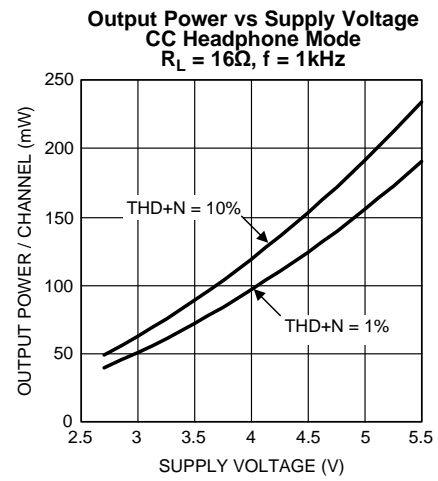

Figure 72.

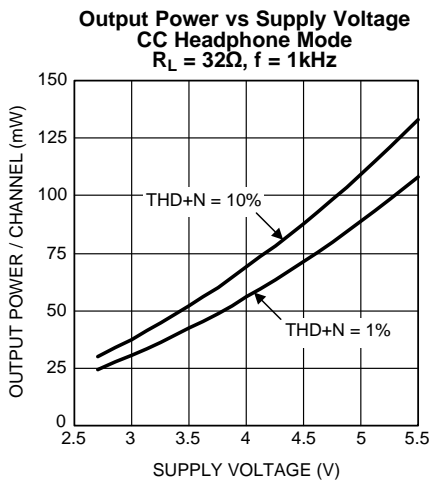

Figure 73.

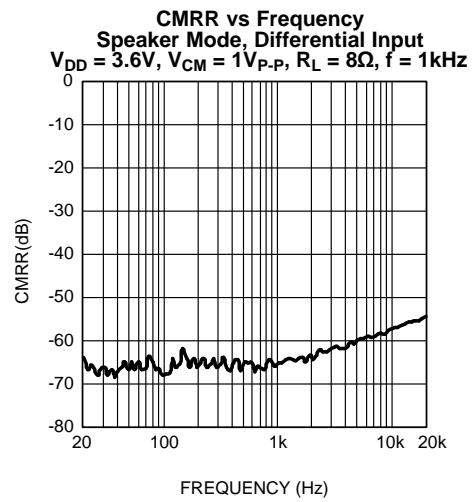

Figure 74.



**TYPICAL PERFORMANCE CHARACTERISTICS (continued)**

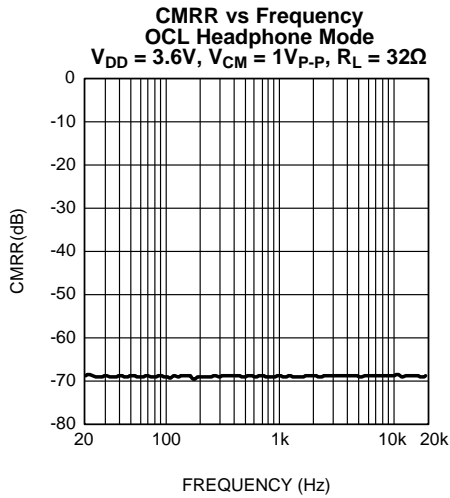

Figure 75.

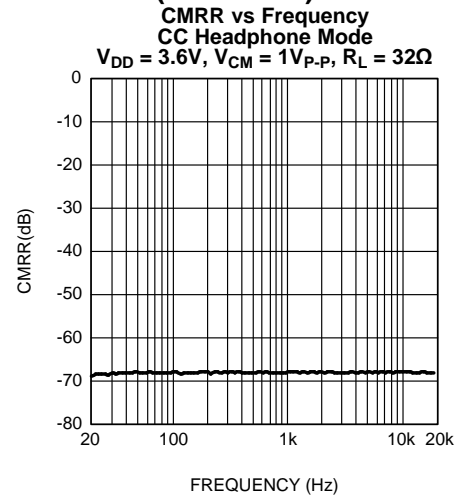

Figure 76.

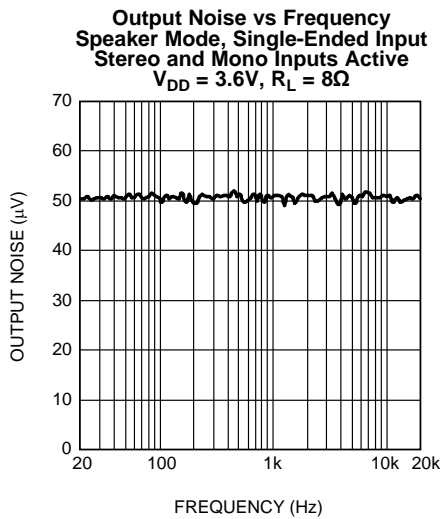

Figure 77.

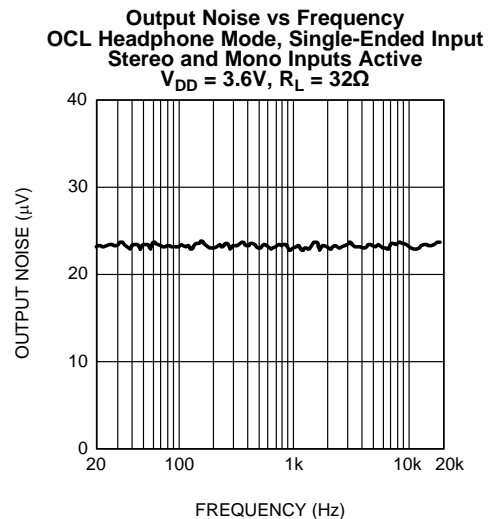

Figure 78.

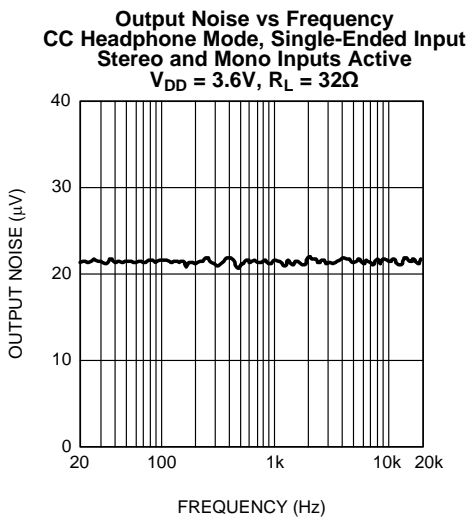

Figure 79.

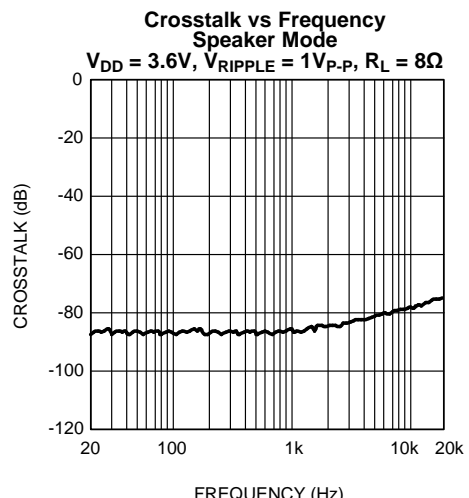

Figure 80.

**TYPICAL PERFORMANCE CHARACTERISTICS (continued)**

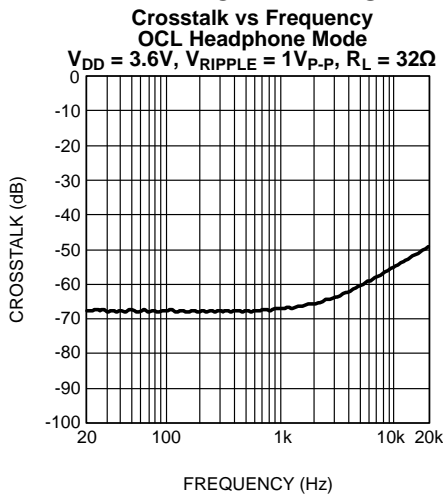

Figure 81.

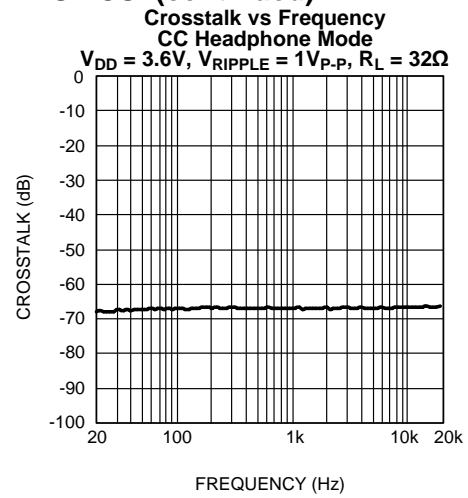

Figure 82.

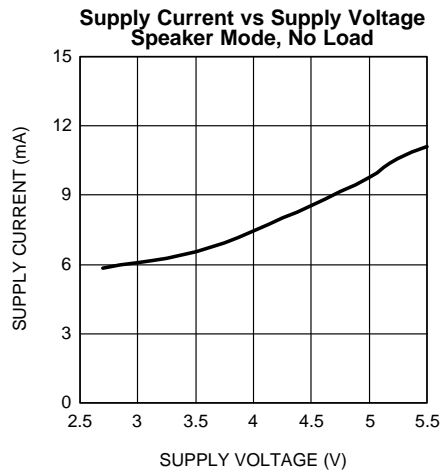

Figure 83.

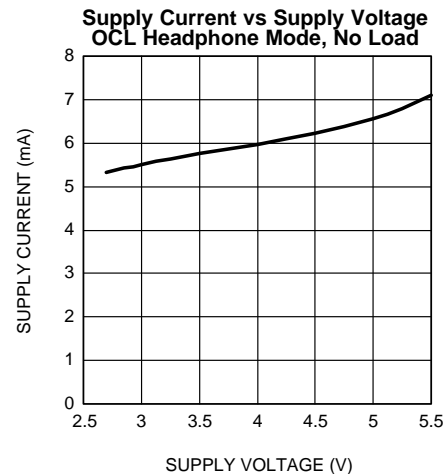

Figure 84.

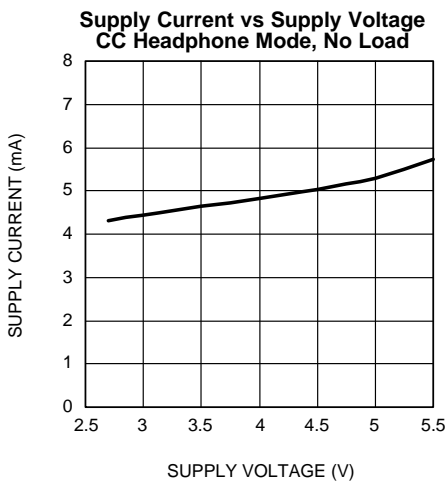

Figure 85.

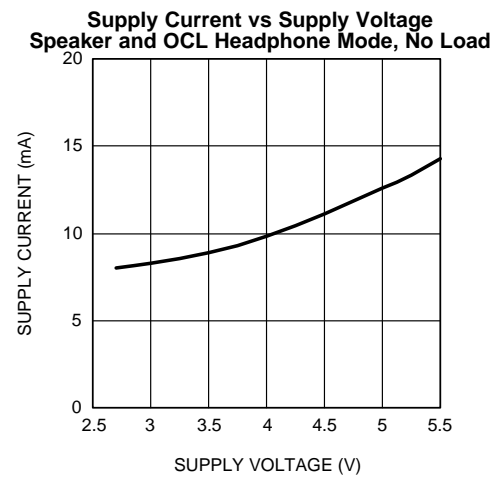

Figure 86.

**TYPICAL PERFORMANCE CHARACTERISTICS (continued)**

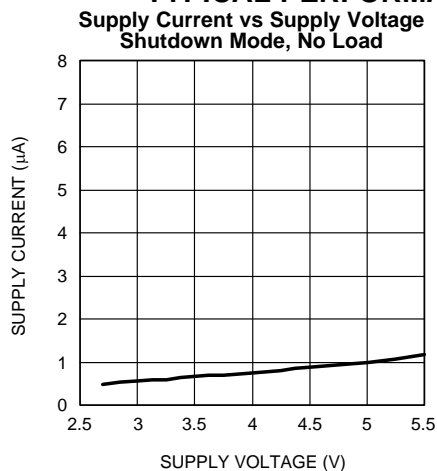

Figure 87.

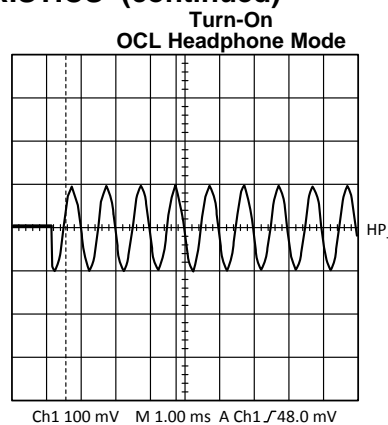

Figure 88.

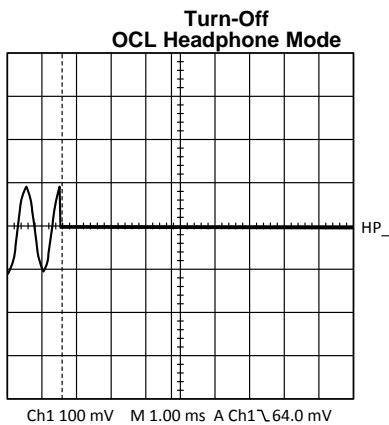

Figure 89.

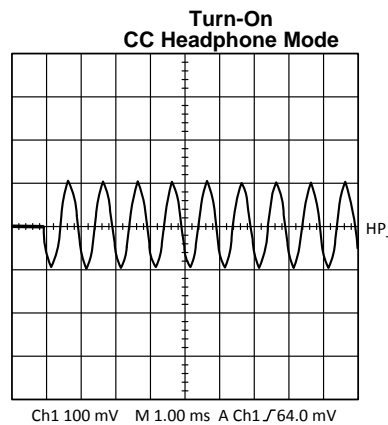

Figure 90.

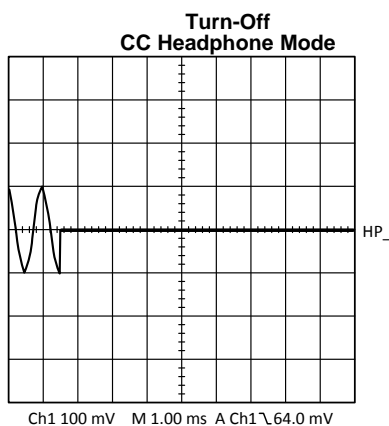

Figure 91.

## APPLICATION INFORMATION

### I<sup>2</sup>C COMPATIBLE INTERFACE

The LM4949 is controlled through an I<sup>2</sup>C compatible serial interface that consists of two wires; clock (SCL) and data (SDA). The clock line is uni-directional. The data line is bi-directional (open-collector) although the LM4949 does not write to the I<sup>2</sup>C bus. The maximum clock frequency specified by the I<sup>2</sup>C standard is 400kHz.

To avoid an address conflict with another device on the I<sup>2</sup>C bus, the LM4949 address is determined by the ADR pin, the state of ADR determines address bit A1 (Table 2). When ADR = 0, the address is 1111 1000. When ADR = 1 the device address is 1111 1010.

**Table 2. Device Address**

ADR	A7	A6	A5	A4	A3	A2	A1	A0
X	1	1	1	1	1	0	X	0
0	1	1	1	1	1	0	0	0
1	1	1	1	1	1	0	1	0

### BUS FORMAT

The I<sup>2</sup>C bus format is shown in Figure 92. The “start” signal is generated by lowering the data signal while the clock is high. The start signal alerts all devices on the bus that a device address is being written to the bus.

The 8-bit device address is written to the bus next, most significant bit first. The data is latched in on the rising edge of the clock. Each address bit must be stable while the clock is high.

After the last address bit is sent, the master device releases the data line, during which time, an acknowledge clock pulse is generated. If the LM4949 receives the address correctly, then the LM4949 pulls the data line low, generating an acknowledge bit (ACK).

Once the master device has registered the ACK bit, the 8-bit register address/data word is sent. Each data bit should be stable while the clock level is high. After the 8-bit word is sent, the LM4949 sends another ACK bit. Following the acknowledgment of the data word, the master device issues a “stop” bit, allowing SDA to go high while the clock is high.

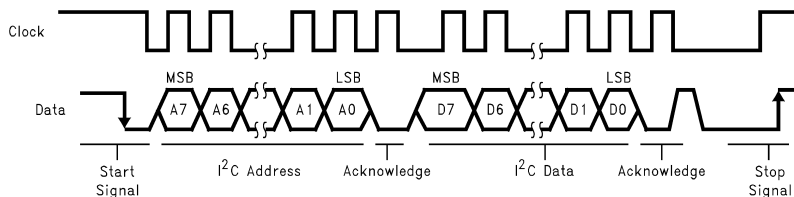

**Figure 92. I<sup>2</sup>C Bus Format**

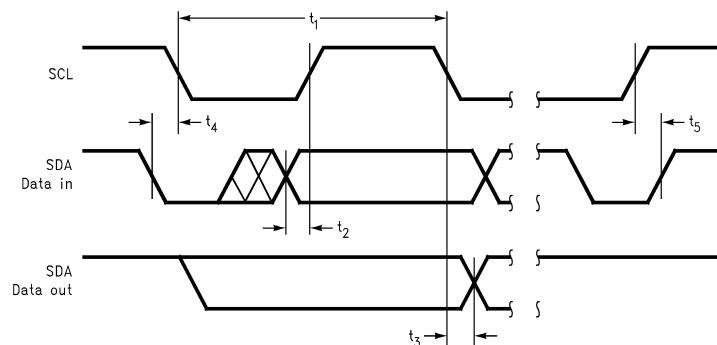

**Figure 93. I<sup>2</sup>C Timing Diagram**

**Table 3. I<sup>2</sup>C Control Registers**

REGISTER	REGISTER NAME	D7	D6	D5	D4	D3	D2	D1	D0
0.0	Shutdown Control	0	0	0	0	0	OCL_LGC <sup>(1)</sup>	OCL <sup>(1)</sup>	PWR_ON
0.1	Stereo Input Mode Control	0	0	0	1	L1_INSEL	L2_INSEL	SDB_HPSEL	SDB_MUXSEL
1	Speaker Output Mux Control	0	0	1	LS_XSEL	LSR_MSEL	LSR_SSEL	LSL_MSEL	LSL_SSEL
2	Headphone Output Mux Control	0	1	0	HP_XSEL	HPR_MSEL	HPR_SSEL	HPL_MSEL	HPL_SSEL
3.0	Output On/Off Control	0	1	1	0	HPR_ON	HPL_ON	LSR_ON	LSL_ON
3.1	Reserved	0	1	1	1	RESERVED	RESERVED	RESERVED	RESERVED
4.0	Headphone Output Stage Gain Control	1	0	0	0	HPG1	HPG0	RESERVED	RESERVED
4.1	Speaker Output Stage Gain Control	1	0	0	1	LSRG1	LSRG0	LSLG1	LSLG0
5	Mono Input Gain Control	1	0	1	MG4	MG3	MG2	MG1	MG0
6	Left Input Gain Control	1	1	0	LG4	LG3	LG2	LG1	LG0
7	Right Input Gain Control	1	1	1	RG4	RG3	RG2	RG1	RG0

(1) OCL\_LGC = 1 and OCL = 1 at the same time is not allowed.

## GENERAL AMPLIFIER FUNCTION

### Class D Amplifier

The LM4949 features a high-efficiency, filterless, Class D stereo amplifier. The LM4949 Class D amplifiers feature a filterless modulation scheme, the differential outputs of each channel switch at 300kHz, from  $V_{DD}$  to GND. When there is no input signal applied, the two outputs ( $_{LS+}$  and  $_{LS-}$ ) switch with a 50% duty cycle, with both outputs in phase. Because the outputs of the LM4949 are differential, the two signals cancel each other. This results in no net voltage across the speaker, thus no load current during the idle state, conserving power.

When an input signal is applied, the duty cycle (pulse width) changes. For increasing output voltages, the duty cycle of  $_{LS+}$  increases, while the duty cycle of  $_{LS-}$  decreases. For decreasing output voltages, the converse occurs, the duty cycle of  $_{LS-}$  increases while the duty cycle of  $_{LS+}$  decreases. The difference between the two pulse widths yields the differential output voltage.

### Headphone Amplifier

The LM4949 headphone amplifier features three different operating modes, output capacitorless (OCL), capacitor-coupled (CC), and external amplifier mode.

The OCL architecture eliminates the bulky, expensive output coupling capacitors required by traditional headphone amplifiers. The LM4949 headphone section uses three amplifiers. Two amplifiers drive the headphones while the third (VOC) is set to the internally generated bias voltage (typically  $V_{DD}/2$ ). The third amplifier is connected to the return terminal of the headphone jack. In this configuration, the signal side of the headphones are biased to  $V_{DD}/2$ , the return is biased to  $V_{DD}/2$ , thus there is no net DC voltage across the headphone, eliminating the need for an output coupling capacitor. Removing the output coupling capacitors from the headphone signal path reduces component count, reducing system cost and board space consumption, as well as improving low frequency performance.

In OCL mode, the headphone return sleeve is biased to  $V_{DD}/2$ . When driving headphones, the voltage on the return sleeve is not an issue. However, if the headphone output is used as a line out, the  $V_{DD}/2$  can conflict with the GND potential that a line-in would expect on the return sleeve. When the return of the headphone jack is connected to GND, the VOC amplifier of the LM4949 detects an output short circuit condition and is disabled, preventing damage to the LM4949, and allowing the headphone return to be biased at GND.

### Capacitor Coupled Headphone Mode

In capacitor coupled (CC) mode, the VOC pin is disabled, and the headphone outputs are coupled to the jack through series capacitors, allowing the headphone return to be connected to GND (Figure 94). In CC mode, the LM4949 requires output coupling capacitors to block the DC component of the amplifier output, preventing DC current from flowing to the load. The output capacitor and speaker impedance form a high pass filter with a -3dB roll-off determined by:

$$f_{-3dB} = 1 / 2\pi R_L C_{OUT} \quad (1)$$

Where  $R_L$  is the headphone impedance, and  $C_{OUT}$  is the output coupling capacitor. Choose  $C_{OUT}$  such that  $f_{-3dB}$  is well below the lowest frequency of interest. Setting  $f_{-3dB}$  too high results in poor low frequency performance. Select capacitor dielectric types with low ESR to minimize signal loss due to capacitor series resistance and maximize power transfer to the load.

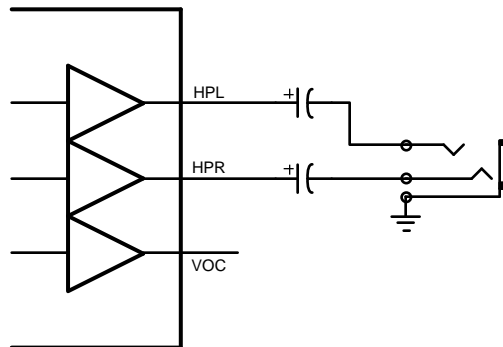

Figure 94. Capacitor Coupled Headphone Mode

### External Headphone Amplifier

The LM4949 features the ability to drive and control a separate headphone amplifier for applications that require a True Ground headphone output (Figure 95). Configure the LM4949 into external headphone amplifier mode by setting bit D2 (OCL\_LGC) in register 0.0 to 1 and bit D1 (OCL) to 0. In this mode the VOC output becomes a logic output used to drive the shutdown input of the external amplifier. The output level of VOC is controlled by bits D1 (SDB\_HPSEL) and D2 (SDB\_MUXSEL) in register 0.1. SDB\_MUXSEL determines the source of the VOC control signal. With SDB\_MUXSEL = 0, the VOC signal comes from the internal start-up circuitry of the LM4949. This allows the external headphone amplifier to be turned on and off simultaneously with the LM4949. When SDB\_MUXSEL = 1, the VOC signal comes from the I<sup>2</sup>C bus, bit D1. With SDB\_HPSEL = 0, VOC is a logic low, with SDB\_HPSEL = 1, VOC is a logic high.

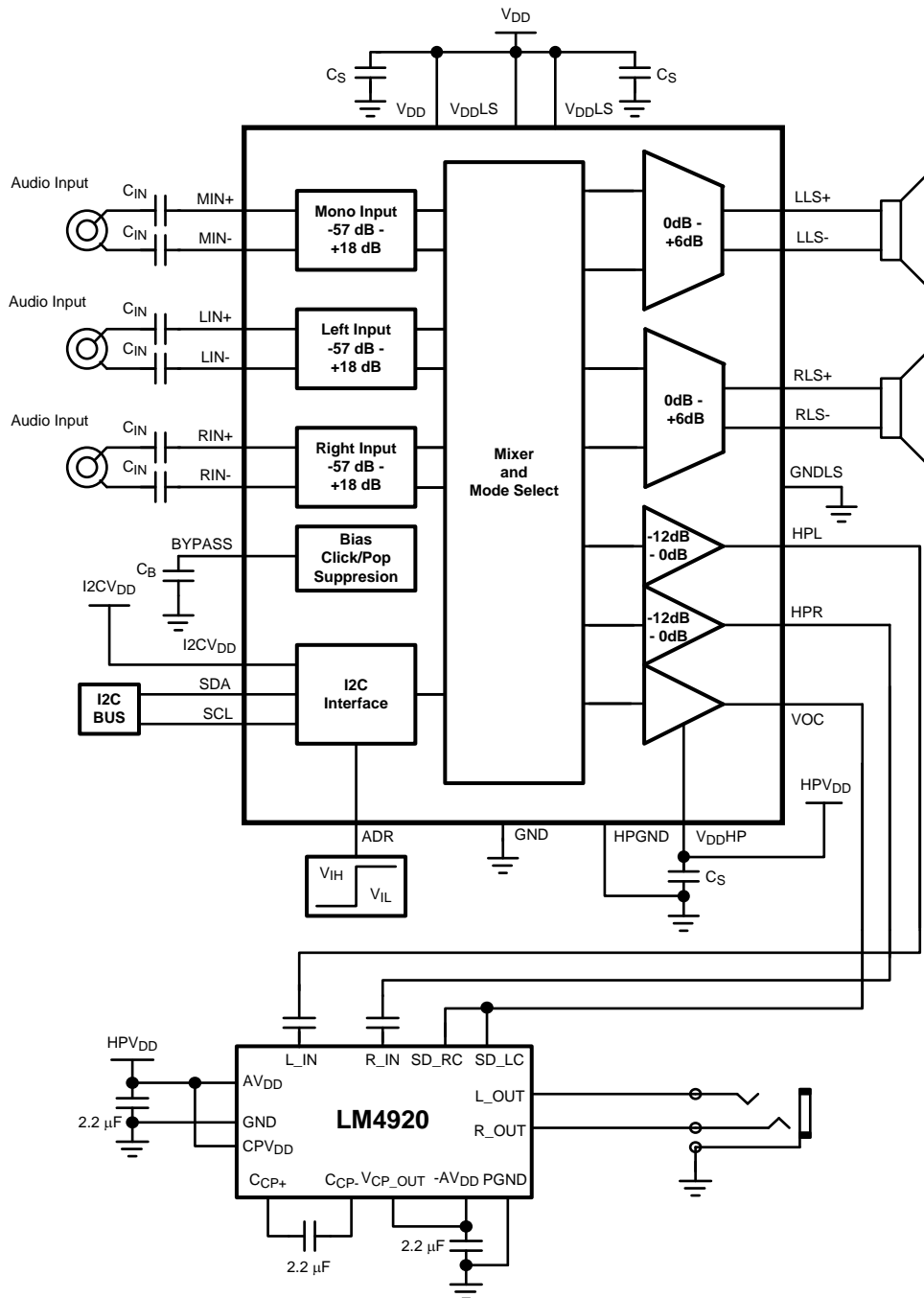

Figure 95. Driving an External Headphone Amplifier

### Single-Ended Input

The left and right stereo inputs of the LM4949 can be configured for single-ended sources (Figure 96). In single-ended input mode, the LM4949 can accept up to 4 different single-ended audio sources. Set bits L1\_INSEL = 1 and L2\_INSEL = 0 to use the RIN+ and LIN+ inputs. Set L1\_INSEL = 0 and L2\_INSEL = 1 to use the RIN- and LIN- inputs. Set L1\_INSEL = L2\_INSEL = 1 to use both input pairs. Table 4 shows the single ended input combinations.

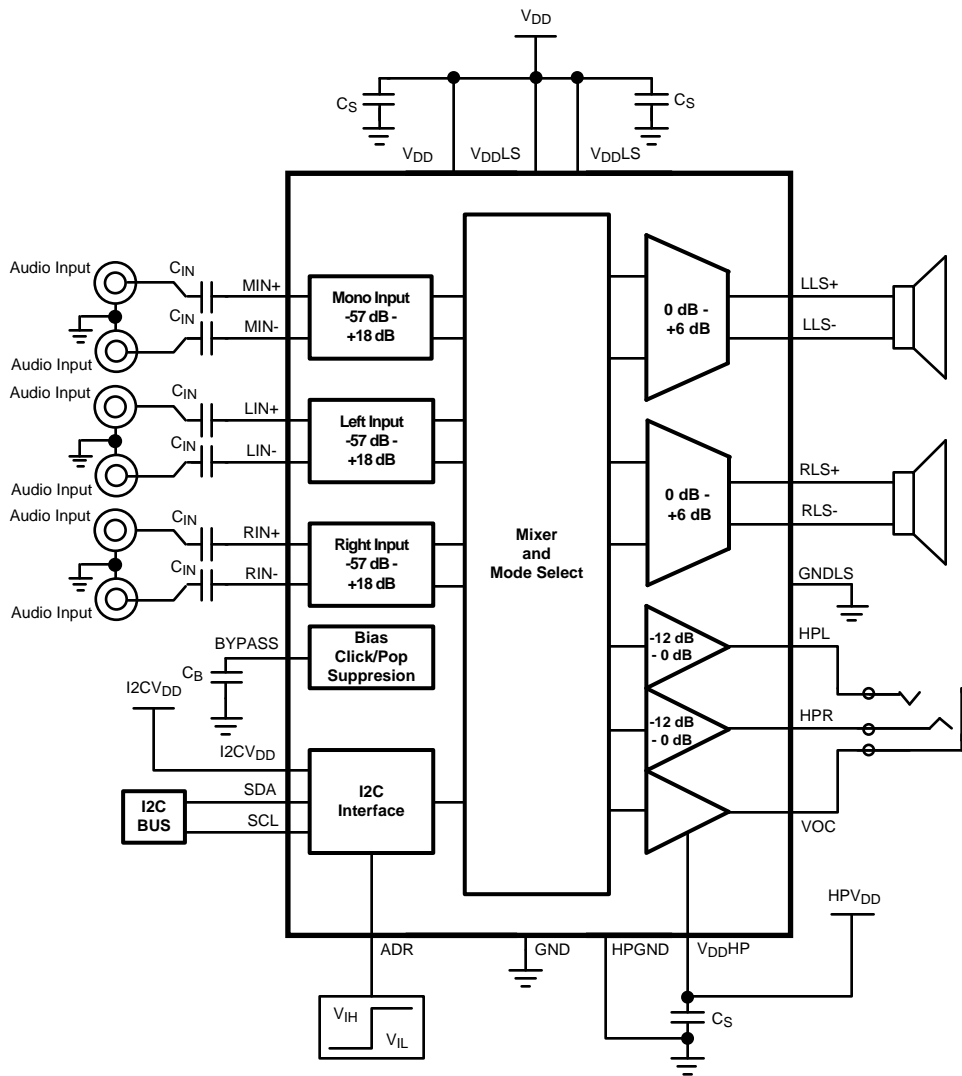

Figure 96. Single-Ended Input Configuration

Table 4. Single-Ended Stereo Input Modes

INPUT MODE	L1_INSEL	L2_INSEL	INPUT DESCRIPTION
0	0	0	Fully Differential Input Mode
1	0	1	Single-ended input. RIN- and LIN- selected
2	1	0	Single-ended input. RIN+ and LIN+ selected
3	1	1	Single-ended input. RIN+ mixed with RIN- and LIN+ mixed with LIN-

**Input Mixer / Multiplexer**

The LM4949 includes a comprehensive mixer/multiplexer controlled through the I2C interface. The mixer/multiplexer allows any input combination to appear on any output of the LM4949. Control bits LSR\_SSEL and LSL\_SSEL (loudspeakers), and HPR\_SSEL and HPL\_SSEL (headphones) select the individual stereo input channels; for example, LSR\_SSEL = 1 outputs the right channel stereo input on the right channel loudspeaker, while LSL\_SSEL = 1 outputs the left channel stereo input on the left channel loudspeaker. Control bits



LSR\_MSEL and LSL\_MSEL (loudspeaker), and HPR\_MSEL and HPR\_LSEL (headphones) direct the mono input to the selected output. Setting HPR\_MSEL = 1 outputs the mono input on the right channel headphone. Control bits LS\_XSEL (loudspeaker) and HP\_XSEL (headphone) selects both stereo input channels and directs the signals to the opposite outputs, for example, LS\_XSEL = 1 outputs the right channel stereo input on the left channel loudspeaker, while the left channel stereo input is output on the right channel loudspeaker. Setting \_\_XSEL = selects both stereo inputs simultaneously, unlike the \_\_SSEL controls which select the stereo input channels individually.

Multiple input paths can be selected simultaneously. Under these conditions, the selected inputs are mixed together and output on the selected channel. Table 5 and Table 6 show how the input signals are mixed together for each possible input selection combination.

**Table 5. Loudspeaker Multiplexer Control**

LS MODE	LS_XSEL	LSR_MSEL/ LSL_MSEL	LSR_SSEL/ LSL_SSEL	LEFT CHANNEL OUTPUT	RIGHT CHANNEL OUTPUT
0		0	0	MUTE	MUTE
1	0	1	0	MONO	MONO
2	0	0	1	LEFT (DIFF)/ /LIN+/LIN-/ (LIN+ - LIN-)	RIGHT (DIFF)/ /RIN+/RIN-/ (RIN+ - RIN-)
3	0	1	1	MONO + LEFT (DIFF)/ /LIN+/LIN-/ (LIN+ - LIN-)	MONO + RIGHT (DIFF)/ /RIN+/RIN-/ (RIN+ - RIN-)
4	1	0	1	LEFT (DIFF)/ /LIN+/LIN-/ (LIN+ - LIN-) + RIGHT (DIFF)/ /RIN+/RIN-/ (RIN+ - RIN-)	LEFT (DIFF)/ /LIN+/LIN-/ (LIN+ - LIN-) + RIGHT (DIFF)/ /RIN+/RIN-/ (RIN+ - RIN-)
5	1	1	1	MONO + LEFT (DIFF)/ /LIN+/LIN-/ (LIN+ - LIN-) + RIGHT (DIFF)/ /RIN+/RIN-/ (RIN+ - RIN-)	MONO + LEFT (DIFF)/ /LIN+/LIN-/ (LIN+ - LIN-) + RIGHT (DIFF)/ /RIN+/RIN-/ (RIN+ - RIN-)

**Table 6. Headphone Multiplexer Control**

HP MODE	HP_XSEL	HPR_MSEL/ HPL_MSEL	HPR_SSEL/ HPL_SSEL	LEFT CHANNEL OUTPUT	RIGHT CHANNEL OUTPUT
0		0	0	MUTE	MUTE
1	0	1	0	MONO	MONO
2	0	0	1	LEFT (DIFF)/ /LIN+/LIN-/ (LIN+ - LIN-)	RIGHT (DIFF)/ /RIN+/RIN-/ (RIN+ - RIN-)
3	0	1	1	MONO + LEFT (DIFF)/ /LIN+/LIN-/ (LIN+ - LIN-)	MONO + RIGHT (DIFF)/ /RIN+/RIN-/ (RIN+ - RIN-)
4	1	0	1	LEFT (DIFF)/ /LIN+/LIN-/ (LIN+ - LIN-) + RIGHT (DIFF)/ /RIN+/RIN-/ (RIN+ - RIN-)	LEFT (DIFF)/ /LIN+/LIN-/ (LIN+ - LIN-) + RIGHT (DIFF)/ /RIN+/RIN-/ (RIN+ - RIN-)
5	1	1	1	MONO + LEFT (DIFF)/ /LIN+/LIN-/ (LIN+ - LIN-) + RIGHT (DIFF)/ /RIN+/RIN-/ (RIN+ - RIN-)	MONO + LEFT (DIFF)/ /LIN+/LIN-/ (LIN+ - LIN-) + RIGHT (DIFF)/ /RIN+/RIN-/ (RIN+ - RIN-)

## Power Supplies

The LM4949 uses different supplies for each portion of the device, allowing for the optimum combination of headroom, power dissipation and noise immunity. The speaker amplifier gain stage is powered from VDD, while the output stage is powered from VDDLs. The headphone amplifiers, input amplifiers and volume control stages are powered from VDDHP. The separate power supplies allow the speakers to operate from a higher voltage for maximum headroom, while the headphones operate from a lower voltage, improving power dissipation. VDDHP may be driven by a linear regulator to further improve performance in noisy environments. The I<sup>2</sup>C portion is powered from I<sup>2</sup>CVDD, allowing the I<sup>2</sup>C portion of the LM4949 to interface with lower voltage digital controllers.

## Shutdown Function

The LM4949 features five shutdown modes, configured through the I<sup>2</sup>C interface. Bit D0 (PWR\_ON) in the Shutdown Control register shuts down/turns on the entire device. Set PWR\_ON = 1 to enable the LM4949, set PWR\_ON 0 to disable the device. Bits D0 – D3 in the Output On/Off Control shutdown/turn on the individual channels. HPR\_ON (D3) controls the right channel headphone output, HPL\_ON (D2) controls the left channel headphone output, LSR\_ON (D1) controls the right channel loudspeaker output, and LRL\_ON (D0) controls the left channel loudspeaker output. The PWR\_ON bit takes precedence over the individual channel controls.

## Audio Amplifier Gain Setting

The each channel of the LM4949 has two separate gain stages. Each input stage features a 32 step volume control with a range of -57dB to +18dB (Table 7). Each speaker output stage has 4 gain settings (Table 8); 0dB, 2dB, 4dB, and 6dB when either a fully differential signal or two single ended signals are applied on the \_IN+ and \_IN- pins; and 6dB, 8dB, 10dB and 12dB in single-ended input mode with only one signal applied. The headphone gain is not affected by the input mode. Each headphone output stage has 3 gain settings (Table 9), 0dB, -6dB, and -12dB. This allows for a maximum separation of 24dB between the speaker and headphone outputs when both are active.

Calculate the total gain of a given signal path as follows:

$$A_{VOL} + A_{OS} = A_{TOTAL}$$

where

- $A_{VOL}$  is the volume control level,
- $A_{OS}$  is the gain setting of the output stage, and
- $A_{TOTAL}$  is the total gain for the signal path.

(2)

**Table 7. 32 Step Volume Control**

Volume Step	MG4/LG4/RG4	MG3/LG3/RG3	MG2/LG2/RG2	MG1/LG1/RG1	MG0/LG0/RG0	Gain (dB)
1	0	0	0	0	0	-57
2	0	0	0	0	1	-49
3	0	0	0	1	0	-42
4	0	0	0	1	1	-34.5
5	0	0	1	0	0	-30.5
6	0	0	1	0	1	-27
7	0	0	1	1	0	-24
8	0	0	1	1	1	-21
9	0	1	0	0	0	-18
10	0	1	0	0	1	-15
11	0	1	0	1	0	-13.5
12	0	1	0	1	1	-12
13	0	1	1	0	0	-10.5
14	0	1	1	0	1	-9
15	0	1	1	1	0	-7.5
16	0	1	1	1	1	-6
17	1	0	0	0	0	-4.5
18	1	0	0	0	1	-3
19	1	0	0	1	0	-1.5
20	1	0	0	1	1	0
21	1	0	1	0	0	1.5
22	1	0	1	0	1	3
23	1	0	1	1	0	4.5
24	1	0	1	1	1	6
25	1	1	0	0	0	7.5
26	1	1	0	0	1	9

**Table 7. 32 Step Volume Control (continued)**

Volume Step	MG4/LG4/RG4	MG3/LG3/RG3	MG2/LG2/RG2	MG1/LG1/RG1	MG0/LG0/RG0	Gain (dB)
27	1	1	0	1	0	10.5
28	1	1	0	1	1	12
29	1	1	1	0	0	13.5
30	1	1	1	0	1	15
31	1	1	1	1	0	16.5
32	1	1	1	1	1	18

**Table 8. Loudspeaker Gain Setting**

LSRG1/LSLG1	LSRG0/LSLG0	Gain (dB)	
		_IN+ ≠ _IN-	_IN+ = _IN-
0	0	12	6
0	1	10	4
1	0	8	2
1	1	6	0

**Table 9. Headphone Gain Setting**

HPG1	HPG0	Gain (dB)
0	0	0
0	1	-6
1	0	-12

### Differential Audio Amplifier Configuration

As logic supply voltages continue to shrink, system designers increasingly turn to differential signal handling to preserve signal to noise ratio with decreasing voltage swing. The LM4949 can be configured as a fully differential amplifier, amplifying the difference between the two inputs. The advantage of the differential architecture is any signal component that is common to both inputs is rejected, improving common-mode rejection (CMRR) and increasing the SNR of the amplifier by 6dB over a single-ended architecture. The improved CMRR and SNR of a differential amplifier reduce sensitivity to ground offset related noise injection, especially important in noisy applications such as cellular phones. Driving the LM4949 differentially also allows the inputs to be DC coupled, eliminating two external capacitors per channel. Set bits L1\_INSEL and L2\_INSEL = 0 for differential input mode. The left and right stereo inputs have selectable differential or single-ended input modes, while the mono input is always differential.

### Single-Ended Audio Amplifier Configuration

In single-ended input mode, the audio sources must be capacitively coupled to the LM4949. With LIN+ ≠ LIN- and RIN+ ≠ RIN-, the loud speaker gain is 6dB more than in differential input mode, or when LIN+ = LIN- and RIN+ = RIN-. The headphone gain does not change. The mono input channel is not affected by L1\_INSEL and L2\_INSEL, and is always configured as a differential input.

### Power Dissipation and Efficiency

The major benefit of Class D amplifiers is increased efficiency versus Class AB. The efficiency of the LM4949 speaker amplifiers is attributed to the output transistors' region of operation. The Class D output stage acts as current steering switches, consuming negligible amounts of power compared to their Class AB counterparts. Most of the power loss associated with the output stage is due to the IR loss of the MOSFET on-resistance, along with the switching losses due to gate charge.

The maximum power dissipation per headphone channel in Capacitor-Coupled mode is given by:

$$P_{\text{DMAX}} = V_{\text{DD}}^2 / 2\pi^2 R_L \quad (3)$$

In OCL mode, the maximum power dissipation per headphone channel increases due to the use of a third amplifier as a buffer. The power dissipation is given by:

$$P_{\text{DMAX}} = V_{\text{DD}}^2 / \pi^2 R_L \quad (4)$$

## PROPER SELECTION OF EXTERNAL COMPONENTS

### Audio Amplifier Power Supply Bypassing / Filtering

Proper power supply bypassing is critical for low noise performance and high PSRR. Place the supply bypass capacitors as close to the device as possible. Typical applications employ a voltage regulator with 10 $\mu$ F and 0.1 $\mu$ F bypass capacitors that increase supply stability. These capacitors do not eliminate the need for bypassing of the LM4949 supply pins. A 1 $\mu$ F ceramic capacitor placed close to each supply pin is recommended.

### Bypass Capacitor Selection

The LM4949 generates a  $V_{\text{DD}}/2$  common-mode bias voltage internally. The BYPASS capacitor,  $C_B$ , improves PSRR and THD+N by reducing noise at the BYPASS node. Use a 1 $\mu$ F capacitor, placed as close to the device as possible for  $C_B$ .

### Audio Amplifier Input Capacitor Selection

Input capacitors,  $C_{\text{IN}}$ , in conjunction with the input impedance of the LM4949 forms a high pass filter that removes the DC bias from an incoming signal. The AC-coupling capacitor allows the amplifier to bias the signal to an optimal DC level. Assuming zero source impedance, the -3dB point of the high pass filter is given by:

$$f_{-3\text{dB}} = 1 / 2\pi R_{\text{IN}} C_{\text{IN}} \quad (5)$$

Choose  $C_{\text{IN}}$  such that  $f_{-3\text{dB}}$  is well below the lowest frequency of interest. Setting  $f_{-3\text{dB}}$  too high affects the low-frequency response of the amplifier. Use capacitors with low voltage coefficient dielectrics, such as tantalum or aluminum electrolytic. Capacitors with high-voltage coefficients, such as ceramics, may result in increased distortion at low frequencies. Other factors to consider when designing the input filter include the constraints of the overall system. Although high fidelity audio requires a flat frequency response between 20Hz and 20kHz, portable devices such as cell phones may only concentrate on the frequency range of the spoken human voice (typically 300Hz to 4kHz). In addition, the physical size of the speakers used in such portable devices limits the low frequency response; in this case, frequencies below 150Hz may be filtered out.

## PCB LAYOUT GUIDELINES

Minimize trace impedance of the power, ground and all output traces for optimum performance. Voltage loss due to trace resistance between the LM4949 and the load results in decreased output power and efficiency. Trace resistance between the power supply and GND of the LM4949 has the same effect as a poorly regulated supply, increased ripple and reduced peak output power. Use wide traces for power-supply inputs and amplifier outputs to minimize losses due to trace resistance, as well as route heat away from the device. Proper grounding improves audio performance, minimizes crosstalk between channels and prevents switching noise from interfering with the audio signal. Use of power and ground planes is recommended.

Place all digital components and digital signal traces as far as possible from analog components and traces. Do not run digital and analog traces in parallel on the same PCB layer.

## REVISION HISTORY

Rev	Date	Description
1.0	09/06/06	Initial release.
1.1	09/27/06	Fixed some of the Typical Performance Curves.
1.2	01/17/07	Added the X1, X2, and X3 numerical values of the TLA25JJA mktg outline (back page).
D	05/03/13	Changed layout of National Data Sheet to TI format.

**PACKAGING INFORMATION**

Orderable Device	Status (1)	Package Type	Package Drawing	Pins	Package Qty	Eco Plan (2)	Lead/Ball Finish	MSL Peak Temp (3)	Op Temp (°C)	Top-Side Markings (4)	Samples
LM4949TL/NOPB	ACTIVE	DSBGA	YZR	25	250	Green (RoHS & no Sb/Br)	SNAGCU	Level-1-260C-UNLIM	-40 to 85	GH3	<a href="#">Samples</a>
LM4949TLX/NOPB	ACTIVE	DSBGA	YZR	25	3000	Green (RoHS & no Sb/Br)	SNAGCU	Level-1-260C-UNLIM	-40 to 85	GH3	<a href="#">Samples</a>

(1) The marketing status values are defined as follows:

**ACTIVE:** Product device recommended for new designs.

**LIFEBUY:** TI has announced that the device will be discontinued, and a lifetime-buy period is in effect.

**NRND:** Not recommended for new designs. Device is in production to support existing customers, but TI does not recommend using this part in a new design.

**PREVIEW:** Device has been announced but is not in production. Samples may or may not be available.

**OBSOLETE:** TI has discontinued the production of the device.

(2) Eco Plan - The planned eco-friendly classification: Pb-Free (RoHS), Pb-Free (RoHS Exempt), or Green (RoHS & no Sb/Br) - please check <http://www.ti.com/productcontent> for the latest availability information and additional product content details.

**TBD:** The Pb-Free/Green conversion plan has not been defined.

**Pb-Free (RoHS):** TI's terms "Lead-Free" or "Pb-Free" mean semiconductor products that are compatible with the current RoHS requirements for all 6 substances, including the requirement that lead not exceed 0.1% by weight in homogeneous materials. Where designed to be soldered at high temperatures, TI Pb-Free products are suitable for use in specified lead-free processes.

**Pb-Free (RoHS Exempt):** This component has a RoHS exemption for either 1) lead-based flip-chip solder bumps used between the die and package, or 2) lead-based die adhesive used between the die and leadframe. The component is otherwise considered Pb-Free (RoHS compatible) as defined above.

**Green (RoHS & no Sb/Br):** TI defines "Green" to mean Pb-Free (RoHS compatible), and free of Bromine (Br) and Antimony (Sb) based flame retardants (Br or Sb do not exceed 0.1% by weight in homogeneous material)

(3) MSL, Peak Temp. -- The Moisture Sensitivity Level rating according to the JEDEC industry standard classifications, and peak solder temperature.

(4) Multiple Top-Side Markings will be inside parentheses. Only one Top-Side Marking contained in parentheses and separated by a "~" will appear on a device. If a line is indented then it is a continuation of the previous line and the two combined represent the entire Top-Side Marking for that device.

**Important Information and Disclaimer:** The information provided on this page represents TI's knowledge and belief as of the date that it is provided. TI bases its knowledge and belief on information provided by third parties, and makes no representation or warranty as to the accuracy of such information. Efforts are underway to better integrate information from third parties. TI has taken and continues to take reasonable steps to provide representative and accurate information but may not have conducted destructive testing or chemical analysis on incoming materials and chemicals. TI and TI suppliers consider certain information to be proprietary, and thus CAS numbers and other limited information may not be available for release.

In no event shall TI's liability arising out of such information exceed the total purchase price of the TI part(s) at issue in this document sold by TI to Customer on an annual basis.

## TAPE AND REEL INFORMATION



### QUADRANT ASSIGNMENTS FOR PIN 1 ORIENTATION IN TAPE



\*All dimensions are nominal

Device	Package Type	Package Drawing	Pins	SPQ	Reel Diameter (mm)	Reel Width W1 (mm)	A0 (mm)	B0 (mm)	K0 (mm)	P1 (mm)	W (mm)	Pin1 Quadrant
LM4949TL/NOPB	DSBGA	YZR	25	250	178.0	8.4	2.82	2.82	0.76	4.0	8.0	Q1
LM4949TLX/NOPB	DSBGA	YZR	25	3000	178.0	8.4	2.82	2.82	0.76	4.0	8.0	Q1

## TAPE AND REEL BOX DIMENSIONS



\*All dimensions are nominal

Device	Package Type	Package Drawing	Pins	SPQ	Length (mm)	Width (mm)	Height (mm)
LM4949TL/NOPB	DSBGA	YZR	25	250	210.0	185.0	35.0
LM4949TLX/NOPB	DSBGA	YZR	25	3000	210.0	185.0	35.0

YZR0025

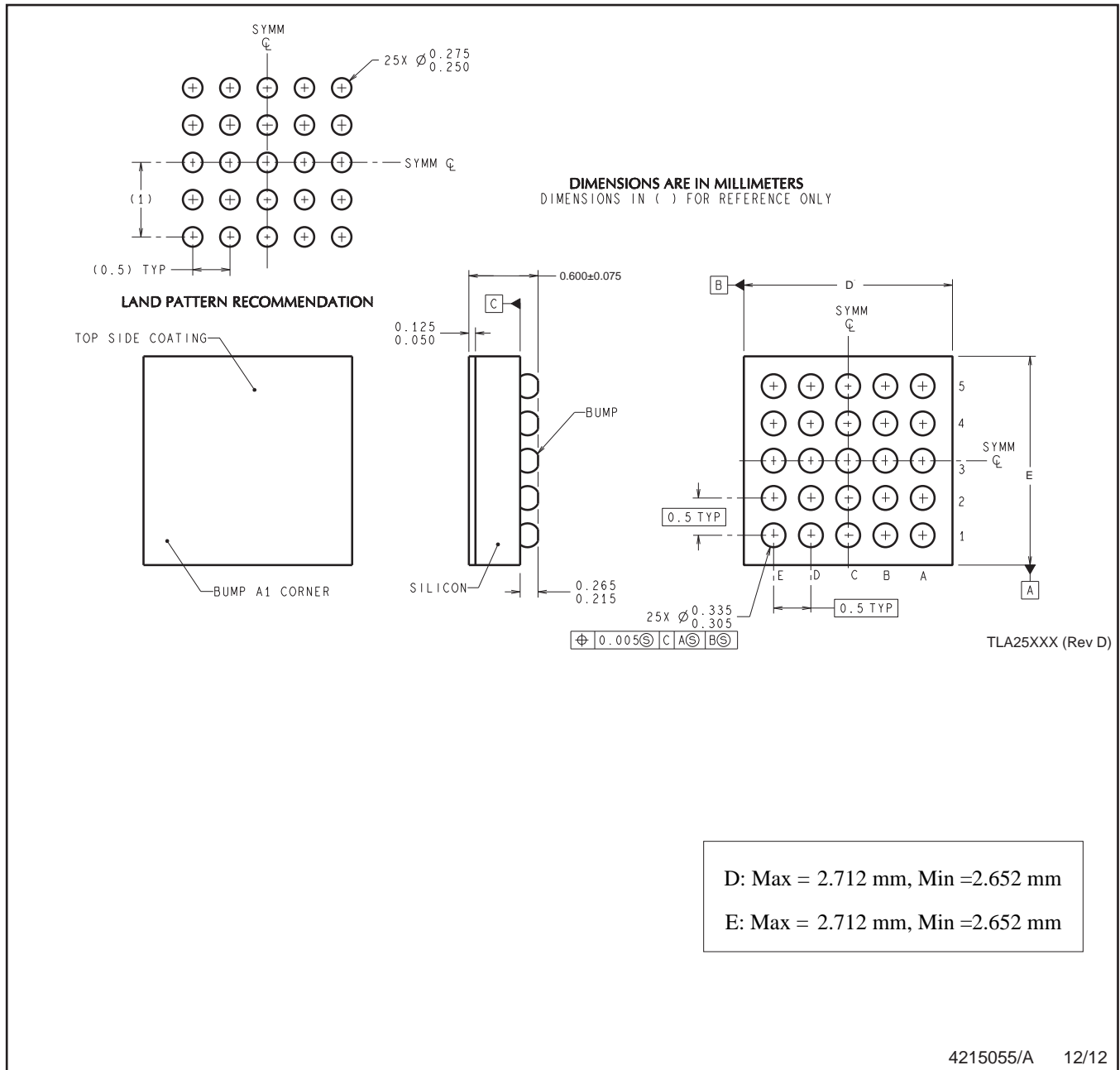

4215055/A 12/12

NOTES: A. All linear dimensions are in millimeters. Dimensioning and tolerancing per ASME Y14.5M-1994.  
B. This drawing is subject to change without notice.



## IMPORTANT NOTICE

Texas Instruments Incorporated and its subsidiaries (TI) reserve the right to make corrections, enhancements, improvements and other changes to its semiconductor products and services per JESD46, latest issue, and to discontinue any product or service per JESD48, latest issue. Buyers should obtain the latest relevant information before placing orders and should verify that such information is current and complete. All semiconductor products (also referred to herein as "components") are sold subject to TI's terms and conditions of sale supplied at the time of order acknowledgment.

TI warrants performance of its components to the specifications applicable at the time of sale, in accordance with the warranty in TI's terms and conditions of sale of semiconductor products. Testing and other quality control techniques are used to the extent TI deems necessary to support this warranty. Except where mandated by applicable law, testing of all parameters of each component is not necessarily performed.

TI assumes no liability for applications assistance or the design of Buyers' products. Buyers are responsible for their products and applications using TI components. To minimize the risks associated with Buyers' products and applications, Buyers should provide adequate design and operating safeguards.

TI does not warrant or represent that any license, either express or implied, is granted under any patent right, copyright, mask work right, or other intellectual property right relating to any combination, machine, or process in which TI components or services are used. Information published by TI regarding third-party products or services does not constitute a license to use such products or services or a warranty or endorsement thereof. Use of such information may require a license from a third party under the patents or other intellectual property of the third party, or a license from TI under the patents or other intellectual property of TI.

Reproduction of significant portions of TI information in TI data books or data sheets is permissible only if reproduction is without alteration and is accompanied by all associated warranties, conditions, limitations, and notices. TI is not responsible or liable for such altered documentation. Information of third parties may be subject to additional restrictions.

Resale of TI components or services with statements different from or beyond the parameters stated by TI for that component or service voids all express and any implied warranties for the associated TI component or service and is an unfair and deceptive business practice. TI is not responsible or liable for any such statements.

Buyer acknowledges and agrees that it is solely responsible for compliance with all legal, regulatory and safety-related requirements concerning its products, and any use of TI components in its applications, notwithstanding any applications-related information or support that may be provided by TI. Buyer represents and agrees that it has all the necessary expertise to create and implement safeguards which anticipate dangerous consequences of failures, monitor failures and their consequences, lessen the likelihood of failures that might cause harm and take appropriate remedial actions. Buyer will fully indemnify TI and its representatives against any damages arising out of the use of any TI components in safety-critical applications.

In some cases, TI components may be promoted specifically to facilitate safety-related applications. With such components, TI's goal is to help enable customers to design and create their own end-product solutions that meet applicable functional safety standards and requirements. Nonetheless, such components are subject to these terms.

No TI components are authorized for use in FDA Class III (or similar life-critical medical equipment) unless authorized officers of the parties have executed a special agreement specifically governing such use.

Only those TI components which TI has specifically designated as military grade or "enhanced plastic" are designed and intended for use in military/aerospace applications or environments. Buyer acknowledges and agrees that any military or aerospace use of TI components which have **not** been so designated is solely at the Buyer's risk, and that Buyer is solely responsible for compliance with all legal and regulatory requirements in connection with such use.

TI has specifically designated certain components as meeting ISO/TS16949 requirements, mainly for automotive use. In any case of use of non-designated products, TI will not be responsible for any failure to meet ISO/TS16949.

### Products

Audio	<a href="http://www.ti.com/audio">www.ti.com/audio</a>
Amplifiers	<a href="http://amplifier.ti.com">amplifier.ti.com</a>
Data Converters	<a href="http://dataconverter.ti.com">dataconverter.ti.com</a>
DLP® Products	<a href="http://www.dlp.com">www.dlp.com</a>
DSP	<a href="http://dsp.ti.com">dsp.ti.com</a>
Clocks and Timers	<a href="http://www.ti.com/clocks">www.ti.com/clocks</a>
Interface	<a href="http://interface.ti.com">interface.ti.com</a>
Logic	<a href="http://logic.ti.com">logic.ti.com</a>
Power Mgmt	<a href="http://power.ti.com">power.ti.com</a>
Microcontrollers	<a href="http://microcontroller.ti.com">microcontroller.ti.com</a>
RFID	<a href="http://www.ti-rfid.com">www.ti-rfid.com</a>
OMAP Applications Processors	<a href="http://www.ti.com/omap">www.ti.com/omap</a>
Wireless Connectivity	<a href="http://www.ti.com/wirelessconnectivity">www.ti.com/wirelessconnectivity</a>

### Applications

Automotive and Transportation	<a href="http://www.ti.com/automotive">www.ti.com/automotive</a>
Communications and Telecom	<a href="http://www.ti.com/communications">www.ti.com/communications</a>
Computers and Peripherals	<a href="http://www.ti.com/computers">www.ti.com/computers</a>
Consumer Electronics	<a href="http://www.ti.com/consumer-apps">www.ti.com/consumer-apps</a>
Energy and Lighting	<a href="http://www.ti.com/energy">www.ti.com/energy</a>
Industrial	<a href="http://www.ti.com/industrial">www.ti.com/industrial</a>
Medical	<a href="http://www.ti.com/medical">www.ti.com/medical</a>
Security	<a href="http://www.ti.com/security">www.ti.com/security</a>
Space, Avionics and Defense	<a href="http://www.ti.com/space-avionics-defense">www.ti.com/space-avionics-defense</a>
Video and Imaging	<a href="http://www.ti.com/video">www.ti.com/video</a>

### TI E2E Community

[e2e.ti.com](http://e2e.ti.com)