

## ISL83204A

60V/2.5A Peak, High Frequency Full Bridge FET Driver

FN6397  
Rev.2.00  
March 20, 2007

The ISL83204A is a high frequency, medium voltage Full Bridge N-Channel FET driver IC, available in 20 lead plastic SOIC and DIP packages. The ISL83204A includes an input comparator used to facilitate the “hysteresis” and PWM modes of operation. Its HEN (high enable) lead can force current to freewheel in the bottom two external power MOSFETs, maintaining the upper power MOSFETs off. Since it can switch at frequencies up to 1MHz, the ISL83204A is well suited for driving Voice Coil Motors, switching power amplifiers and power supplies.

ISL83204A can also drive medium voltage brush motors, and two ISL83204As can be used to drive high performance stepper motors, since the short minimum “on-time” can provide fine micro-stepping capability.

Short propagation delays of approximately 55ns maximize control loop crossover frequencies and dead-times which can be adjusted to near zero to minimize distortion, resulting in precise control of the driven load.

### Ordering Information

PART NUMBER	PART MARKING	TEMP RANGE (°C)	PACKAGE	PKG. DWG. #
ISL83204AIPZ (Note)	ISL83204AIPZ	-40 to +85	20 Ld PDIP (Pb-Free)	E20.3
ISL83204AIBZ* (Note)	ISL83204AIBZ	-40 to +85	20 Ld SOIC (Pb-Free)	M20.3

\*Add “-T” suffix for tape and reel.

NOTE: Intersil Pb-free plus anneal products employ special Pb-free material sets; molding compounds/die attach materials and 100% matte tin plate termination finish, which are RoHS compliant and compatible with both SnPb and Pb-free soldering operations. Intersil Pb-free products are MSL classified at Pb-free peak reflow temperatures that meet or exceed the Pb-free requirements of IPC/JEDEC J STD-020.

### Features

- Drives N-Channel FET Full Bridge Including High Side Chop Capability
- Bootstrap Supply Max Voltage to 75VDC
- Drives 1000pF Load at 1MHz in Free Air at +50°C with Rise and Fall Times of Typically 10ns
- User-Programmable Dead Time
- Charge-Pump and Bootstrap Maintain Upper Bias Supplies
- DIS (Disable) Pin Pulls Gates Low
- Input Logic Thresholds Compatible with 5V to 15V Logic Levels
- Very Low Power Consumption
- Undervoltage Protection
- Pb-Free Plus Anneal Available (RoHS Compliant)

### Applications

- Medium/Large Voice Coil Motors
- Full Bridge Power Supplies
- Switching Power Amplifiers
- Uninterruptible Power Supplies
- High Performance Motor Controls
- Noise Cancellation Systems
- Battery Powered Vehicles

### Pinout

ISL83204A  
(20 LD PDIP, 20 LD SOIC)  
TOP VIEW

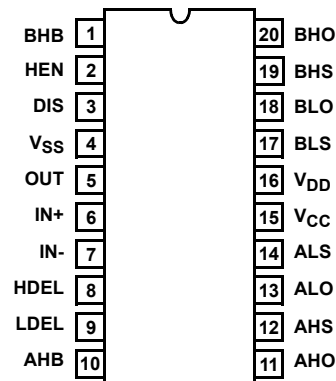

**Application Block Diagram**

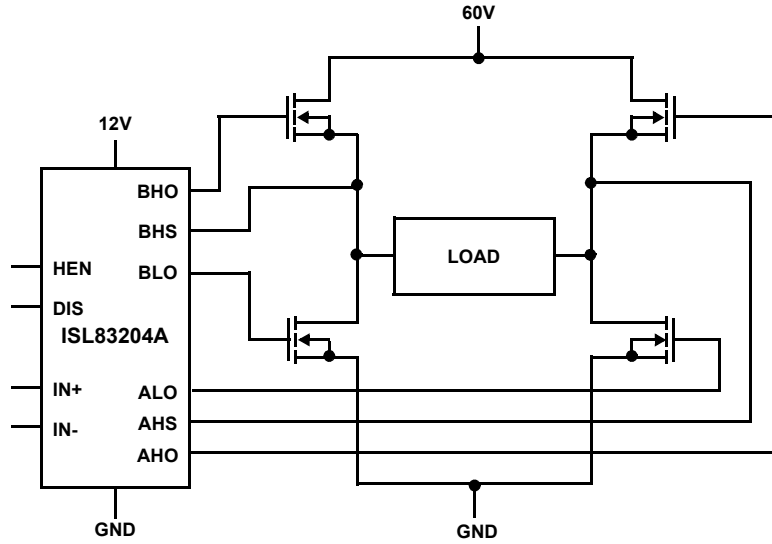

**Functional Block Diagram (1/2 ISL83204A)**

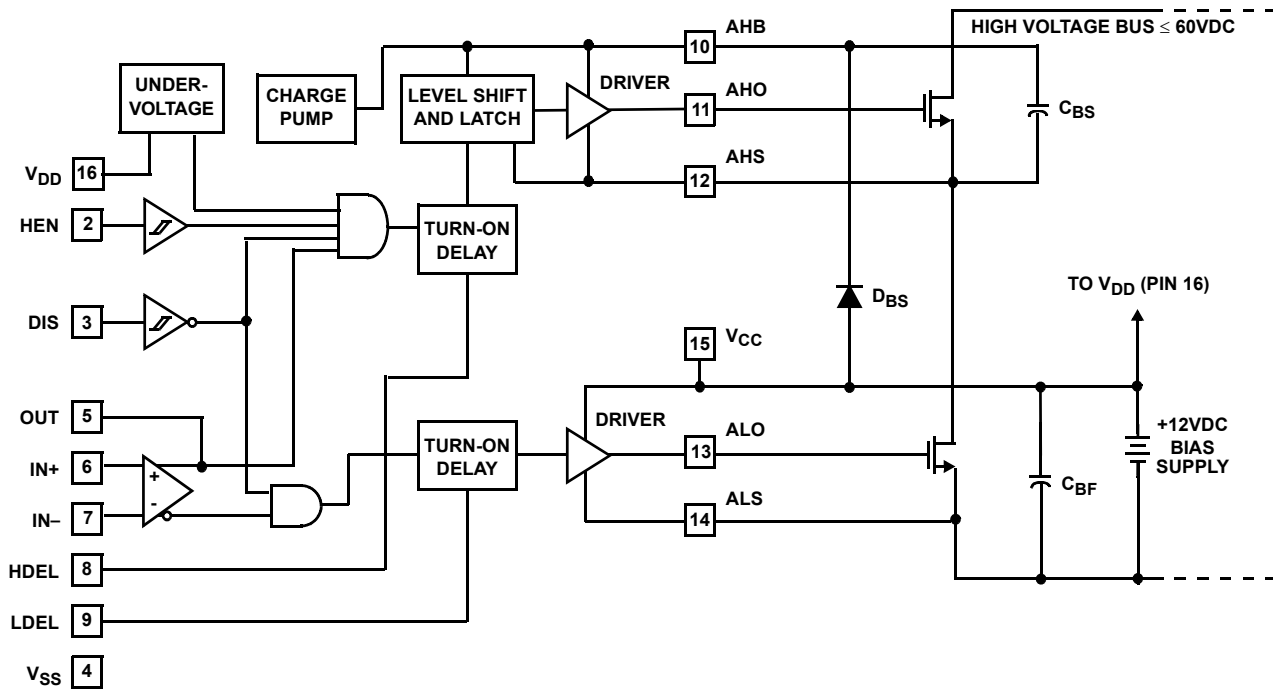



**Absolute Maximum Ratings**

Supply Voltage,  $V_{DD}$  and  $V_{CC}$  ..... -0.3V to 16V  
 Logic I/O Voltages ..... -0.3V to  $V_{DD} + 0.3V$   
 Voltage on AHS, BHS . . -6.0V (Transient) to 70V (+25°C to +125°C)  
 Voltage on AHS, BHS . . -6.0V (Transient) to 70V (-55°C to +125°C)  
 Voltage on ALS, BLS ..... -2.0V (Transient) to +2.0V (Transient)  
 Voltage on AHB, BHB .....  $V_{AHS}$ , BHS -0.3V to  $V_{AHS}$ , BHS + $V_{DD}$   
 Voltage on ALO, BLO .....  $V_{ALS}$ , BLS -0.3V to  $V_{CC} + 0.3V$   
 Voltage on AHO, BHO .....  $V_{AHS}$ , BHS -0.3V to  $V_{AHB}$ , BHB +0.3V  
 Input Current, HDEL and LDEL ..... -5mA to 0mA  
 Phase Slew Rate ..... 20V/ns  
 All Voltages relative to  $V_{SS}$ , unless otherwise specified.

**Operating Conditions**

Supply Voltage,  $V_{DD}$  and  $V_{CC}$  ..... +9.5V to +15V  
 Voltage on ALS, BLS ..... -1.0V to +1.0V  
 Voltage on AHB, BHB .....  $V_{AHS}$ , BHS +5V to  $V_{AHS}$ , BHS +15V  
 Voltage on AHS, BHS ..... 60V  
 Input Current, HDEL and LDEL ..... -500 $\mu$ A to -50 $\mu$ A  
 Operating Ambient Temperature Range ..... -40°C to +85°C

**CAUTION:** Stresses above those listed in "Absolute Maximum Ratings" may cause permanent damage to the device. This is a stress only rating and operation of the device at these or any other conditions above those indicated in the operational sections of this specification is not implied.

**NOTE:**

- $\theta_{JA}$  is measured with the component mounted on a low effective thermal conductivity test board in free air. See Tech Brief TB379 for details.

**Electrical Specifications**  $V_{DD} = V_{CC} = V_{AHB} = V_{BHB} = 12V$ ,  $V_{SS} = V_{ALS} = V_{BLS} = V_{AHS} = V_{BHS} = 0V$ ,  $R_{HDEL} = R_{LDEL} = 100k$ , and  $T_A = +25^\circ C$ , Unless Otherwise Specified

PARAMETERS	SYMBOL	TEST CONDITIONS	$T_J = +25^\circ C$			$T_J = -40^\circ C$ to $+125^\circ C$		UNITS
			MIN	TYP	MAX	MIN	MAX	
<b>SUPPLY CURRENTS AND CHARGE PUMPS</b>								
$V_{DD}$ Quiescent Current	$I_{DD}$	IN- = 2.5V, Other Inputs = 0V	8	11	14	7	14	mA
$V_{DD}$ Operating Current	$I_{DDO}$	Outputs switching f = 500kHz, No Load	8	12	15	8	15	mA
$V_{CC}$ Quiescent Current	$I_{CC}$	IN- = 2.5V, Other Inputs = 0V, $I_{ALO} = I_{BLO} = 0$	-	25	80	-	100	$\mu$ A
$V_{CC}$ Operating Current	$I_{CCO}$	f = 500kHz, No Load	1	1.25	2.0	0.8	3	mA
AHB, BHB Quiescent Current -Qpump Output Current	$I_{AHB}$ , $I_{BHB}$	IN- = 2.5V, Other Inputs = 0V, $I_{AHO} = I_{BHO} = 0$ , $V_{DD} = V_{CC} = V_{AHB} = V_{BHB} = 10V$	-50	-25	-11	-60	-10	$\mu$ A
AHB, BHB Operating Current	$I_{AHBO}$ , $I_{BHBO}$	f = 500kHz, No Load	0.62	1.2	1.5	0.5	1.9	mA
AHS, BHS, AHB, BHB Leakage Current	$I_{HLK}$	$V_{BHS} = V_{AHS} = 60V$ , $V_{AHB} = V_{BHB} = 75V$	-	0.02	1.0	-	10	$\mu$ A
AHB-AHS, BHB-BHS Qpump Output Voltage	$V_{AHB} - V_{AHS}$ $V_{BHB} - V_{BHS}$	$I_{AHB} = I_{AHS} = 0$ , No Load	11.5	12.6	14.0	10.5	14.5	V
<b>INPUT COMPARATOR PINS: IN+, IN-, OUT</b>								
Offset Voltage	$V_{OS}$	Over Common Mode Voltage Range	-10	0	+10	-15	+15	mV
Input Bias Current	$I_{IB}$		0	0.5	2	0	4	$\mu$ A
Input Offset Current	$I_{OS}$		-1	0	+1	-2	+2	$\mu$ A
Input Common Mode Voltage Range	CMVR		1	-	$V_{DD} - 1.5$	1	$V_{DD} - 1.5$	V

**Thermal Information**

Thermal Resistance (Typical, Note 1)  $\theta_{JA}$  ( $^\circ C/W$ )  
 SOIC Package ..... 85  
 PDIP Package ..... 75  
 Maximum Power Dissipation at +85°C  
 SOIC Package ..... 470mW  
 PDIP Package ..... 530mW  
 Storage Temperature Range ..... -65°C to +150°C  
 Operating Max. Junction Temperature ..... +125°C  
 Lead Temperature (Soldering 10s) ..... +300°C  
 (For SOIC - Lead Tips Only)

**Electrical Specifications**  $V_{DD} = V_{CC} = V_{AHB} = V_{BHB} = 12V$ ,  $V_{SS} = V_{ALS} = V_{BLS} = V_{AHS} = V_{BHS} = 0V$ ,  $R_{HDEL} = R_{LDEL} = 100k$ , and  $T_A = +25^{\circ}C$ , Unless Otherwise Specified **(Continued)**

PARAMETERS	SYMBOL	TEST CONDITIONS	$T_J = +25^{\circ}C$			$T_J = -40^{\circ}C \text{ to } +125^{\circ}C$		UNITS
			MIN	TYP	MAX	MIN	MAX	
Voltage Gain	AVOL		-	25	-	-	-	V/mV
OUT High Level Output Voltage	$V_{OH}$	$IN+ > IN-$ , $I_{OH} = -250\mu A$	$V_{DD} - 0.4$	-	-	$V_{DD} - 0.5$	-	V
OUT Low Level Output Voltage	$V_{OL}$	$IN+ < IN-$ , $I_{OL} = +250\mu A$	-	-	0.4	-	0.5	V
Low Level Output Current	$I_{OL}$	$V_{OUT} = 6V$	6.5	14	19	6	20	mA
High Level Output Current	$I_{OH}$	$V_{OUT} = 6V$	-17	-10	-3	-20	-2.5	mA
<b>INPUT PINS: DIS</b>								
Low Level Input Voltage	$V_{IL}$	Full Operating Conditions	-	-	1.0	-	0.8	V
High Level Input Voltage	$V_{IH}$	Full Operating Conditions	2.5	-	-	2.7	-	V
Input Voltage Hysteresis			-	35	-	-	-	mV
Low Level Input Current	$I_{IL}$	$V_{IN} = 0V$ , Full Operating Conditions	-130	-100	-75	-135	-65	$\mu A$
High Level Input Current	$I_{IH}$	$V_{IN} = 5V$ , Full Operating Conditions	-1	-	+1	-10	+10	$\mu A$
<b>INPUT PINS: HEN</b>								
Low Level Input Voltage	$V_{IL}$	Full Operating Conditions	-	-	1.0	-	0.8	V
High Level Input Voltage	$V_{IH}$	Full Operating Conditions	2.5	-	-	2.7	-	V
Input Voltage Hysteresis			-	35	-	-	-	mV
Low Level Input Current	$I_{IL}$	$V_{IN} = 0V$ , Full Operating Conditions	-260	-200	-150	-270	-130	$\mu A$
High Level Input Current	$I_{IH}$	$V_{IN} = 5V$ , Full Operating Conditions	-1	-	+1	-10	+10	$\mu A$
<b>TURN-ON DELAY PINS: LDEL AND HDEL</b>								
LDEL, HDEL Voltage	$V_{HDEL}, V$	$I_{HDEL} = I_{LDEL} = -100\mu A$	4.9	5.1	5.3	4.8	5.4	V
<b>GATE DRIVER OUTPUT PINS: ALO, BLO, AHO, AND BHO</b>								
Low Level Output Voltage	$V_{OL}$	$I_{OUT} = 100mA$	0.7	0.85	1.0	0.5	1.1	V
High Level Output Voltage	$V_{CC} - V_{OH}$	$I_{OUT} = -100mA$	0.8	0.95	1.1	0.5	1.2	V
Peak Pullup Current	$I_{O+}$	$V_{OUT} = 0V$	1.7	2.6	3.8	1.4	4.1	A
Peak Pulldown Current	$I_{O-}$	$V_{OUT} = 12V$	1.7	2.4	3.3	1.3	3.6	A
Under Voltage, Rising Threshold	UV+		8.1	8.8	9.4	8.0	9.5	V
Under Voltage, Falling Threshold	UV-		7.6	8.3	8.9	7.5	9.0	V
Under Voltage, Hysteresis	HYS		0.25	0.4	0.65	0.2	0.7	V

**Switching Specifications**  $V_{DD} = V_{CC} = V_{AHB} = V_{BHB} = 12V$ ,  $V_{SS} = V_{ALS} = V_{BLS} = V_{AHS} = V_{BHS} = 0V$ ,  $R_{HDEL} = R_{LDEL} = 10k$ ,  $C_L = 1000pF$ , and  $T_A = +25^\circ C$ , Unless Otherwise Specified

PARAMETERS	SYMBOL	TEST CONDITIONS	$T_J = +25^\circ C$			$T_J = -40^\circ C \text{ to } +125^\circ C$		UNITS
			MIN	TYP	MAX	MIN	MAX	
Lower Turn-off Propagation Delay (IN+/IN- to ALO/BLO)	$t_{LPHL}$		-	40	70	-	90	ns
Upper Turn-off Propagation Delay (IN+/IN- to AHO/BHO)	$t_{HPHL}$		-	50	80	-	110	ns
Lower Turn-on Propagation Delay (IN+/IN- to ALO/BLO)	$t_{LPLH}$		-	40	70	-	90	ns
Upper Turn-on Propagation Delay (IN+/IN- to AHO/BHO)	$t_{HPLH}$		-	70	110	-	140	ns
Rise Time	$t_R$		-	10	25	-	35	ns
Fall Time	$t_F$		-	10	25	-	35	ns
Turn-on Input Pulse Width	$t_{PWIN-ON}$		50	-	-	50	-	ns
Turn-off Input Pulse Width	$t_{PWIN-OFF}$		40	-	-	40	-	ns
Disable Turn-off Propagation Delay (DIS - Lower Outputs)	$t_{DISLOW}$		-	45	75	-	95	ns
Disable Turn-off Propagation Delay (DIS - Upper Outputs)	$t_{DISHIGH}$		-	55	85	-	105	ns
Disable to Lower Turn-on Propagation Delay (DIS - ALO and BLO)	$t_{DLPLH}$		-	45	70	-	90	ns
Refresh Pulse Width (ALO and BLO)	$t_{REF-PW}$		240	380	500	200	600	ns
Disable to Upper Enable (DIS - AHO and BHO)	$t_{UEN}$		-	480	630	-	750	ns
HEN-AHO, BHO Turn-off, Propagation Delay	$t_{HEN-PHL}$	$R_{HDEL} = R_{LDEL} = 10k$	-	40	70	-	90	ns
HEN-AHO, BHO Turn-on, Propagation Delay	$t_{HEN-PLH}$	$R_{HDEL} = R_{LDEL} = 10k$	-	60	90	-	110	ns

TRUTH TABLE

INPUT				OUTPUT			
IN+ > IN-	HEN	U/V	DIS	ALO	AHO	BLO	BHO
X	X	X	1	0	0	0	0
0	0	0	0	1	0	0	0
1	1	0	0	0	1	1	0
0	1	0	0	1	0	0	1
1	0	0	0	0	0	1	0
X	X	1	X	0	0	0	0

## Pin Descriptions

PIN NUMBER	SYMBOL	DESCRIPTION
1	BHB	B High-side Bootstrap supply. External bootstrap diode and capacitor are required. Connect cathode of bootstrap diode and positive side of bootstrap capacitor to this pin. Internal charge pump supplies 30 $\mu$ A out of this pin to maintain bootstrap supply. Internal circuitry clamps the bootstrap supply to approximately 12.8V.
2	HEN	High-side Enable input. Logic level input that when low overrides IN+/IN- (Pins 6 and 7) to put AHO and BHO drivers (Pins 11 and 20) in low output state. When HEN is high AHO and BHO are controlled by IN+/IN- inputs. The pin can be driven by signal levels of 0V to 15V (no greater than $V_{DD}$ ).
3	DIS	DISable input. Logic level input that when taken high sets all four outputs low. DIS high overrides all other inputs. When DIS is taken low the outputs are controlled by the other inputs. The pin can be driven by signal levels of 0V to 15V (no greater than $V_{DD}$ ).
4	$V_{SS}$	Chip negative supply, generally will be ground.
5	OUT	OUTput of the input control comparator. This output can be used for feedback and hysteresis.
6	IN+	Noninverting input of control comparator. If IN+ is greater than IN- (Pin 7) then ALO and BHO are low level outputs and BLO and AHO are high level outputs. If IN+ is less than IN- then ALO and BHO are high level outputs and BLO and AHO are low level outputs. DIS (Pin 3) high level will override IN+/IN- control for all outputs. HEN (Pin 2) low level will override IN+/IN- control of AHO and BHO. When switching in four quadrant mode, dead time in a half bridge leg is controlled by HDEL and LDEL (Pins 8 and 9).
7	IN-	Inverting input of control comparator. See IN+ (Pin 6) description.
8	HDEL	High-side turn-on DELay. Connect resistor from this pin to $V_{SS}$ to set timing current that defines the turn-on delay of both high-side drivers. The low-side drivers turn-off with no adjustable delay, so the HDEL resistor guarantees no shoot-through by delaying the turn-on of the high-side drivers. HDEL reference voltage is approximately 5.1V.
9	LDEL	Low-side turn-on DELay. Connect resistor from this pin to $V_{SS}$ to set timing current that defines the turn-on delay of both low-side drivers. The high-side drivers turn-off with no adjustable delay, so the LDEL resistor guarantees no shoot-through by delaying the turn-on of the low-side drivers. LDEL reference voltage is approximately 5.1V.
10	AHB	A High-side Bootstrap supply. External bootstrap diode and capacitor are required. Connect cathode of bootstrap diode and positive side of bootstrap capacitor to this pin. Internal charge pump supplies 30 $\mu$ A out of this pin to maintain bootstrap supply. Internal circuitry clamps the bootstrap supply to approximately 12.8V.
11	AHO	A High-side Output. Connect to gate of A High-side power MOSFET.
12	AHS	A High-side Source connection. Connect to source of A High-side power MOSFET. Connect negative side of bootstrap capacitor to this pin.
13	ALO	A Low-side Output. Connect to gate of A Low-side power MOSFET.
14	ALS	A Low-side Source connection. Connect to source of A Low-side power MOSFET.
15	$V_{CC}$	Positive supply to gate drivers. Must be same potential as $V_{DD}$ (Pin 16). Connect to anodes of two bootstrap diodes.
16	$V_{DD}$	Positive supply to lower gate drivers. Must be same potential as $V_{CC}$ (Pin 15). De-couple this pin to $V_{SS}$ (Pin 4).
17	BLS	B Low-side Source connection. Connect to source of B Low-side power MOSFET.
18	BLO	B Low-side Output. Connect to gate of B Low-side power MOSFET.
19	BHS	B High-side Source connection. Connect to source of B High-side power MOSFET. Connect negative side of bootstrap capacitor to this pin.
20	BHO	B High-side Output. Connect to gate of B High-side power MOSFET.

**Timing Diagrams**

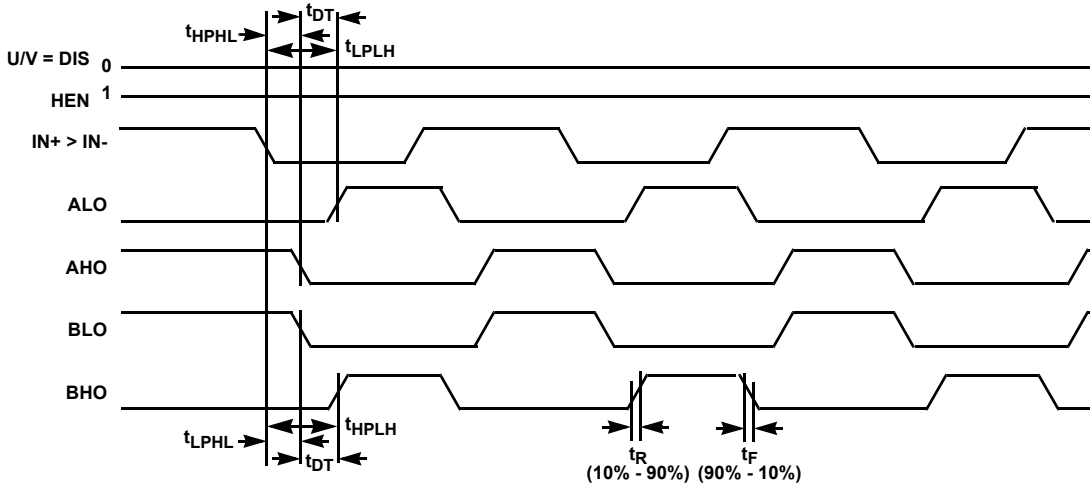

**FIGURE 1. BI-STATE MODE**

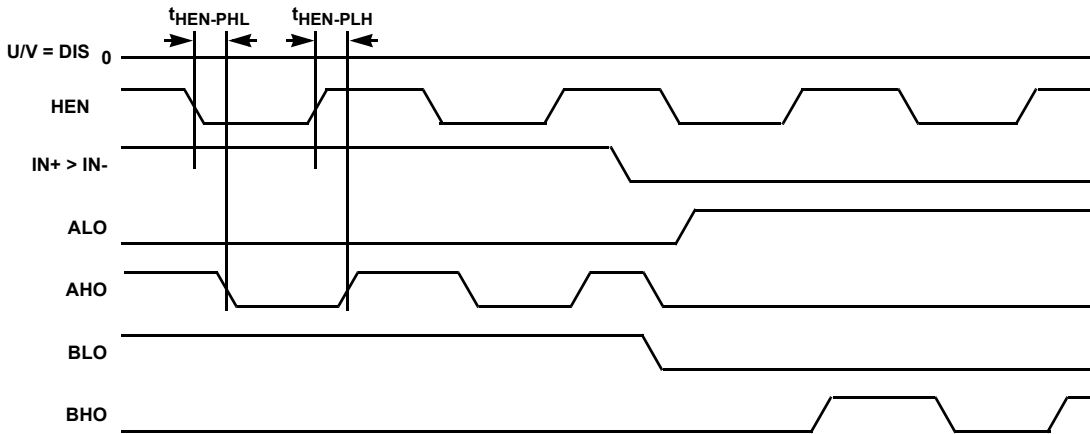

**FIGURE 2. HIGH SIDE CHOP MODE**

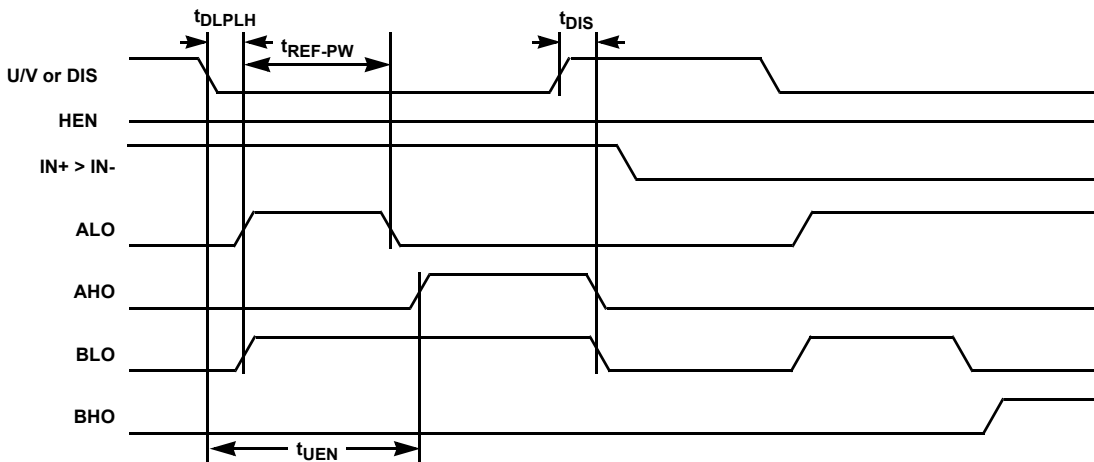

**FIGURE 3. DISABLE FUNCTION**



**Typical Performance Curves**  $V_{DD} = V_{CC} = V_{AHB} = V_{BHB} = 12V$ ,  $V_{SS} = V_{ALS} = V_{BLS} = V_{AHS} = V_{BHS} = 0V$ ,  $R_{HDEL} = R_{LDEL} = 100k$ , and  $T_A = +25^\circ C$ , Unless Otherwise Specified.

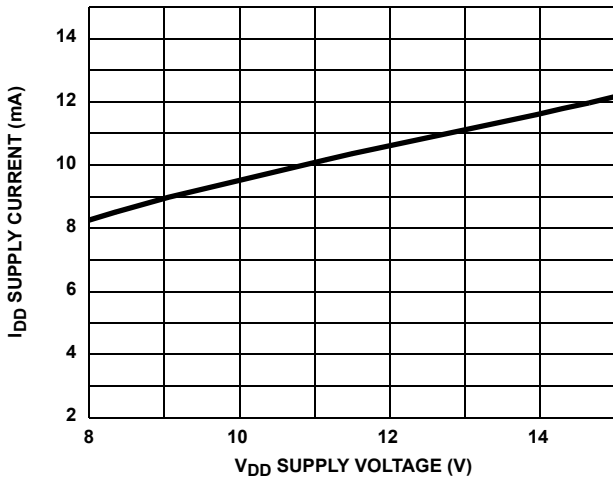

FIGURE 4. QUIESCENT I<sub>DD</sub> SUPPLY CURRENT vs V<sub>DD</sub> SUPPLY VOLTAGE

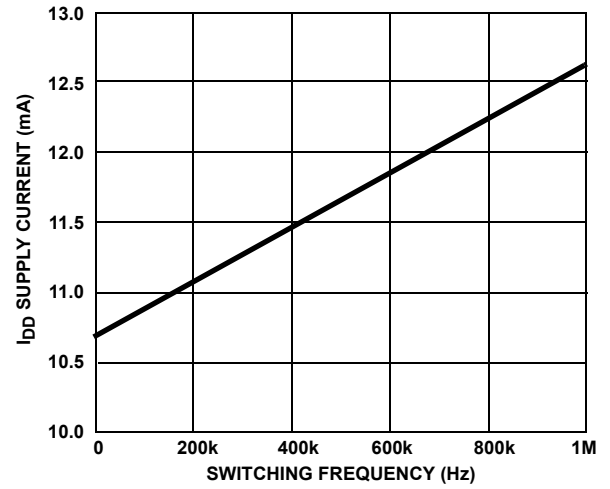

FIGURE 5. I<sub>DD0</sub> NO-LOAD I<sub>DD</sub> SUPPLY CURRENT vs FREQUENCY (Hz)

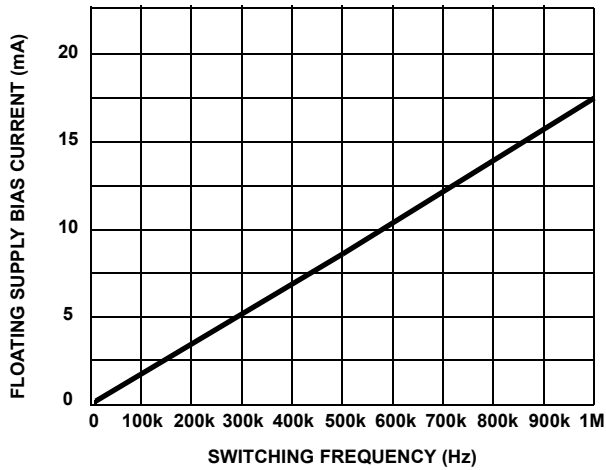

FIGURE 6. SIDE A, B FLOATING SUPPLY BIAS CURRENT vs FREQUENCY (LOAD = 1000pF)

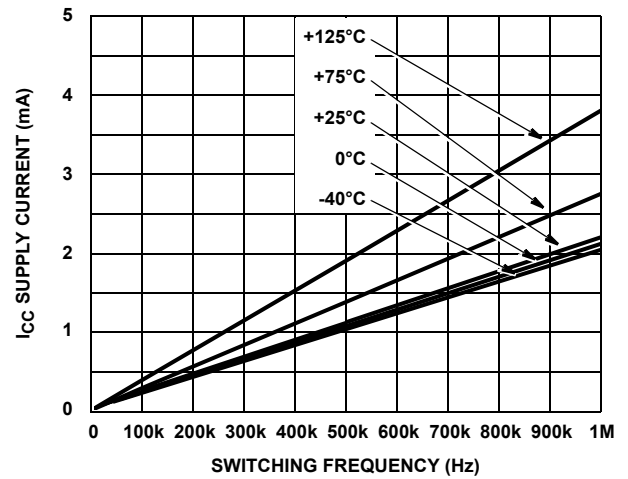

FIGURE 7. I<sub>CC0</sub>, NO-LOAD I<sub>CC</sub> SUPPLY CURRENT vs FREQUENCY (Hz) TEMPERATURE

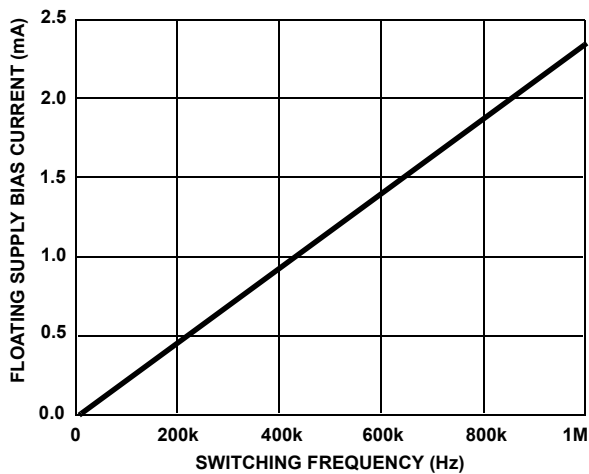

FIGURE 8. I<sub>AHB</sub>, I<sub>BHB</sub> NO-LOAD FLOATING SUPPLY BIAS CURRENT vs FREQUENCY

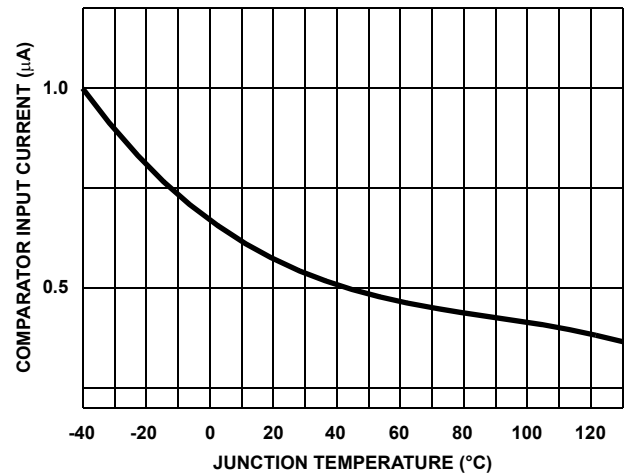

FIGURE 9. COMPARATOR INPUT CURRENT I<sub>L</sub> vs TEMPERATURE AT V<sub>CM</sub> = 5V

**Typical Performance Curves**  $V_{DD} = V_{CC} = V_{AHB} = V_{BHB} = 12V$ ,  $V_{SS} = V_{ALS} = V_{BLS} = V_{AHS} = V_{BHS} = 0V$ ,  
 $R_{HDEL} = R_{LDEL} = 100k$ , and  $T_A = +25^\circ C$ , Unless Otherwise Specified. (Continued)

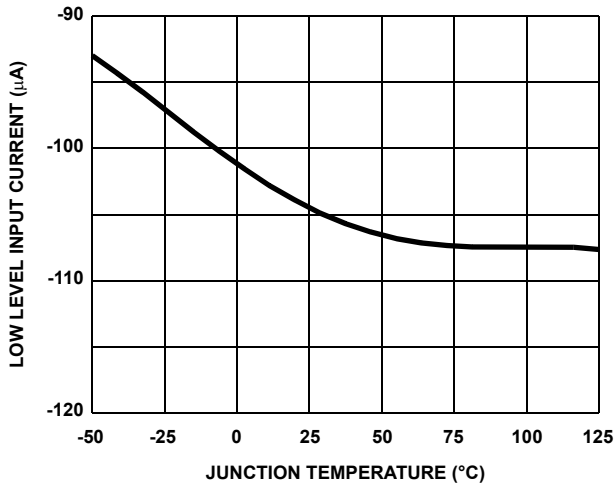

FIGURE 10. DIS LOW LEVEL INPUT CURRENT  $I_{IL}$  vs TEMPERATURE

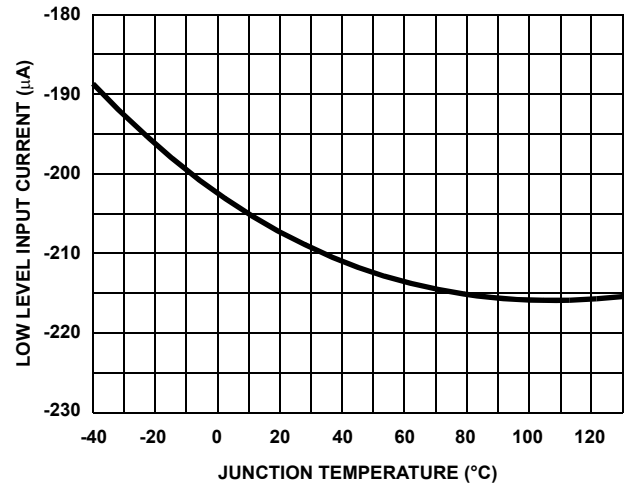

FIGURE 11. HEN LOW LEVEL INPUT CURRENT  $I_{IL}$  vs TEMPERATURE

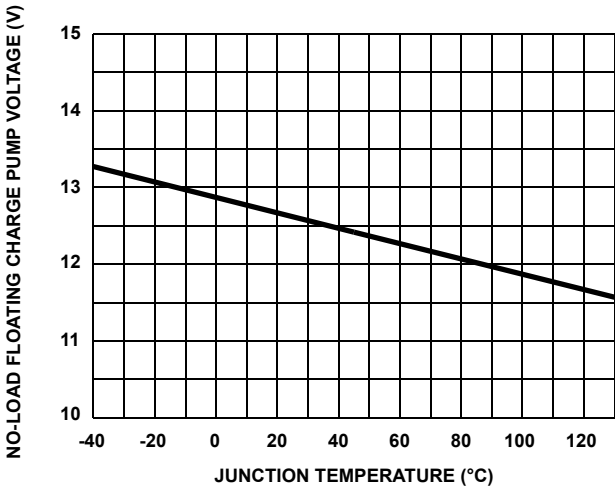

FIGURE 12. AHB - AHS, BHB - BHS NO-LOAD CHARGE PUMP VOLTAGE vs TEMPERATURE

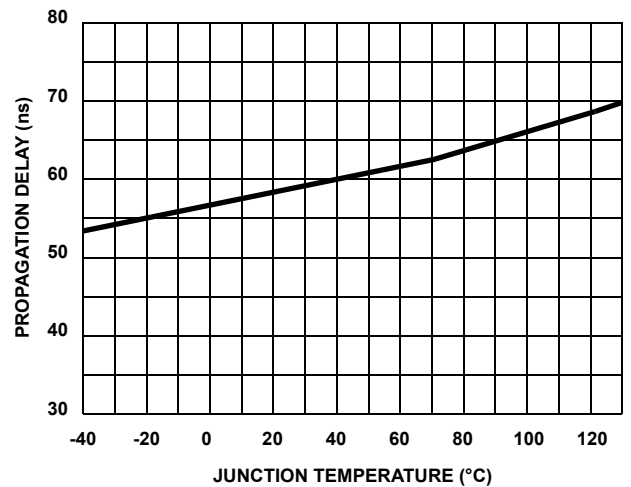

FIGURE 13. UPPER DISABLE TURN-OFF PROPAGATION DELAY  $t_{DISHIGH}$  vs TEMPERATURE

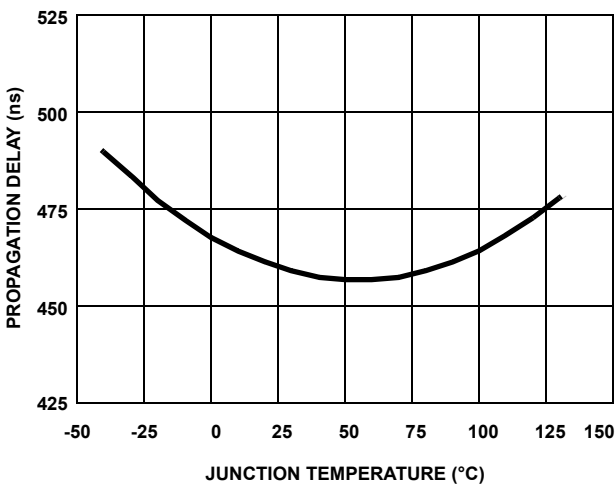

FIGURE 14. DISABLE TO UPPER ENABLE  $t_{UEN}$  PROPAGATION DELAY vs TEMPERATURE

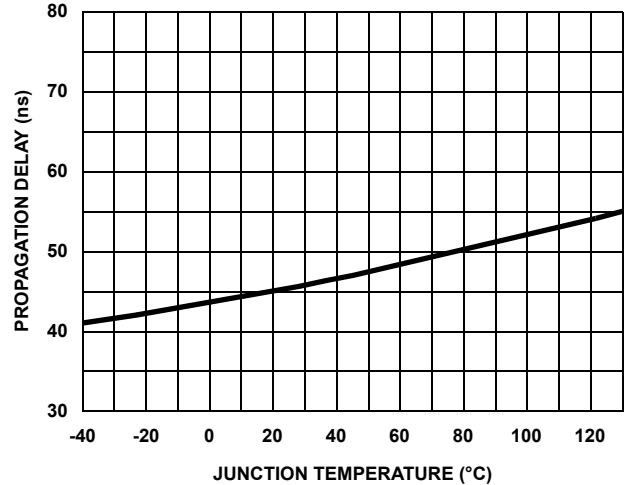

FIGURE 15. LOWER DISABLE TURN-OFF PROPAGATION DELAY  $t_{DISLOW}$  vs TEMPERATURE

**Typical Performance Curves**  $V_{DD} = V_{CC} = V_{AHB} = V_{BHB} = 12V$ ,  $V_{SS} = V_{ALS} = V_{BLS} = V_{AHS} = V_{BHS} = 0V$ ,  
 $R_{HDEL} = R_{LDEL} = 100k$ , and  $T_A = +25^\circ C$ , Unless Otherwise Specified. (Continued)

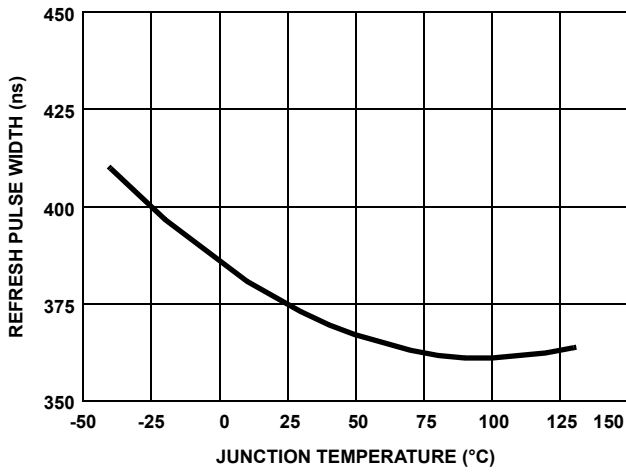

FIGURE 16.  $t_{REF-PW}$  REFRESH PULSE WIDTH vs TEMPERATURE

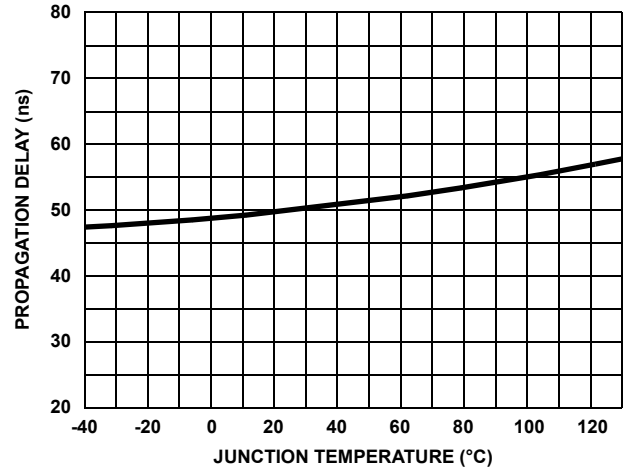

FIGURE 17. DISABLE TO LOWER ENABLE  $t_{DLPLH}$  PROPAGATION DELAY vs TEMPERATURE

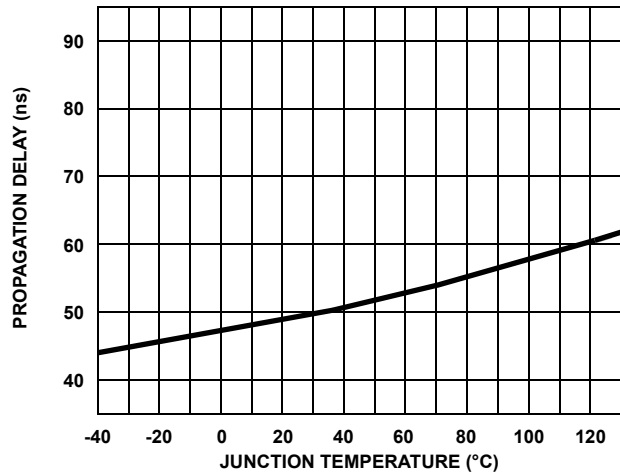

FIGURE 18. UPPER TURN-OFF PROPAGATION DELAY  $t_{HPLH}$  vs TEMPERATURE

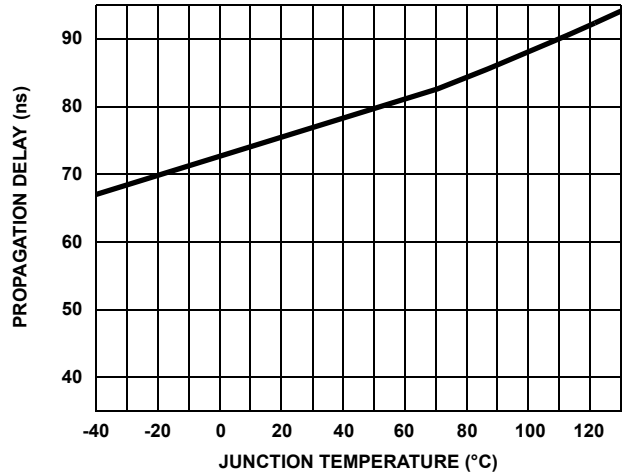

FIGURE 19. UPPER TURN-ON PROPAGATION DELAY  $t_{HPLH}$  vs TEMPERATURE

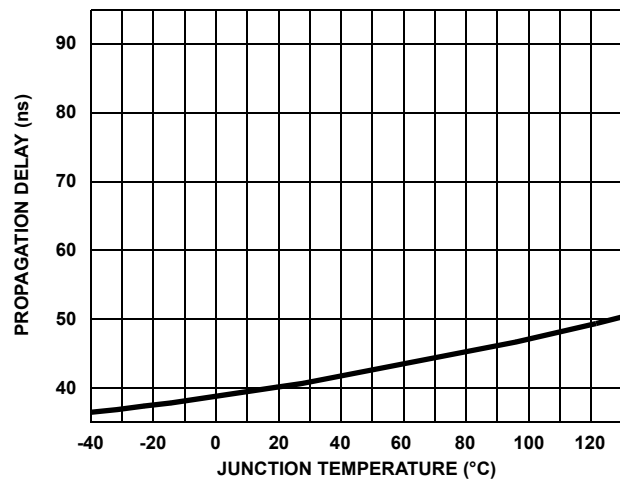

FIGURE 20. LOWER TURN-OFF PROPAGATION DELAY  $t_{LPHL}$  vs TEMPERATURE

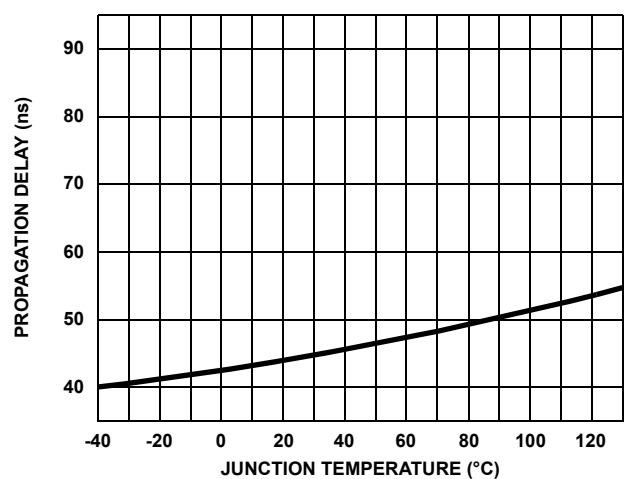

FIGURE 21. LOWER TURN-ON PROPAGATION DELAY  $t_{LPLH}$  vs TEMPERATURE

**Typical Performance Curves**  $V_{DD} = V_{CC} = V_{AHB} = V_{BHB} = 12V$ ,  $V_{SS} = V_{ALS} = V_{BLS} = V_{AHS} = V_{BHS} = 0V$ ,  $R_{HDEL} = R_{LDEL} = 100K$ , and  $T_A = +25^\circ C$ , Unless Otherwise Specified.

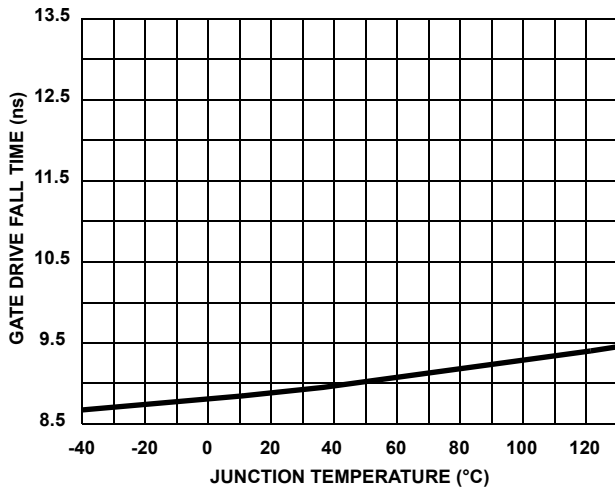

FIGURE 22. GATE DRIVE FALL TIME  $t_f$  vs TEMPERATURE

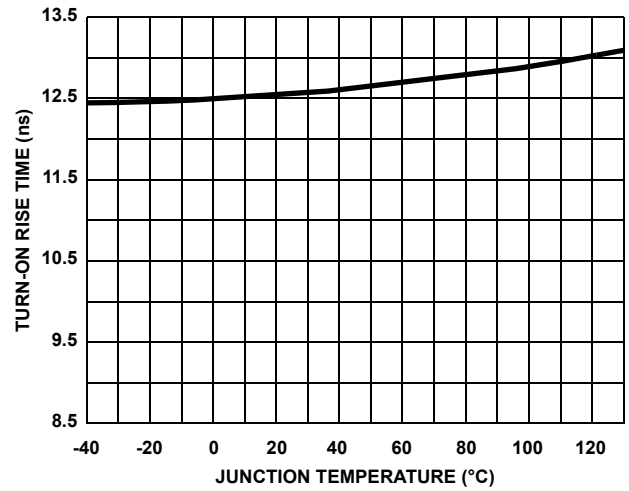

FIGURE 23. GATE DRIVE RISE TIME  $t_r$  vs TEMPERATURE

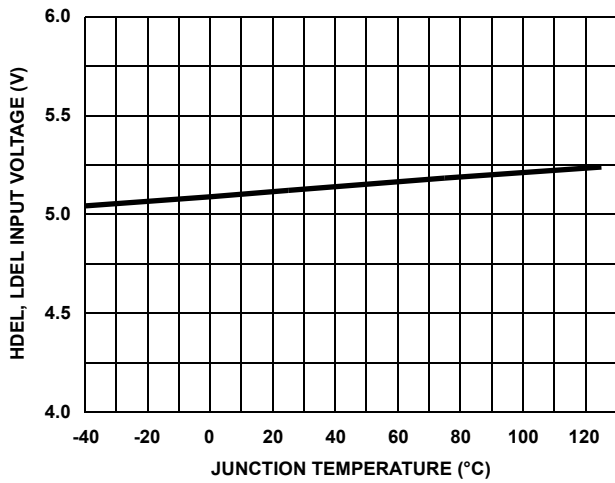

FIGURE 24.  $V_{LDEL}$ ,  $V_{HDEL}$  VOLTAGE vs TEMPERATURE

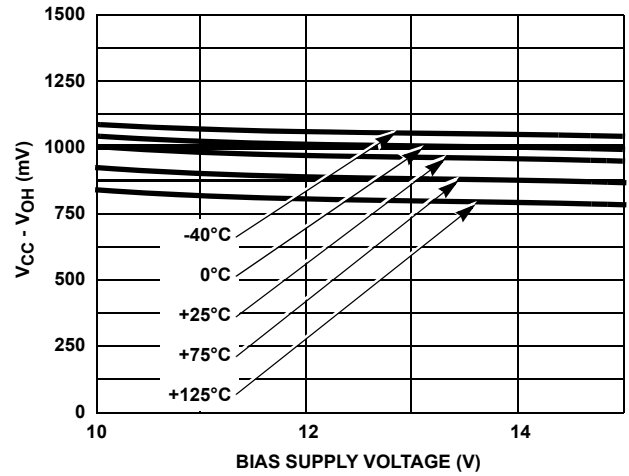

FIGURE 25. HIGH LEVEL OUTPUT VOLTAGE,  $V_{CC} - V_{OH}$  vs BIAS SUPPLY AND TEMPERATURE AT  $100\mu A$

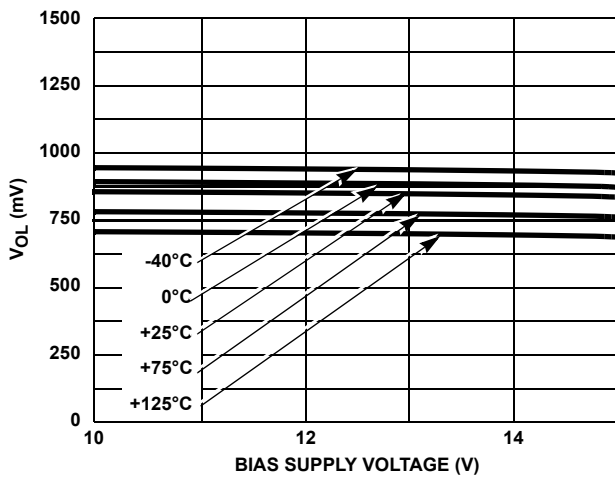

FIGURE 26. LOW LEVEL OUTPUT VOLTAGE  $V_{OL}$  vs BIAS SUPPLY AND TEMPERATURE AT  $100\mu A$

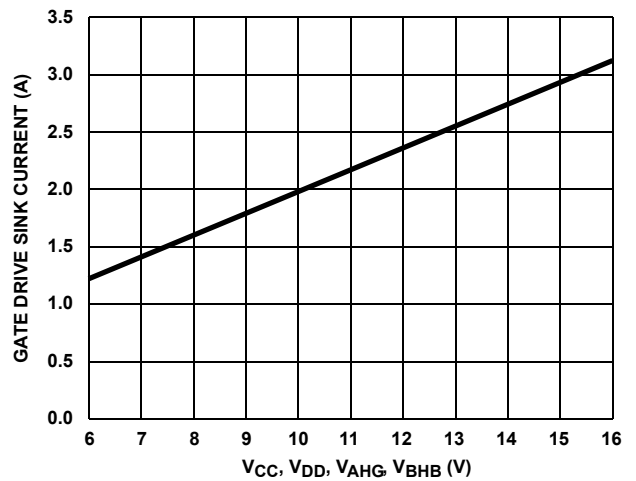

FIGURE 27. PEAK PULLDOWN CURRENT  $I_O$ . BIAS SUPPLY VOLTAGE

**Typical Performance Curves**  $V_{DD} = V_{CC} = V_{AHB} = V_{BHB} = 12V$ ,  $V_{SS} = V_{ALS} = V_{BLS} = V_{AHS} = V_{BHS} = 0V$ ,  $R_{HDEL} = R_{LDEL} = 100K$ , and  $T_A = +25^{\circ}C$ , Unless Otherwise Specified. **(Continued)**

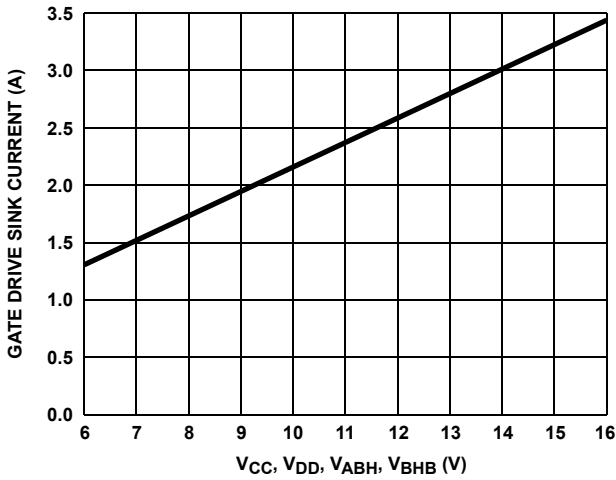

FIGURE 28. PEAK PULLUP CURRENT  $I_{O+}$  vs SUPPLY VOLTAGE

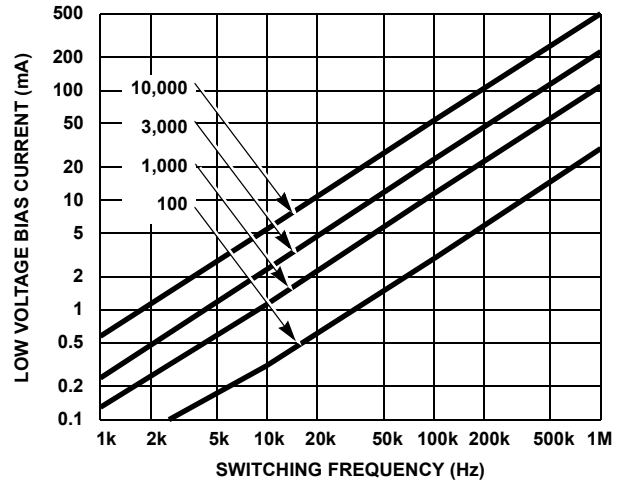

FIGURE 29. LOW VOLTAGE BIAS CURRENT  $I_{DD}$  AND  $I_{CC}$  (LESS QUIESCENT COMPONENT) vs FREQUENCY AND GATE LOAD CAPACITANCE

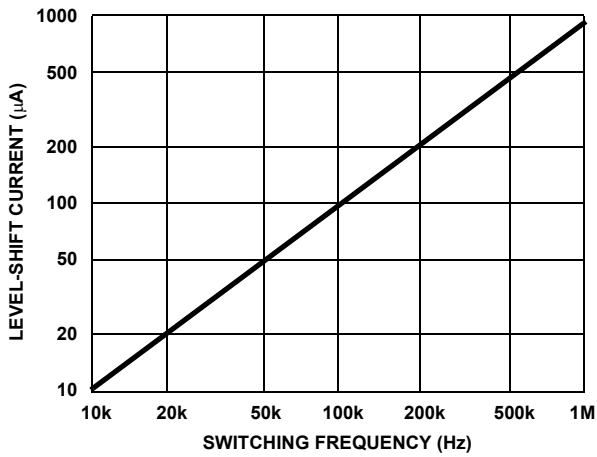

FIGURE 30. HIGH VOLTAGE LEVEL-SHIFT CURRENT vs FREQUENCY AND BUS VOLTAGE

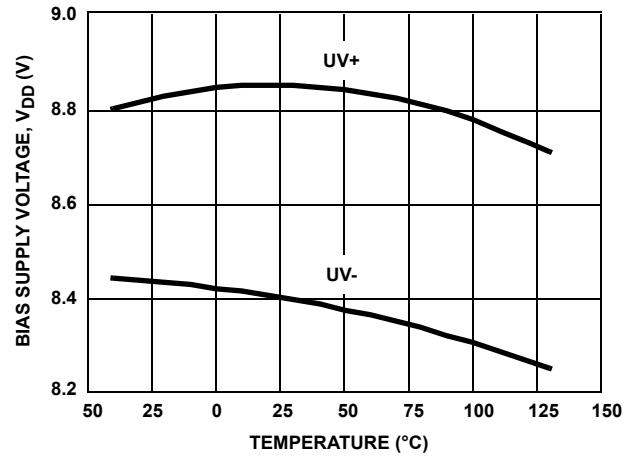

FIGURE 31. UNDERVOLTAGE LOCKOUT vs TEMPERATURE

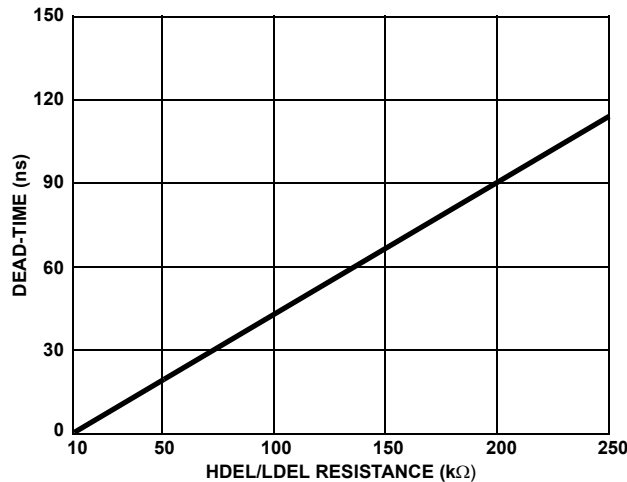
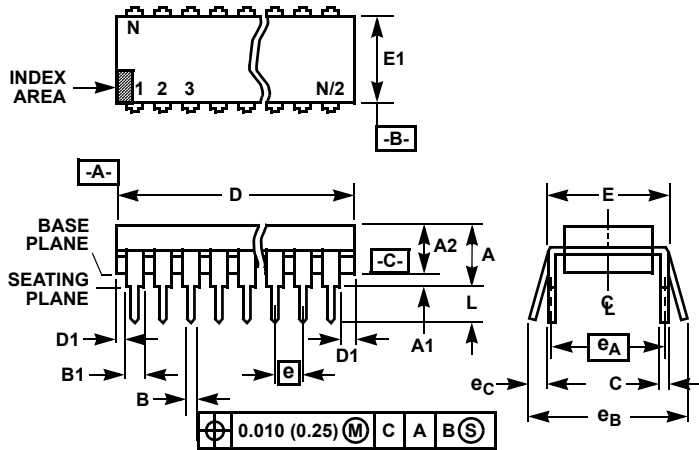

FIGURE 32. MINIMUM DEAD-TIME vs DEL RESISTANCE

**Dual-In-Line Plastic Packages (PDIP)**



**NOTES:**

1. Controlling Dimensions: INCH. In case of conflict between English and Metric dimensions, the inch dimensions control.
2. Dimensioning and tolerancing per ANSI Y14.5M-1982.
3. Symbols are defined in the "MO Series Symbol List" in Section 2.2 of Publication No. 95.
4. Dimensions A, A1 and L are measured with the package seated in JEDEC seating plane gauge GS-3.
5. D, D1, and E1 dimensions do not include mold flash or protrusions. Mold flash or protrusions shall not exceed 0.010 inch (0.25mm).
6. E and e<sub>A</sub> are measured with the leads constrained to be perpendicular to datum -C-.
7. e<sub>B</sub> and e<sub>C</sub> are measured at the lead tips with the leads unconstrained. e<sub>C</sub> must be zero or greater.
8. B1 maximum dimensions do not include dambar protrusions. Dambar protrusions shall not exceed 0.010 inch (0.25mm).
9. N is the maximum number of terminal positions.
10. Corner leads (1, N, N/2 and N/2 + 1) for E8.3, E16.3, E18.3, E28.3, E42.6 will have a B1 dimension of 0.030 - 0.045 inch (0.76 - 1.14mm).

**E20.3 (JEDEC MS-001-AD ISSUE D)  
20 LEAD DUAL-IN-LINE PLASTIC PACKAGE**

SYMBOL	INCHES		MILLIMETERS		NOTES
	MIN	MAX	MIN	MAX	
A	-	0.210	-	5.33	4
A1	0.015	-	0.39	-	4
A2	0.115	0.195	2.93	4.95	-
B	0.014	0.022	0.356	0.558	-
B1	0.045	0.070	1.55	1.77	8
C	0.008	0.014	0.204	0.355	-
D	0.980	1.060	24.89	26.9	5
D1	0.005	-	0.13	-	5
E	0.300	0.325	7.62	8.25	6
E1	0.240	0.280	6.10	7.11	5
e	0.100 BSC		2.54 BSC		-
e <sub>A</sub>	0.300 BSC		7.62 BSC		6
e <sub>B</sub>	-	0.430	-	10.92	7
L	0.115	0.150	2.93	3.81	4
N	20		20		9

Rev. 0 12/93

**Small Outline Plastic Packages (SOIC)**

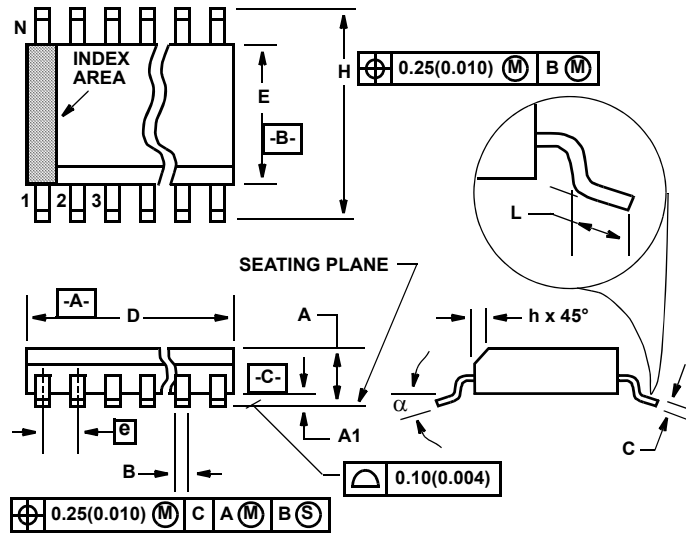

**M20.3 (JEDEC MS-013-AC ISSUE C)  
20 LEAD WIDE BODY SMALL OUTLINE PLASTIC PACKAGE**

SYMBOL	INCHES		MILLIMETERS		NOTES
	MIN	MAX	MIN	MAX	
A	0.0926	0.1043	2.35	2.65	-
A1	0.0040	0.0118	0.10	0.30	-
B	0.014	0.019	0.35	0.49	9
C	0.0091	0.0125	0.23	0.32	-
D	0.4961	0.5118	12.60	13.00	3
E	0.2914	0.2992	7.40	7.60	4
e	0.050 BSC		1.27 BSC		-
H	0.394	0.419	10.00	10.65	-
h	0.010	0.029	0.25	0.75	5
L	0.016	0.050	0.40	1.27	6
N	20		20		7
alpha	0°	8°	0°	8°	-

**NOTES:**

1. Symbols are defined in the "MO Series Symbol List" in Section 2.2 of Publication Number 95.
2. Dimensioning and tolerancing per ANSI Y14.5M-1982.
3. Dimension "D" does not include mold flash, protrusions or gate burrs. Mold flash, protrusion and gate burrs shall not exceed 0.15mm (0.006 inch) per side.
4. Dimension "E" does not include interlead flash or protrusions. Interlead flash and protrusions shall not exceed 0.25mm (0.010 inch) per side.
5. The chamfer on the body is optional. If it is not present, a visual index feature must be located within the crosshatched area.
6. "L" is the length of terminal for soldering to a substrate.
7. "N" is the number of terminal positions.
8. Terminal numbers are shown for reference only.
9. The lead width "B", as measured 0.36mm (0.014 inch) or greater above the seating plane, shall not exceed a maximum value of 0.61mm (0.024 inch)
10. Controlling dimension: MILLIMETER. Converted inch dimensions are not necessarily exact.

Rev. 2 6/05

© Copyright Intersil Americas LLC 2007. All Rights Reserved.

All trademarks and registered trademarks are the property of their respective owners.

For additional products, see [www.intersil.com/en/products.html](http://www.intersil.com/en/products.html)

Intersil products are manufactured, assembled and tested utilizing ISO9001 quality systems as noted in the quality certifications found at [www.intersil.com/en/support/qualandreliability.html](http://www.intersil.com/en/support/qualandreliability.html)

Intersil products are sold by description only. Intersil may modify the circuit design and/or specifications of products at any time without notice, provided that such modification does not, in Intersil's sole judgment, affect the form, fit or function of the product. Accordingly, the reader is cautioned to verify that datasheets are current before placing orders. Information furnished by Intersil is believed to be accurate and reliable. However, no responsibility is assumed by Intersil or its subsidiaries for its use; nor for any infringements of patents or other rights of third parties which may result from its use. No license is granted by implication or otherwise under any patent or patent rights of Intersil or its subsidiaries.

For information regarding Intersil Corporation and its products, see [www.intersil.com](http://www.intersil.com)