

## ISL28271, ISL28272

Dual Micropower, Single Supply, Rail-to-Rail Input and Output (RRIO) Instrumentation Amplifier

Rev X.00

The ISL28271 and ISL28272 are dual micropower instrumentation amplifiers (in-amps) optimized for single supply operation over the +2.4V to +5.5V range.

Both devices feature an Input Range Enhancement Circuit (IREC) which maintains CMRR performance for input voltages equal to the positive and negative supply rails. The input signal is capable of swinging 10% above the positive supply rail and to 100mV below the negative supply with only a slight degradation of the CMRR performance. The output operation is rail-to-rail.

The ISL28271 is compensated for a minimum gain of 10 or more. For higher gain applications, the ISL28272 is compensated for a minimum gain of 100. The in-amps have CMOS input devices for maximum input common voltage range. The amplifiers can be operated from one lithium cell or two Ni-Cd batteries.

### Ordering Information

| PART NUMBER<br>(Note) | PART<br>MARKING     | PACKAGE<br>(Pb-free) | PKG. DWG. # |
|-----------------------|---------------------|----------------------|-------------|
| ISL28271FAZ*          | 28271 FAZ           | 16 Ld QSOP           | MDP0040     |
| ISL28272FAZ*          | 28272 FAZ           | 16 Ld QSOP           | MDP0040     |
| ISL28271INEVAL1Z      | Evaluation Platform |                      |             |
| ISL28272INEVAL1Z      | Evaluation Platform |                      |             |

\*Add "-T7" suffix for tape and reel. Please refer to TB347 for details on reel specifications.

NOTE: These Intersil Pb-free plastic packaged products employ special Pb-free material sets; molding compounds/die attach materials and 100% matte tin plate PLUS ANNEAL - e3 termination finish, which is RoHS compliant and compatible with both SnPb and Pb-free soldering operations. Intersil Pb-free products are MSL classified at Pb-free peak reflow temperatures that meet or exceed the Pb-free requirements of IPC/JEDEC J STD-020.

### Features

- 120µA typical supply current for both channels
- 30pA max input bias current
- 100dB CMRR, PSRR
- 0.7µV/°C offset voltage temperature coefficient
- 180kHz 3dB Bandwidth - ISL28271
- 100kHz 3dB Bandwidth - ISL28272
- 0.5V/µs slew rate
- Single supply operation
- Rail-to-rail input and output (RRIO)
- Input is capable of swinging above V+ and below V- (ground sensing)
- 0.081%1 typical gain error - ISL28271
- -0.19%1 typical gain error - ISL28272
- Pb-free available (RoHS compliant)

### Applications

- Battery- or solar-powered systems
- Strain gauge
- Sensor signal conditioning
- Medical devices
- Industrial instrumentations

### Related Literature

- AN1290, ISL2827xINEVAL1Z Evaluation Board User's Guide
- AN1298, Instrumentation Amplifier Application Note

### Pinout

ISL28271, ISL28272  
(16 LD QSOP)  
TOP VIEW

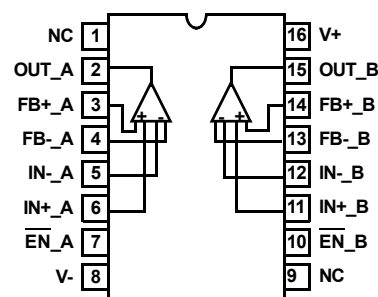

**Absolute Maximum Ratings** ( $T_A = +25^\circ\text{C}$ )

|  |                        |
|--|------------------------|
| Supply Voltage                               | 5.5V                   |
| Supply Turn-on Voltage Slew Rate             | 1V/ $\mu\text{s}$      |
| Input Current (IN, FB) ISL28272              | 5mA                    |
| Differential Input Voltage (IN, FB) ISL28272 | 0.5V                   |
| Input Current (IN, FB) ISL28271              | 5mA                    |
| Differential Input (IN, FB) Voltage ISL28271 | 1.0V                   |
| Input Voltage                                | V- - 0.5V to V+ + 0.5V |
| ESD Rating                                   |                        |
| Human Body Model                             | .3kV                   |
| Machine Model                                | .300V                  |

**Thermal Information**

|                                     |   |
|-------------------------------------|---|
| Thermal Resistance                  | $\theta_{JA}$ ( $^\circ\text{C}/\text{W}$ )   |
| 16 Ld QSOP Package                  | 112   |
| Output Short-Circuit Duration       | Indefinite  |
| Ambient Operating Temperature Range | -40 $^\circ\text{C}$ to +125 $^\circ\text{C}$   |
| Storage Temperature Range           | -65 $^\circ\text{C}$ to +150 $^\circ\text{C}$   |
| Operating Junction Temperature      | +125 $^\circ\text{C}$   |
| Pb-free reflow profile              | see link below  |
|                                     | <a href="http://www.intersil.com/pbfree/Pb-FreeReflow.asp">http://www.intersil.com/pbfree/Pb-FreeReflow.asp</a> |

**CAUTION:** Do not operate at or near the maximum ratings listed for extended periods of time. Exposure to such conditions may adversely impact product reliability and result in failures not covered by warranty.

**IMPORTANT NOTE:** All parameters having Min/Max specifications are guaranteed. Typical values are for information purposes only. Unless otherwise noted, all tests are at the specified temperature and are pulsed tests, therefore:  $T_J = T_C = T_A$

**Electrical Specifications**  $V_+ = +5\text{V}$ ,  $V_- = \text{GND}$ ,  $V_{FB+} = 1/2V_+$ ,  $R_L = \text{Open}$ ,  $T_A = +25^\circ\text{C}$ , unless otherwise specified. **Boldface limits apply over the operating temperature range, -40 $^\circ\text{C}$  to +125 $^\circ\text{C}$ .**

| PARAMETER  | DESCRIPTION  | CONDITIONS   |                                   | MIN<br>(Note 1)      | TYP      | MAX<br>(Note 1)    | UNIT                         |
|------------|--|--|-----------------------------------|----------------------|----------|--------------------|------------------------------|
| $V_{OS}$   | Input Offset Voltage   | ISL28271   |                                   | -600<br><b>-1200</b> | $\pm 35$ | 600<br><b>1200</b> | $\mu\text{V}$                |
|            |  | ISL28272   |                                   | -500<br><b>-750</b>  | $\pm 35$ | 500<br><b>750</b>  | $\mu\text{V}$                |
| $TCV_{OS}$ | Input Offset Voltage Temperature Coefficient -40 $^\circ\text{C}$ to +125 $^\circ\text{C}$ |  |                                   |                      | 0.7      |                    | $\mu\text{V}/^\circ\text{C}$ |
| $I_{OS}$   | Input Offset Current between IN+ and IN-, and between FB+ and FB-                          | See graphs for extended temperature range -40 $^\circ\text{C}$ to +85 $^\circ\text{C}$ |                                   | -30<br><b>-80</b>    | $\pm 5$  | 30<br><b>80</b>    | pA                           |
| $I_B$      | Input Bias Current (IN+, IN-, FB+, and FB- terminals)                                      | See graphs for extended temperature range -40 $^\circ\text{C}$ to +85 $^\circ\text{C}$ |                                   | -30<br><b>-80</b>    | $\pm 10$ | 30<br><b>80</b>    | pA                           |
| $e_N$      | Input Noise Voltage  | ISL28271   | $f = 0.1\text{Hz}$ to 10Hz        |                      | 10       |                    | $\mu\text{V}_{P-P}$          |
|            |  | ISL28272   |                                   |                      | 6        |                    | $\mu\text{V}_{P-P}$          |
|            | Input Noise Voltage Density  | ISL28271   | $f_o = 1\text{kHz}$               |                      | 240      |                    | $\text{nV}/\sqrt{\text{Hz}}$ |
|            |  | ISL28272   |                                   |                      | 78       |                    | $\text{nV}/\sqrt{\text{Hz}}$ |
| $i_N$      | Input Noise Current Density  | ISL28271   | $f_o = 1\text{kHz}$               |                      | 0.92     |                    | $\text{pA}/\sqrt{\text{Hz}}$ |
|            |  | ISL28272   |                                   |                      | 0.2      |                    | $\text{pA}/\sqrt{\text{Hz}}$ |
| $R_{IN}$   | Input Resistance   |  |                                   |                      | 1        |                    | $\text{G}\Omega$             |
| $V_{IN}$   | Input Voltage Range  | $V_+ = 2.4\text{V}$ to 5.0V  |                                   | 0                    |          | $V_+$              | V                            |
| CMRR       | Common Mode Rejection Ratio  | ISL28271   | $V_{CM} = 0\text{V}$ to 5V        | 80<br><b>70</b>      | 100      |                    | dB                           |
|            |  | ISL28272   |                                   | 80<br><b>75</b>      | 100      |                    | dB                           |
| PSRR       | Power Supply Rejection Ratio   | $V_+ = 2.4\text{V}$ to 5V  |                                   | 80<br><b>75</b>      | 100      |                    | dB                           |
| $E_G$      | Gain Error   | ISL28271   | $R_L = 100\text{k}\Omega$ to 2.5V |                      | +0.081   |                    | %                            |
|            |  | ISL28272   |                                   |                      | -0.19    |                    | %                            |

**Electrical Specifications**  $V_+ = +5V$ ,  $V_- = GND$ ,  $V_{FB+} = 1/2V_+$ ,  $R_L = \text{Open}$ ,  $T_A = +25^\circ\text{C}$ , unless otherwise specified. **Boldface limits apply over the operating temperature range,  $-40^\circ\text{C}$  to  $+125^\circ\text{C}$ . (Continued)**

| PARAMETER    | DESCRIPTION                           | CONDITIONS  |          | MIN<br>(Note 1)       | TYP  | MAX<br>(Note 1)       | UNIT             |
|--------------|---------------------------------------|---|----------|-----------------------|------|-----------------------|------------------|
| $V_{OUT}$    | Maximum Voltage Swing                 | Output low, $R_L = 100k\Omega$                        |          |                       | 3    | <b>6</b><br><b>30</b> | mV               |
|              |                                       | Output low, $R_L = 1k\Omega$                          |          |                       | 130  | 175<br><b>225</b>     | mV               |
|              |                                       | Output high, $R_L = 100k\Omega$                       |          | 4.980<br><b>4.980</b> | 4.99 |                       | V                |
|              |                                       | Output high, $R_L = 1k\Omega$                         |          | 4.85<br><b>4.80</b>   | 4.88 |                       | V                |
| SR           | Slew Rate                             | $R_L = 1k\Omega$ to GND                               |          | 0.4<br><b>0.35</b>    | 0.5  | 0.7<br><b>0.75</b>    | V/ $\mu\text{s}$ |
| -3dB BW      | -3dB Bandwidth                        | $R_L = 10k\Omega$                                     | ISL28271 |                       | 180  |                       | kHz              |
|              |                                       |   | ISL28272 |                       | 100  |                       | kHz              |
| $I_{S,EN}$   | Supply Current, Enabled               | Both A and B channels enabled, $\overline{EN} = V_-$  |          |                       | 120  | 156<br><b>200</b>     | $\mu\text{A}$    |
| $I_{S,DIS}$  | Supply Current, Disabled              | Both A and B channels disabled, $\overline{EN} = V_+$ |          |                       | 4    | 7<br><b>9</b>         | $\mu\text{A}$    |
| $V_{INH}$    | $\overline{EN}$ Enable Pin High Level |   |          | <b>2</b>              |      |                       | V                |
| $V_{INL}$    | $\overline{EN}$ Enable Pin Low Level  |   |          |                       |      | <b>0.8</b>            | V                |
| $I_{ENH}$    | $\overline{EN}$ Input Current High    | $\overline{EN} = V_+$                                 |          |                       | 0.8  | 1<br><b>1.3</b>       | $\mu\text{A}$    |
| $I_{ENL}$    | $\overline{EN}$ Input Current Low     | $\overline{EN} = V_-$                                 |          |                       | 26   | 50<br><b>100</b>      | nA               |
| $V_{SUPPLY}$ | Supply Operating Range                | $V_+$ to $V_-$ (Note 2)                               |          | 2.4                   |      | 5.5                   | V                |
| $I_{SC+}$    | Short Circuit Output Current          | $V_+ = 5V$ , $R_L = 10\Omega$                         |          | 28<br><b>25</b>       | 31   |                       | mA               |
| $I_{SC-}$    | Short Circuit Output Current          | $V_+ = 5V$ , $R_L = 10\Omega$                         |          | 24<br><b>20</b>       | 26   |                       | mA               |

## NOTE:

- Parts are 100% tested at  $+25^\circ\text{C}$ . Over temperature limits established by characterization and are not production tested.
- $V_{SUPPLY} = +5.25V$  max when  $V_{ENL} = +V$  (device in disable state).

**Typical Performance Curves**  $V_+ = +5V$ ,  $V_- = GND$ ,  $V_{FB+} = 1/2V_+$ ,  $R_L = Open$ ,  $T_A = +25^\circ C$ , unless otherwise specified.

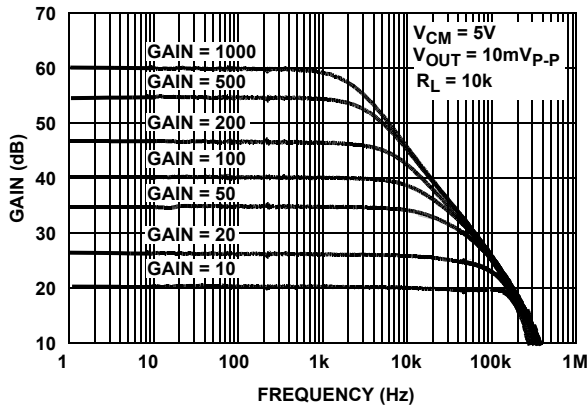

FIGURE 1. ISL28271 FREQUENCY RESPONSE vs CLOSED LOOP GAIN,  $V_+ = V_{CM} = 5V$

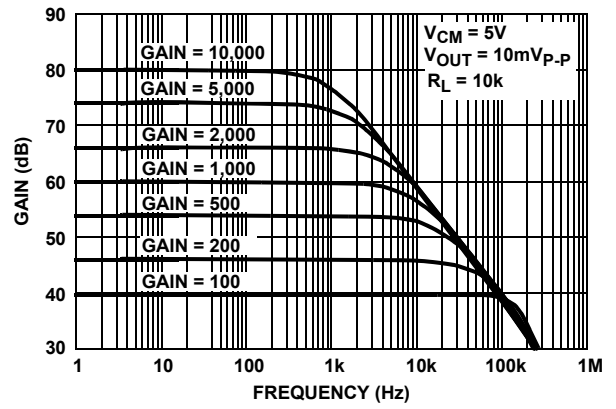

FIGURE 2. ISL28272 FREQUENCY RESPONSE vs CLOSED LOOP GAIN,  $V_{CM} = V_+$

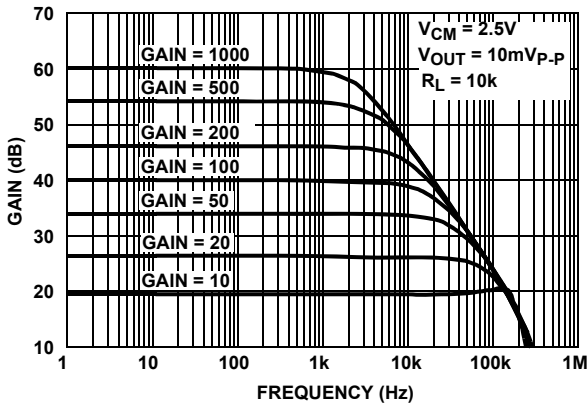

FIGURE 3. ISL28271 FREQUENCY RESPONSE vs CLOSED LOOP GAIN,  $V_+ = 5V$ ,  $V_{CM} = 1/2V_+$

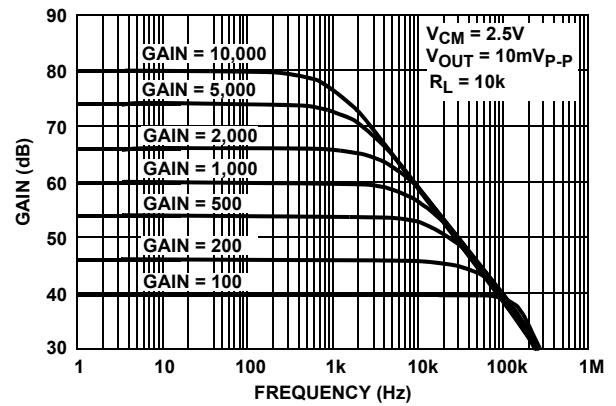

FIGURE 4. ISL28272 FREQUENCY RESPONSE vs CLOSED LOOP GAIN,  $V_{CM} = 1/2V_+$

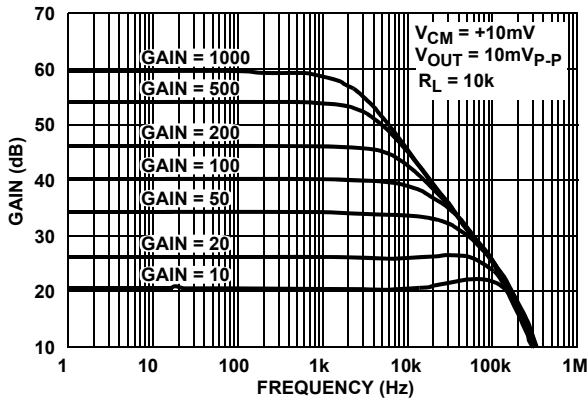

FIGURE 5. ISL28271 FREQUENCY RESPONSE vs CLOSED LOOP GAIN,  $V_+ = 5V$ ,  $V_{CM} = 10mV$

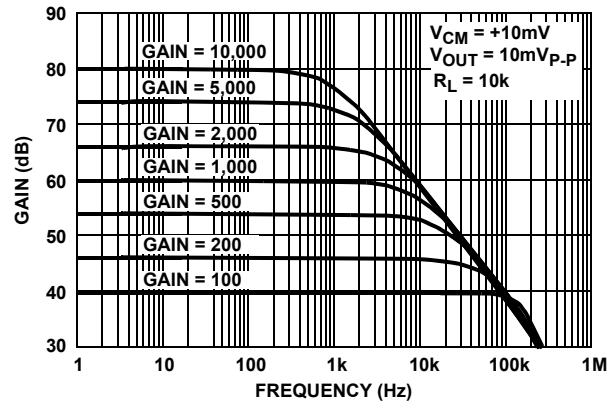

FIGURE 6. ISL28272 FREQUENCY RESPONSE vs CLOSED LOOP GAIN,  $V_{CM} = V_-$

**Typical Performance Curves**  $V_+ = +5V, V_- = GND, V_{FB+} = 1/2V_+, R_L = \text{Open}, T_A = +25^\circ\text{C}$ , unless otherwise specified.

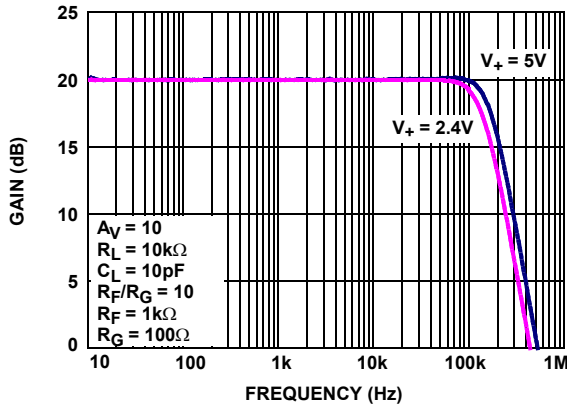

FIGURE 7. ISL28271 FREQUENCY RESPONSE vs SUPPLY VOLTAGE

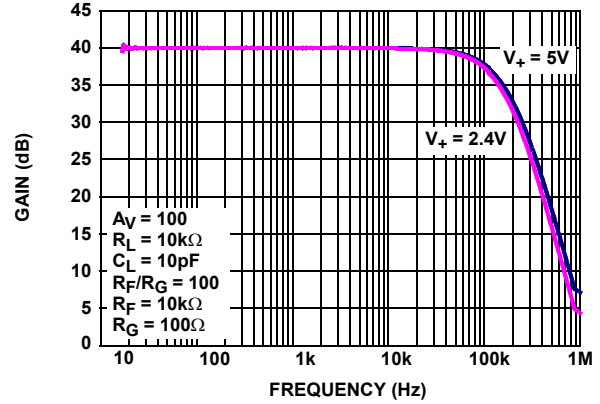

FIGURE 8. ISL28272 FREQUENCY RESPONSE vs SUPPLY VOLTAGE

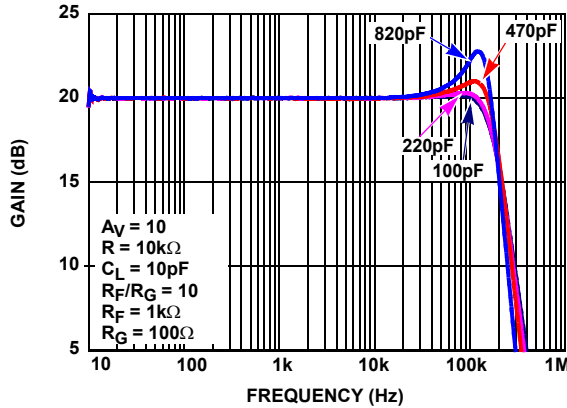

FIGURE 9. ISL28271 FREQUENCY RESPONSE vs  $C_{LOAD}$

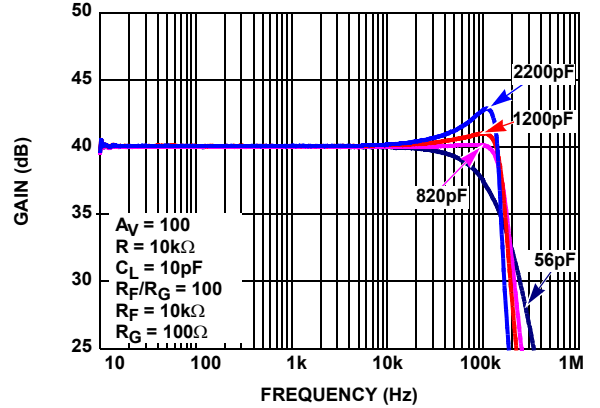

FIGURE 10. ISL28272 FREQUENCY RESPONSE vs  $C_{LOAD}$

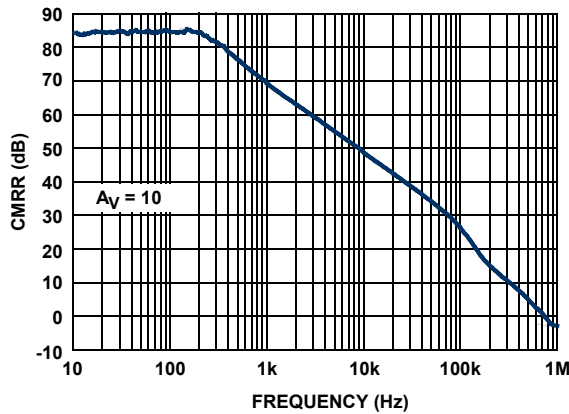

FIGURE 11. ISL28271 CMRR vs FREQUENCY

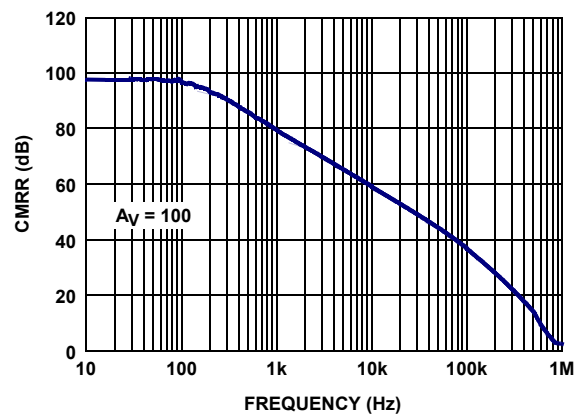

FIGURE 12. ISL28272 CMRR vs FREQUENCY

**Typical Performance Curves**  $V_+ = +5V$ ,  $V_- = GND$ ,  $V_{FB+} = 1/2V_+$ ,  $R_L = Open$ ,  $T_A = +25^\circ C$ , unless otherwise specified.

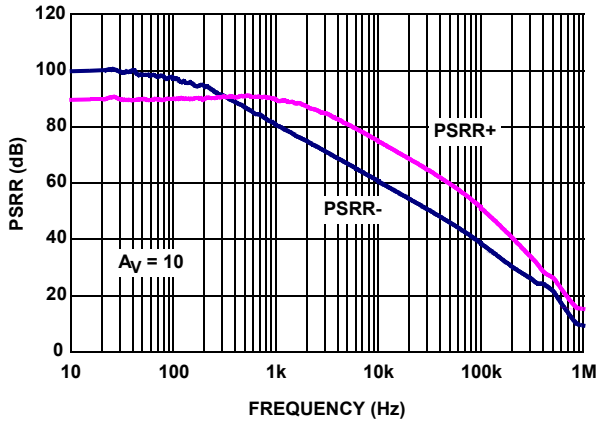

FIGURE 13. ISL28271 PSRR vs FREQUENCY

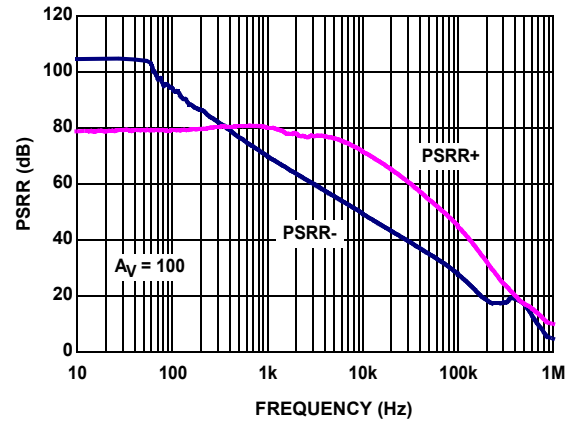

FIGURE 14. ISL28272 PSRR vs FREQUENCY

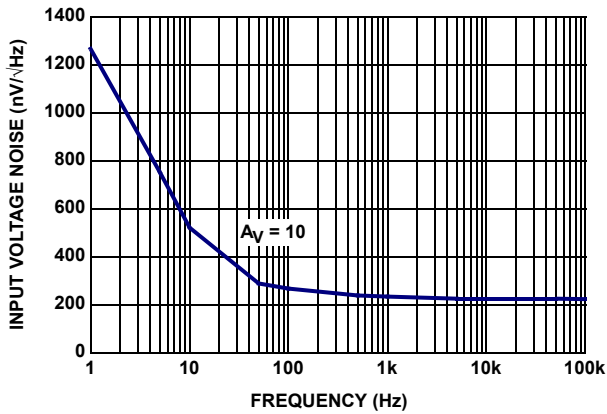

FIGURE 15. ISL28271 INPUT VOLTAGE NOISE SPECTRAL DENSITY

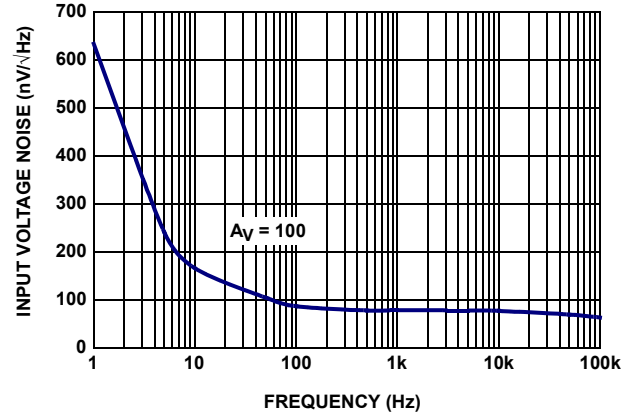

FIGURE 16. ISL28272 INPUT VOLTAGE NOISE SPECTRAL DENSITY

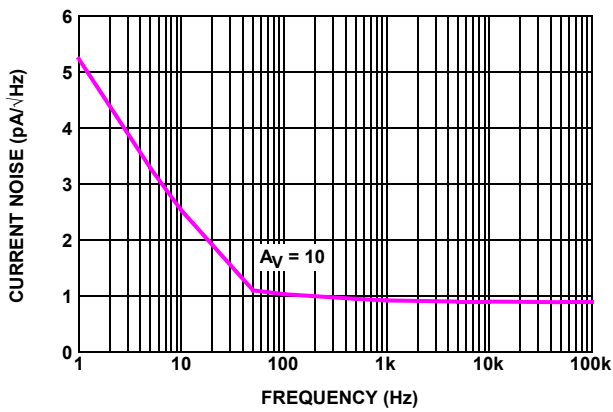

FIGURE 17. ISL28271 INPUT CURRENT NOISE SPECTRAL DENSITY

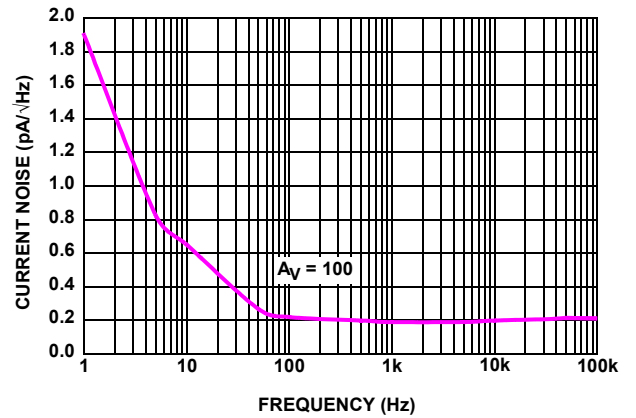

FIGURE 18. ISL28272 INPUT CURRENT NOISE SPECTRAL DENSITY

**Typical Performance Curves**  $V_+ = +5V$ ,  $V_- = GND$ ,  $V_{FB+} = 1/2V_+$ ,  $R_L = Open$ ,  $T_A = +25^\circ C$ , unless otherwise specified.

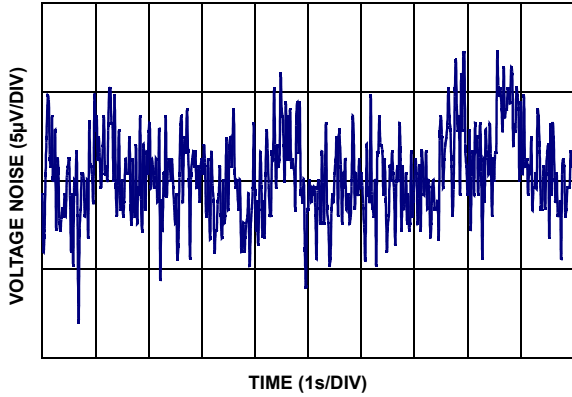

FIGURE 19. ISL28271 0.1Hz TO 10Hz INPUT VOLTAGE NOISE, GAIN = 10

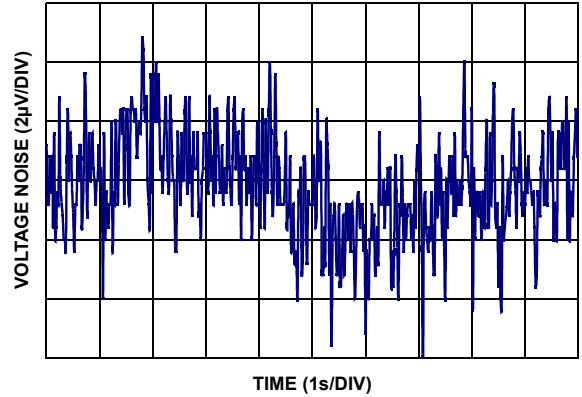

FIGURE 20. ISL28272 0.1Hz TO 10Hz INPUT VOLTAGE NOISE, GAIN = 100

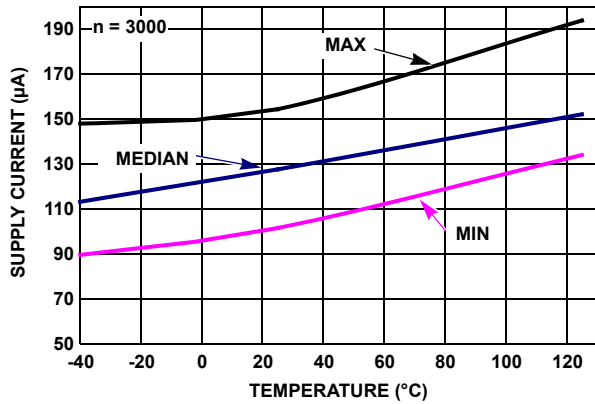

FIGURE 21. ISL28271 SUPPLY CURRENT ENABLED vs TEMPERATURE,  $V_+ = V_- = \pm 2.5V$ ,  $V_{IN} = 0V$

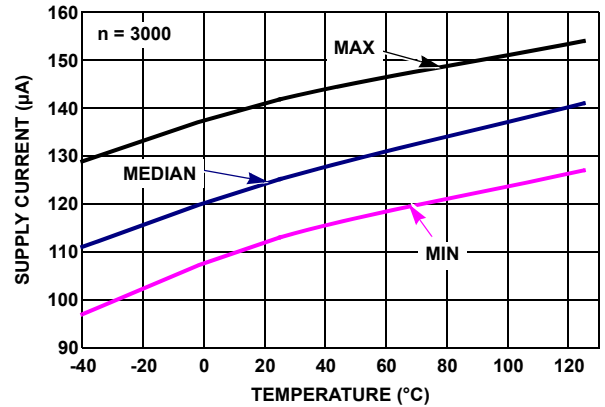

FIGURE 22. ISL28272 SUPPLY CURRENT ENABLED vs TEMPERATURE,  $V_+ = V_- = \pm 2.5V$ ,  $V_{IN} = 0V$

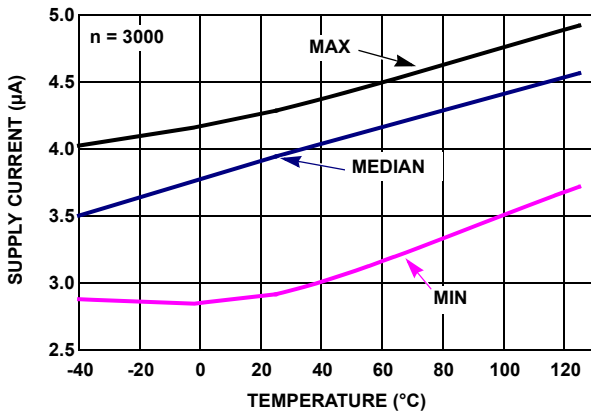

FIGURE 23. ISL28271 SUPPLY CURRENT DISABLED vs TEMPERATURE,  $V_+ = V_- = \pm 2.5V$ ,  $V_{IN} = 0V$

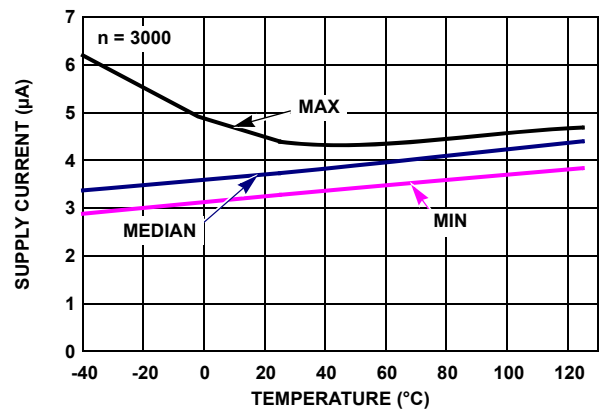

FIGURE 24. ISL28272 SUPPLY CURRENT DISABLED vs TEMPERATURE,  $V_+ = V_- = \pm 2.5V$ ,  $V_{IN} = 0V$

**Typical Performance Curves**  $V_+ = +5V, V_- = GND, V_{FB+} = 1/2V_+, R_L = \text{Open}, T_A = +25^\circ\text{C}$ , unless otherwise specified.

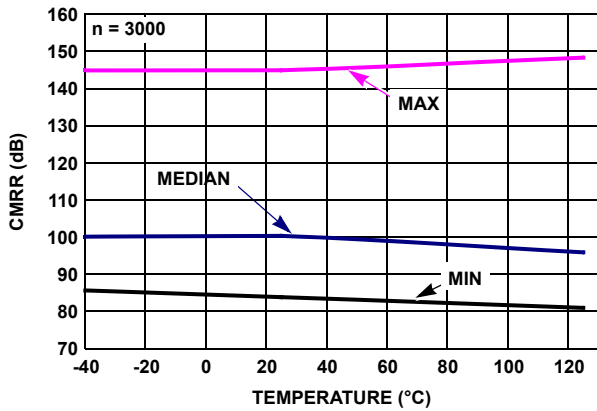

FIGURE 25. ISL28271 CMRR vs TEMPERATURE,  $V_{CM} = +2.5V$  TO  $-2.5V$

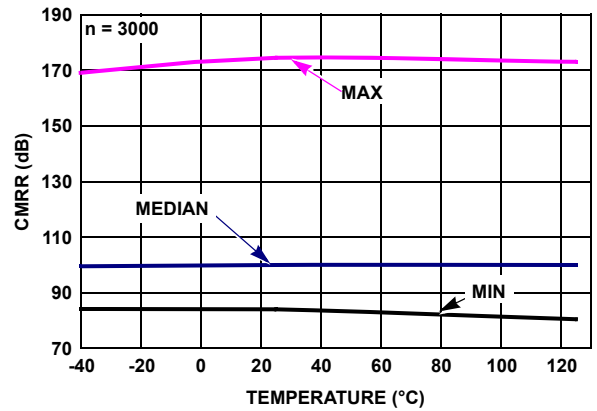

FIGURE 26. ISL28272 CMRR vs TEMPERATURE,  $V_{CM} = +2.5V$  TO  $-2.5V$

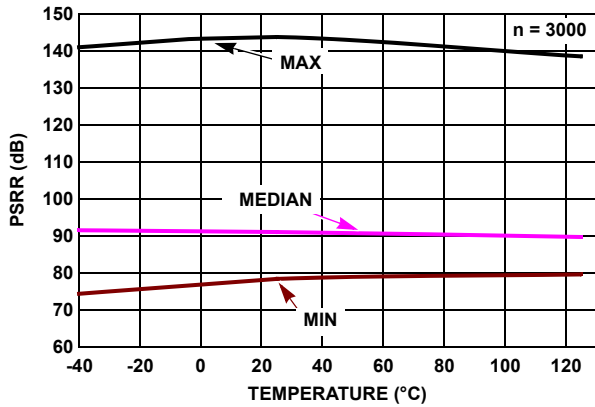

FIGURE 27. ISL28271 PSRR vs TEMPERATURE,  $V_+, V_- = \pm 1.2V$  TO  $\pm 2.5V$

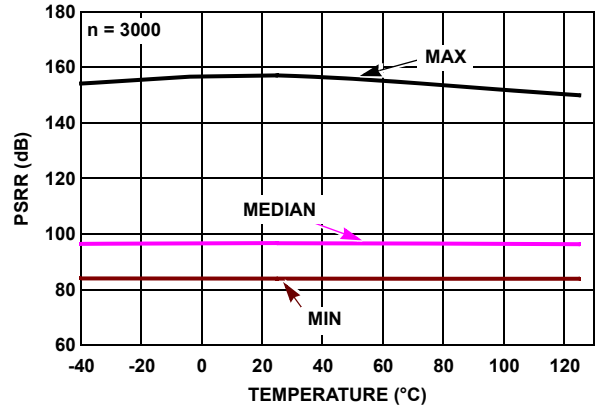

FIGURE 28. ISL28272 PSRR vs TEMPERATURE,  $V_+, V_- = \pm 1.2V$  TO  $\pm 2.5V$

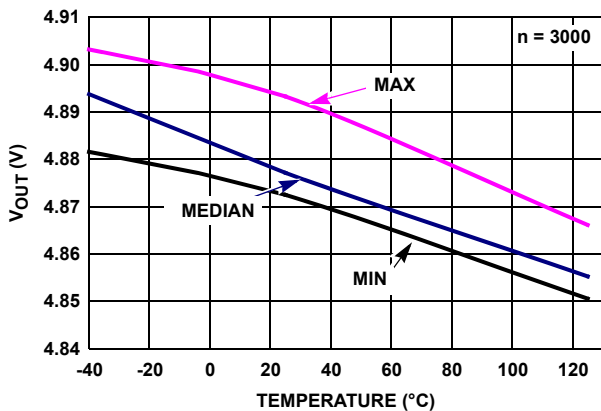

FIGURE 29. ISL28271  $V_{OUT}$  HIGH vs TEMPERATURE,  $R_L = 1k, V_+, V_- = \pm 2.5V$

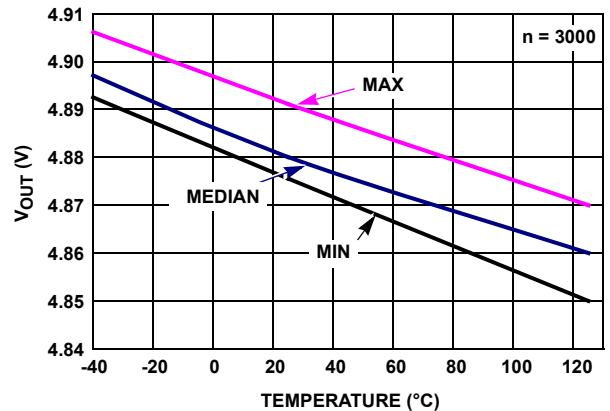

FIGURE 30. ISL28272  $V_{OUT}$  HIGH vs TEMPERATURE,  $R_L = 1k, V_+, V_- = \pm 2.5V$



**Typical Performance Curves**  $V_+ = +5V$ ,  $V_- = GND$ ,  $V_{FB+} = 1/2V_+$ ,  $R_L = Open$ ,  $T_A = +25^\circ C$ , unless otherwise specified.

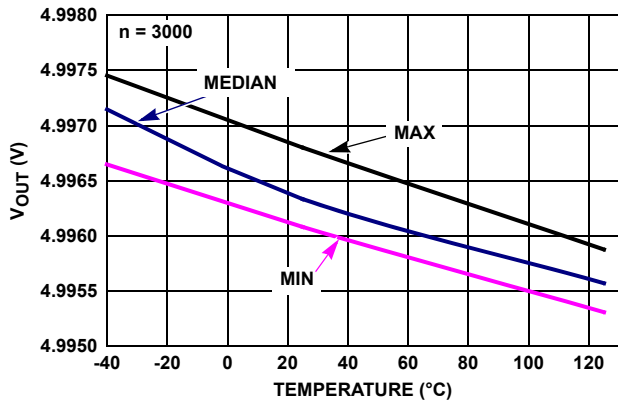

FIGURE 31. ISL28271  $V_{OUT}$  HIGH vs TEMPERATURE,  $R_L = 100k$ ,  $V_+ = V_- = \pm 2.5V$

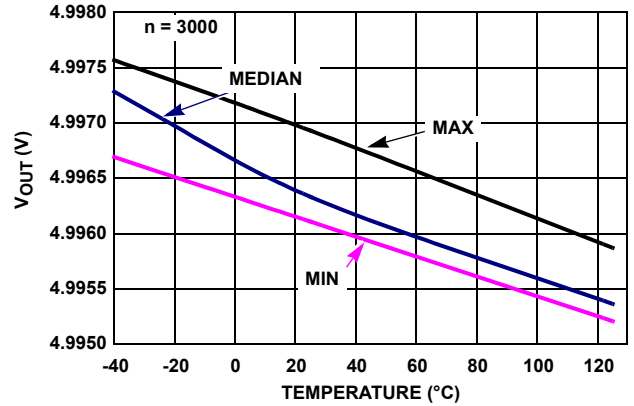

FIGURE 32. ISL28272  $V_{OUT}$  HIGH vs TEMPERATURE,  $R_L = 100k$ ,  $V_+ = V_- = \pm 2.5V$

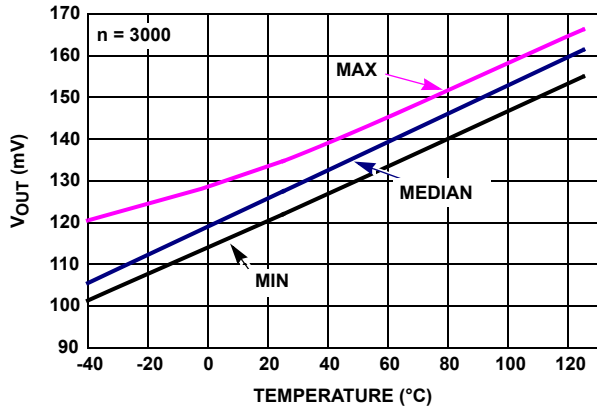

FIGURE 33. ISL28271  $V_{OUT}$  LOW vs TEMPERATURE,  $R_L = 1k$ ,  $V_+ = V_- = \pm 2.5V$

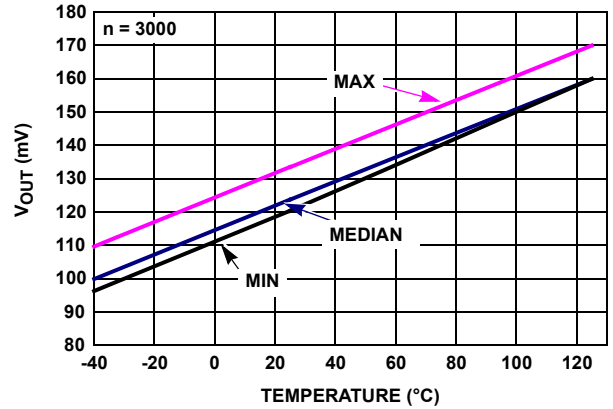

FIGURE 34. ISL28272  $V_{OUT}$  LOW vs TEMPERATURE,  $R_L = 1k$ ,  $V_+ = V_- = \pm 2.5V$

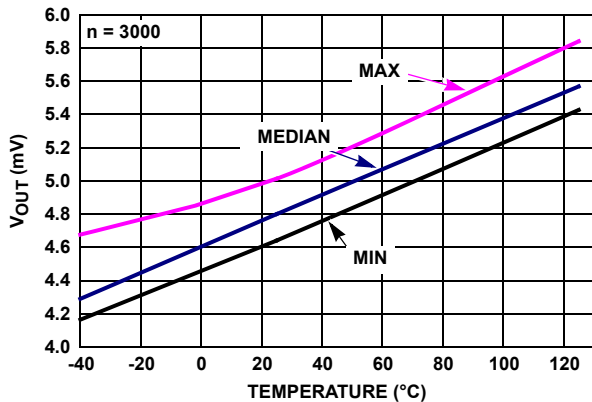

FIGURE 35. ISL28271  $V_{OUT}$  LOW vs TEMPERATURE,  $R_L = 100k$ ,  $V_+ = V_- = \pm 2.5V$

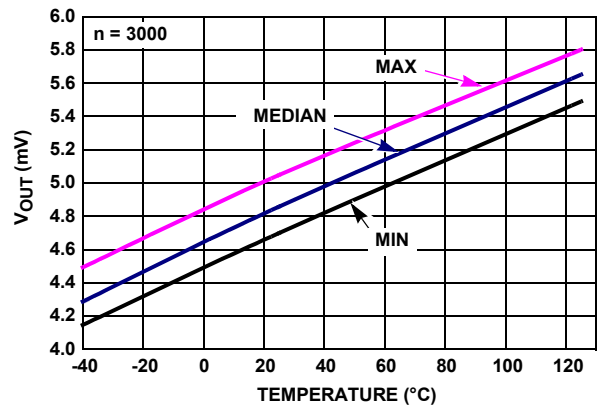
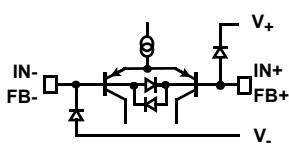

FIGURE 36. ISL28272  $V_{OUT}$  LOW vs TEMPERATURE,  $R_L = 100k$ ,  $V_+ = V_- = \pm 2.5V$

**Pin Descriptions**

| ISL28271<br>16 Ld QSOP | ISL28272<br>16 Ld QSOP | PIN NAME   | EQUIVALENT<br>CIRCUIT     | PIN FUNCTION  |
|------------------------|------------------------|--|---------------------------|---|
| 2, 15                  | 2, 15                  | OUT_A,<br>OUT_B  | Circuit 3                 | Output Voltage. A complementary Class AB common-source output stage drives the output of each channel. When disabled, the outputs are in a high impedance state.  |
| 3, 14                  | 3, 14                  | FB+_A,<br>FB+_B  | Circuit 1A,<br>Circuit 1B | Positive Feedback high impedance terminals. ISL28272 input circuit is shown in Circuit 1A, and the ISL28271 input circuit is shown in Circuit 1B.<br><br>ISL28271: to avoid offset drift, it is recommended that the terminals of the ISL28271 are not overdriven beyond 1V and the input current must never exceed 5mA.  |
| 4, 13                  | 4, 13                  | FB-_A,<br>FB-_B  | Circuit 1A,<br>Circuit 1B | Negative Feedback high impedance terminals. The FB- pins connect to an external resistor divider to individually set the desired gain of the in-amp. ISL28272 input circuit is shown in Circuit 1A, and the ISL28271 input circuit is shown in Circuit 1B.<br><br>ISL28271: to avoid offset drift, it is recommended that the terminals of the ISL28271 are not overdriven beyond 1V and the input current must never exceed 5mA. |
| 5, 12                  | 5, 12                  | IN-_A,<br>IN-_B  | Circuit 1A,<br>Circuit 1B | High impedance Inverting input terminals. Connect to the low side of the input source signal. ISL28272 input circuit is shown in Circuit 1A, and the ISL28271 input circuit is shown in Circuit 1B.<br><br>ISL28271: to avoid offset drift, it is recommended that the terminals of the ISL28271 are not overdriven beyond 1V and the input current must never exceed 5mA.  |
| 6, 11                  | 6, 11                  | IN+_A,<br>IN+_B  | Circuit 1A,<br>Circuit 1B | High impedance Non-inverting input terminals. Connect to the high side of the input source signal. ISL28272 input circuit is shown in Circuit 1A, and the ISL28271 input circuit is shown in Circuit 1B.<br><br>ISL28271: to avoid offset drift, it is recommended that the terminals of the ISL28271 are not overdriven beyond 1V and the input current must never exceed 5mA.   |
| 7, 10                  | 7, 10                  | $\overline{\text{EN}}_A$ ,<br>$\overline{\text{EN}}_B$ | Circuit 2                 | Active LOW logic pins. When pulled above 2V, the corresponding channel turns off and OUT is high impedance. A channel is enabled when pulled below 0.8V. Built-in pull downs define each $\overline{\text{EN}}$ pin LOW when left floating.   |
| 16                     | 16                     | V+   | Circuit 4                 | Positive Supply terminal shared by all channels.  |
| 8                      | 8                      | V-   | Circuit 4                 | Negative Supply terminal shared by all channels. Grounded for single supply operation.  |
| 1, 9                   | 1, 9                   | NC   |                           | No Connect, pins can be left floating or grounded.  |



CIRCUIT 1A

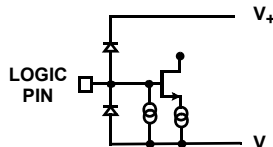

CIRCUIT 2

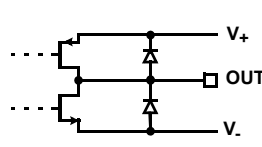

CIRCUIT 3

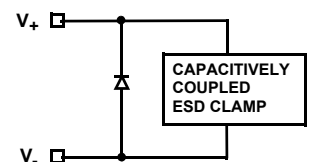

CIRCUIT 4

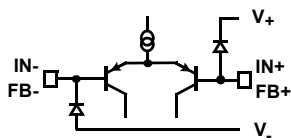

CIRCUIT 1B

## Application Information

### Product Description

The ISL28271 and ISL28272 are dual channel micropower instrumentation amplifiers (in-amps) which deliver rail-to-rail input amplification and rail-to-rail output swing. The in-amps also deliver excellent DC and AC specifications while consuming only about 120µA for both channels. Because the independent pair of feedback terminals set the gain and adjust the output zero level, the ISL28271 and ISL28272 achieve high CMRR regardless of the tolerance of the gain setting resistors. The ISL28271 is internally compensated for a minimum gain of 10. The ISL28272 is internally compensated for a minimum gain of 100.

$\overline{\text{EN}}$  pins are available to independently enable or disable a channel. When all channels are off, current consumption is down to typically 4µA.

### Input Protection

All input terminals and feedback terminals have internal ESD protection diodes to both positive and negative supply rails, limiting the input voltage to within one diode beyond the supply rails. Input signals originating from low impedance sources should have current limiting resistors in series with the IN+ and IN- pins to prevent damaging currents during power supply sequencing and other transient conditions. The ISL28272 has additional back-to-back diodes across the input terminals and also across the feedback terminals. If overdriving the inputs is necessary, the external input current must never exceed 5mA. External series resistors may be used as an external protection to limit excessive external voltage and current from damaging the inputs. On the other hand, the ISL28271 has no clamps to limit the differential voltage on the input terminals allowing higher differential input voltages at lower gain applications. It is recommended however, that the terminals of the ISL28271 are not overdriven beyond 1V to avoid offset drift.

### Input Stage and Input Voltage Range

The input terminals (IN+ and IN-) of the in-amps are a single differential pair of CMOS devices aided by an Input Range Enhancement Circuit, IREC, to increase the headroom of operation of the common-mode input voltage. The feedback terminals (FB+ and FB-) also have a similar topology. As a result, the input common-mode voltage range is rail-to-rail regardless of the feedback terminal settings and regardless of the gain settings. They are able to handle input voltages that are at or slightly beyond the supply and ground sensing making these in-amps well suited for single 5V down to 2.4V supply systems.

The IREC enables rail-to-rail input amplification without the problems usually associated with the dual differential stage topology. The IREC ensures that there are no drastic changes in offset voltage over the entire range of the input. See Input Offset Voltage vs Common-Mode Input Voltage in performance

charts. IREC also cures the abrupt change and even reverse polarity of the input bias current over the whole range of input.

### Output Stage and Output Voltage Range

A Class AB common-source output stage drives the output. The pair of complementary MOSFET devices drive the output VOUT to within a few millivolts of the supply rails. At a 100kΩ load, the PMOS sources current and pulls the output up to 4mV below the positive supply. The NMOS sinks current and pulls the output down to 4mV above the negative supply, or ground in the case of a single supply operation. The current sinking and sourcing capability are internally limited to 31mA. When disabled, the outputs are in a high impedance state.

### Gain Setting

VIN, the potential difference across IN+ and IN-, is replicated (less the input offset voltage) across FB+ and FB-. The function of the in-amp is to maintain the differential voltage across FB- and FB+ equal to IN+ and IN-; (FB- - FB+) = (IN+ - IN-). Consequently, the transfer function can be derived. The in-amp gain is set by two external resistors, the feedback resistor RF, and the gain resistor RG.

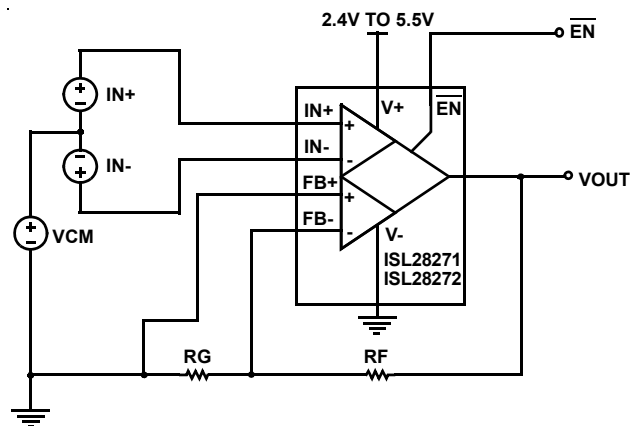

FIGURE 37. GAIN IS SET BY TWO EXTERNAL RESISTORS, RF AND RG

$$V_{IN} = IN+ - IN-$$

$$V_{OUT} = \left( 1 + \frac{R_F}{R_G} \right) V_{IN} \quad (\text{EQ. 1})$$

In Figure 37, the FB+ pin and one end of resistor RG are connected to GND. With this configuration, Equation 1 is only true for a positive swing in VIN; negative input swings will be ignored because the output will be at ground.

### Reference Connection

Unlike a three op amp in-amp realization, a finite series resistance seen at the REF terminal does not degrade the high CMRR performance eliminating the need for an additional external buffer amplifier. Figure 38 uses the FB+ pin to provide a high impedance REF terminal.

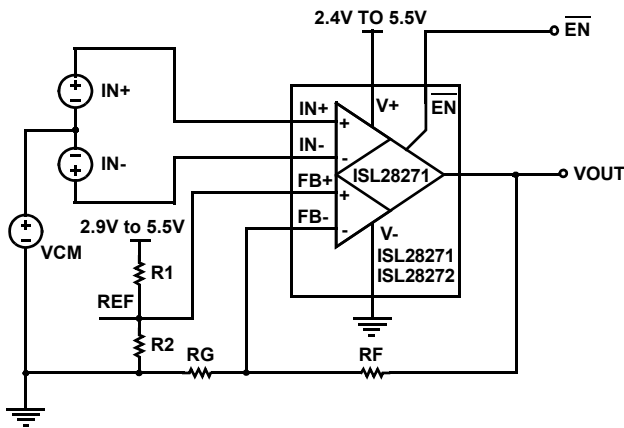

FIGURE 38. GAIN SETTING AND REFERENCE CONNECTION

$$V_{IN} = IN+ - IN-$$

$$V_{OUT} = \left(1 + \frac{R_F}{R_G}\right)(V_{IN}) + \left(1 + \frac{R_F}{R_G}\right)(V_{REF}) \quad (EQ. 2)$$

The FB+ pin is used as a REF terminal to center or to adjust the output. Because the FB+ pin is a high impedance input, an economical resistor divider can be used to set the voltage at the REF terminal without degrading or affecting the CMRR performance. Any voltage applied to the REF terminal will shift VOUT by VREF times the closed loop gain, which is set by resistors RF and RG. See Figure 38.

The FB+ pin can also be connected to the other end of resistor, RG. See Figure 39. Keeping the basic concept that the in-amp maintains constant differential voltage across the input terminals and feedback terminals (FB- - FB+) = (IN+ - IN-), the transfer function of Figure 39 can be derived.

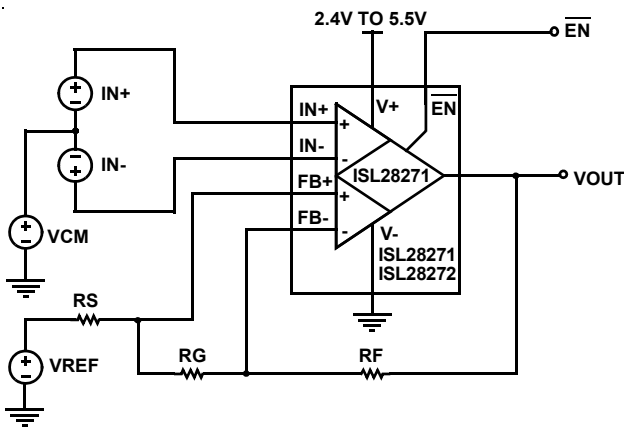

FIGURE 39. REFERENCE CONNECTION WITH AN AVAILABLE VREF

$$V_{IN} = IN+ - IN-$$

$$V_{OUT} = \left[1 + \frac{R_S + R_F}{R_G}\right] + V_{REF} \quad (EQ. 3)$$

$$V_{OUT} = \left(1 + \frac{R_F}{R_G}\right)(V_{IN}) + (V_{REF}) \quad (EQ. 4)$$

A finite resistance RS in series with the VREF source, adds an output offset of VIN\*(RS/RG). As the series resistance RS approaches zero, Equation 3 is simplified to Equation 4 for Figure 39. VOUT is simply shifted by an amount VREF.

### External Resistor Mismatches

Because of the independent pair of feedback terminals provided by the in-amps, the CMRR is not degraded by any resistor mismatches. Hence, unlike a three op amp and especially a two op amp in-amp realization, the ISL28271 and ISL28272 reduce the cost of external components by allowing the use of 1% or more tolerance resistors without sacrificing CMRR performance. The CMRR will be typically 110dB regardless of the tolerance of the resistors used. Instead, a resistor mismatch results in a higher deviation from the theoretical gain - Gain Error.

### Gain Error and Accuracy

The gain error indicated in the “Electrical Specifications” table on page 2 is the inherent gain error alone. The gain error specification listed does not include the gain error contributed by the resistors. There is an additional gain error due to the tolerance of the resistors used. The resulting non-ideal transfer function effectively becomes:

$$V_{OUT} = \left(1 + \frac{R_F}{R_G}\right) \times [1 \pm (E_{RG} + E_{RF} + E_G)] \times V_{IN} \quad (EQ. 5)$$

Where:

ERG = Tolerance of RG

ERF = Tolerance of RF

EG = Gain Error of the ISL28271

The term [1 - (ERG + ERF + EG)] is the deviation from the theoretical gain. Thus, (ERG + ERF + EG) is the total gain error. For example, if 1% resistors are used, the total gain error would be:

$$\text{TotalGainError} = \pm(E_{RG} + E_{RF} + E_G(\text{typical}))$$

$$\text{TotalGainError} = \pm(0.01 + 0.01 + 0.005) = \pm 2.5\%$$

### Disable/Power-Down

The ISL28271 and ISL28272 have an enable/disable pin for each channel. They can be powered down to reduce the supply current to typically 4µA when all channels are off. When disabled, the corresponding output is in a high impedance state. The active low EN pin has an internal pull down and hence can be left floating and the in-amp enabled by default. When the EN is connected to an external logic, the in-amp will shutdown when EN pin is pulled above 2V, and will power up when EN bar is pulled below 0.8V.

**Unused Channels**

The ISL28271 and ISL28272 are Dual channel op amps. If the application only requires one channel when using the ISL28271 or ISL28272, the user must configure the unused channel to prevent it from oscillating. The unused channel will oscillate if the input and output pins are floating. This will result in higher than expected supply currents and possible noise injection into the channel being used. The proper way to prevent this oscillation is to configure the feedback pins (FB+, FB-) with the minimum gain stable values for the amplifier with  $R_F$  and  $R_G$  resistors and tying the input terminals to ground (as shown in Figure 40).

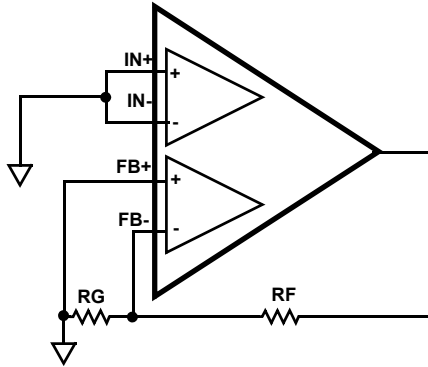
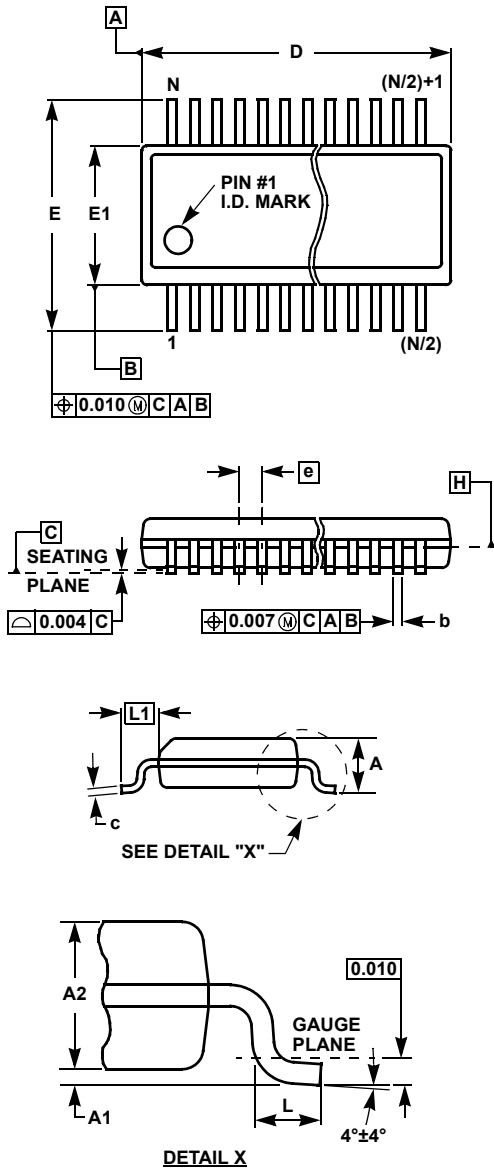

FIGURE 40. PREVENTING OSCILLATIONS IN UNUSED CHANNELS

**Quarter Size Outline Plastic Packages Family (QSOP)**



**MDP0040**

**QUARTER SIZE OUTLINE PLASTIC PACKAGES FAMILY**

| SYMBOL | INCHES |        |        | TOLERANCE | NOTES |
|--------|--------|--------|--------|-----------|-------|
|        | QSOP16 | QSOP24 | QSOP28 |           |       |
| A      | 0.068  | 0.068  | 0.068  | Max.      | -     |
| A1     | 0.006  | 0.006  | 0.006  | ±0.002    | -     |
| A2     | 0.056  | 0.056  | 0.056  | ±0.004    | -     |
| b      | 0.010  | 0.010  | 0.010  | ±0.002    | -     |
| c      | 0.008  | 0.008  | 0.008  | ±0.001    | -     |
| D      | 0.193  | 0.341  | 0.390  | ±0.004    | 1, 3  |
| E      | 0.236  | 0.236  | 0.236  | ±0.008    | -     |
| E1     | 0.154  | 0.154  | 0.154  | ±0.004    | 2, 3  |
| e      | 0.025  | 0.025  | 0.025  | Basic     | -     |
| L      | 0.025  | 0.025  | 0.025  | ±0.009    | -     |
| L1     | 0.041  | 0.041  | 0.041  | Basic     | -     |
| N      | 16     | 24     | 28     | Reference | -     |

Rev. F 2/07

**NOTES:**

1. Plastic or metal protrusions of 0.006" maximum per side are not included.
2. Plastic interlead protrusions of 0.010" maximum per side are not included.
3. Dimensions "D" and "E1" are measured at Datum Plane "H".
4. Dimensioning and tolerancing per ASME Y14.5M-1994.

© Copyright Intersil Americas LLC 2006-2007. All Rights Reserved.  
 All trademarks and registered trademarks are the property of their respective owners.

For additional products, see [www.intersil.com/en/products.html](http://www.intersil.com/en/products.html)

Intersil products are manufactured, assembled and tested utilizing ISO9001 quality systems as noted in the quality certifications found at [www.intersil.com/en/support/qualandreliability.html](http://www.intersil.com/en/support/qualandreliability.html)

Intersil products are sold by description only. Intersil may modify the circuit design and/or specifications of products at any time without notice, provided that such modification does not, in Intersil's sole judgment, affect the form, fit or function of the product. Accordingly, the reader is cautioned to verify that datasheets are current before placing orders. Information furnished by Intersil is believed to be accurate and reliable. However, no responsibility is assumed by Intersil or its subsidiaries for its use; nor for any infringements of patents or other rights of third parties which may result from its use. No license is granted by implication or otherwise under any patent or patent rights of Intersil or its subsidiaries.

For information regarding Intersil Corporation and its products, see [www.intersil.com](http://www.intersil.com)