

**NOT RECOMMENDED FOR NEW DESIGNS
NO RECOMMENDED REPLACEMENT**
 contact our Technical Support Center at
 1-888-INTERSIL or www.intersil.com/tsc

ISL28270, ISL28273, ISL28470

FN6260
 Rev 6.00
 October 21, 2009

Dual and Quad Channel Micropower, Single Supply, Rail-to-Rail
 Input and Output (RRIO) Instrumentation Amplifiers

The ISL28270 and ISL28273 are dual channel micropower instrumentation amplifiers (in-amps) and the ISL28470 is a quad channel in-amp optimized for single supply operation over the +2.4V to +5.5V range.

All three devices feature an Input Range Enhancement Circuit (IREC) which maintains CMRR performance for input voltages equal to the positive supply and down to 50mV above the negative supply rail. The input signal is capable of swinging above the positive supply rail and to 10mV above the negative supply with only a slight degradation of the CMRR performance. The output operation is rail-to-rail.

The ISL28273 is compensated for a minimum gain of 10 or more. For higher gain applications, the ISL28270 and ISL28470 are compensated for a minimum gain of 100. The in-amps have bipolar input devices for best offset and excellent 1/f noise performance. The amplifiers can be operated from one lithium cell or two Ni-Cd batteries.

Ordering Information

PART NUMBER (Note)	PART MARKING	PACKAGE (Pb-Free)	PKG. DWG. #
ISL28270IAZ	28270 IAZ	16 Ld QSOP	MDP0040
ISL28270IAZ-T13*	28270 IAZ	16 Ld QSOP	MDP0040
ISL28273FAZ	28273 FAZ	16 Ld QSOP	MDP0040
ISL28273FAZ-T7*	28273 FAZ	16 Ld QSOP	MDP0040
ISL28470FAZ	ISL28470 FAZ	28 Ld QSOP	MDP0040
ISL28470FAZ-T7 *	ISL28470 FAZ	28 Ld QSOP	MDP0040
ISL28270INEVAL1Z	Evaluation Platform		
ISL28273INEVAL1Z	Evaluation Platform		
ISL28470EVAL1Z	Evaluation Platform		

*Please refer to TB347 for details on reel specifications.

NOTE: Intersil Pb-free plus anneal products employ special Pb-free material sets; molding compounds/die attach materials and 100% matte tin plate termination finish, which are RoHS compliant and compatible with both SnPb and Pb-free soldering operations. Intersil Pb-free products are MSL classified at Pb-free peak reflow temperatures that meet or exceed the Pb-free requirements of IPC/JEDEC J STD-020.

Features

- 150µV Max Offset Voltage (ISL28270, ISL28470)
- 600µV Max Offset Voltage (ISL28273)
- 2.5nA Max Input Bias Current (ISL28270, ISL28470)
- 110dB CMRR
- 0.7µV/°C Offset Voltage Temperature Co-efficient
- 240kHz -3dB Bandwidth (G = 100) ISL28270, ISL28470
- 230kHz -3dB Bandwidth (G = 10) ISL28273
- Single Supply Operation
- Rail-to-Rail Input and Output (RRIO)
- Pb-Free (RoHS Compliant)

Applications

- Battery or Solar-Powered Systems
- Strain Gauge
- Sensor Signal Conditioning
- Medical Devices
- Industrial Instrumentations

Related Literature

- AN1289, ISL28470EVAL1Z Evaluation Board User's Guide
- AN1290, ISL2827xINEVAL1Z Evaluation Board User's Guide
- AN1298, Instrumentation Amplifier Application Note

Pinouts

ISL28270
(16 LD QSOP)
TOP VIEW

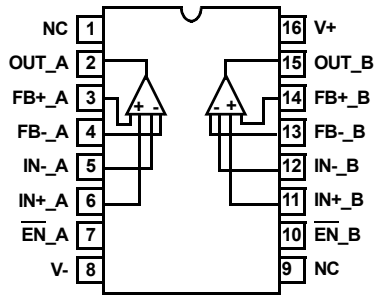

ISL28470
(28 LD QSOP)
TOP VIEW

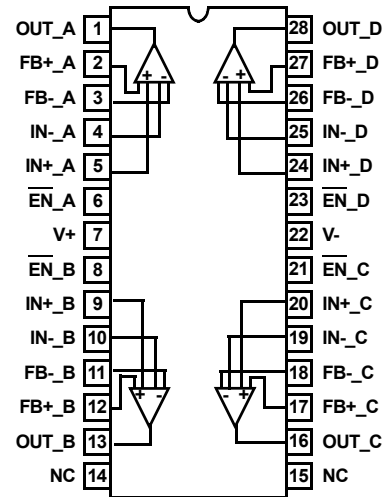

ISL28273
(16 LD QSOP)
TOP VIEW

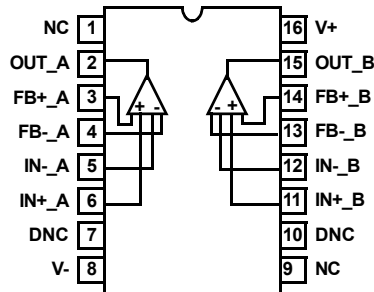

Absolute Maximum Ratings ($T_A = +25^\circ\text{C}$)

Supply Voltage	5.5V
Supply Turn On Voltage Slew Rate	1V/ μs
Input Current (IN, FB) ISL28270, ISL28470	5mA
Differential Input Voltage (IN, FB) ISL28270, ISL28470	0.5V
Input Current (IN, FB) ISL28273	5mA
Differential Input (IN, FB) Voltage ISL28273	1.0V
Input Voltage	V- - 0.5V to V+ + 0.5V
ESD Rating	
Human Body Model	.3kV
Machine Model	.300V

Thermal Information

Thermal Resistance (Typical Note 1)	θ_{JA} ($^\circ\text{C}/\text{W}$)
16 Ld QSOP Package	110
28 Ld QSOP Package	89
Output Short-Circuit Duration	Indefinite
Ambient Operating Temperature Range	-40 $^\circ\text{C}$ to +125 $^\circ\text{C}$
Storage Temperature Range	-65 $^\circ\text{C}$ to +150 $^\circ\text{C}$
Operating Junction Temperature	+125 $^\circ\text{C}$
Pb-free Reflow Profile	see link below
	http://www.intersil.com/pbfree/Pb-FreeReflow.asp

CAUTION: Do not operate at or near the maximum ratings listed for extended periods of time. Exposure to such conditions may adversely impact product reliability and result in failures not covered by warranty.

- θ_{JA} is measured with the component mounted on a high effective thermal conductivity test board in free air. See Tech Brief TB379 for details.

IMPORTANT NOTE: All parameters having Min/Max specifications are guaranteed. Typical values are for information purposes only. Unless otherwise noted, all tests are at the specified temperature and are pulsed tests, therefore: $T_J = T_C = T_A$

Electrical Specifications $V_+ = +5\text{V}$, $V_- = 0\text{V}$ $V_{CM} = 1/2V_+$, $R_L = \text{Open}$, $T_A = +25^\circ\text{C}$, unless otherwise specified.
Boldface limits apply over the operating temperature range, -40 $^\circ\text{C}$ to +125 $^\circ\text{C}$.

PARAMETER	DESCRIPTION	CONDITIONS	MIN (Note 2)	TYP	MAX (Note 2)	UNIT
DC SPECIFICATIONS						
V_{OS}	Input Offset Voltage	ISL28270, ISL28470	-150 -225	± 35	150 225	μV
		ISL28273	-600 -1000	± 12	600 1000	μV
TCV_{OS}	Input Offset Voltage Temperature Coefficient	Temperature = -40 $^\circ\text{C}$ to +125 $^\circ\text{C}$		0.7		$\mu\text{V}/^\circ\text{C}$
I_{OS}	Input Offset Current between IN+ and IN-, and between FB+ and FB-	ISL28270	-1 -1.5	± 0.25	1 1.5	nA
		ISL28470	-1.5 -2.0	± 0.25	1.5 2	nA
		ISL28273	-1 -1.5	± 0.2	1 1.5	nA
I_B	Input Bias Current (IN+, IN-, FB+, and FB- terminals)	ISL28270	-2.0 -2.5	± 0.5	2.0 2.5	nA
		ISL28470	-2.5 -3.0	± 0.5	2.5 3.0	nA
		ISL28273	-2.5 -3.0	± 1	2.5 3.0	nA
R_{IN}	Input Resistance	ISL28270, ISL28470		3		M Ω
		ISL28273		15		M Ω
V_{IN}	Input Voltage Range		0		5	V
CMRR	Common Mode Rejection Ratio	ISL28270	90	110		dB
		ISL28273	85	110		dB
		ISL28470	90 85	110		dB
PSRR	Power Supply Rejection Ratio	ISL28270	90	110		dB
		ISL28273	80 75	95		dB
		ISL28470	90 65	110		dB

Electrical Specifications $V_+ = +5V$, $V_- = 0V$ $V_{CM} = 1/2V_+$, $R_L = \text{Open}$, $T_A = +25^\circ\text{C}$, unless otherwise specified.
Boldface limits apply over the operating temperature range, -40°C to $+125^\circ\text{C}$. (Continued)

PARAMETER	DESCRIPTION	CONDITIONS		MIN (Note 2)	TYP	MAX (Note 2)	UNIT
E_G	Gain Error	ISL28270, ISL28470	$R_L = 100k\Omega$ to VCM		+0.5		%
		ISL28273			+0.12		%
V_{OUT}	Maximum Voltage Swing	Output low, 100k Ω to 2.5V			4	10	mV
		Output low, 1k Ω to 2.5V			130	250 300	mV
		Output high, 100k Ω to 2.5V		4.990	4.996		V
		Output high, 1k Ω to GND		4.75 4.70	4.88		V
$I_{S,EN}$	Supply Current, Enabled	ISL28270, ISL28273 - Both A and B Channels enabled; $\overline{EN} = V_-$			120	156 195	μA
		ISL28470 - A, B, C and D Channels enabled; $\overline{EN} = V_-$			260	335	μA
$I_{S,DIS}$	Supply Current, Disabled (ISL28270, ISL28470 Only)	ISL28270 - Both A & B channels disabled; $\overline{EN} = V_+$			4	7 9	μA
		ISL28470 - A, B, C & D channels disabled; $\overline{EN} = V_+$			10	12 15	μA
V_{ENH}	\overline{EN} Pin for Shut-down (ISL28270, ISL28470 Only)			2			V
V_{ENL}	\overline{EN} Pin for Power-On (ISL28270, ISL28470 Only)					0.8	V
I_{ENH}	\overline{EN} Input Current High (ISL28270, ISL28470 Only)	$\overline{EN} = V_+$			0.8	1 1.3	μA
I_{ENL}	\overline{EN} Input Current Low (ISL28270, ISL28470 Only)	$\overline{EN} = V_-$			26	50 100	nA
V_{SUPPLY}	Supply Operating Range	V_+ to V_-		2.4		5.5	V
I_{SC}	Short Circuit Output Current	$V_+ = 5V$, $R_{LOAD} = 10\Omega$		± 20 ± 18	± 29		mA
AC SPECIFICATIONS							
SR	Slew Rate	$R_L = 1k\Omega$ to GND, ISL28270, ISL28470		0.3 0.25	0.5	0.7 0.75	V/ μs
		$R_L = 1k\Omega$ to GND, ISL28273		0.35 0.3	0.6	0.75 0.8	
-3dB BW	-3dB Bandwidth	ISL28270, ISL28470	Gain = 100		240		kHz
			Gain = 200		84		kHz
			Gain = 500		30		kHz
			Gain = 1000		13		kHz
		ISL28273	Gain = 10		265		kHz
			Gain = 20		100		kHz
			Gain = 50		25		kHz
			Gain = 100		13		kHz
e_N	Input Noise Voltage	ISL28270, ISL28470	$f = 0.1\text{Hz}$ to 10Hz		3.5		μV_{p-p}
		ISL28273			3.5		μV_{p-p}
	Input Noise Voltage Density	ISL28270, ISL28470	$f_o = 1\text{kHz}$		60		nV/ $\sqrt{\text{Hz}}$
		ISL28273			210		nV/ $\sqrt{\text{Hz}}$
i_N	Input Noise Current Density	ISL28270, ISL28sa470	$f_o = 1\text{kHz}$		0.37		pA/ $\sqrt{\text{Hz}}$
		ISL28273			0.75		pA/ $\sqrt{\text{Hz}}$

Electrical Specifications $V_+ = +5V, V_- = 0V, V_{CM} = 1/2V_+, R_L = \text{Open}, T_A = +25^\circ\text{C}$, unless otherwise specified.
Boldface limits apply over the operating temperature range, -40°C to $+125^\circ\text{C}$. (Continued)

PARAMETER	DESCRIPTION	CONDITIONS		MIN (Note 2)	TYP	MAX (Note 2)	UNIT
CMRR @ 60Hz	Input Common Mode Rejection Ratio	ISL28270, ISL28470	$V_{CM} = 1V_{P-P}$ $R_L = 10k\Omega$ to V_{CM}		100		dB
		ISL28273					
PSRR+ @ 120Hz	Power Supply Rejection Ratio (V_+)	ISL28270, ISL28470	$V_+, V_- = \pm 1.2V, \pm 2.5V$ $V_{SOURCE} = 1V_{P-P}$ $R_L = 10k\Omega$ to V_{CM}		96		dB
		ISL28273					
PSRR- @ 120Hz	Power Supply Rejection Ratio (V_-)	ISL28270, ISL28470	$V_+, V_- = \pm 1.2V, \pm 2.5V$ $V_{SOURCE} = 1V_{P-P}$ $R_L = 10k\Omega$ to V_{CM}		105		dB
		ISL28273					

NOTE:

- Parameters with MIN and/or MAX limits are 100% tested at $+25^\circ\text{C}$, unless otherwise specified. Temperature limits established by characterization and are not production tested.

Typical Performance Curves $V_+ = +5V, V_- = 0V, V_{CM} = 1/2V_+, V_{EN} = V_-, R_L = \text{Open}, T_A = +25^\circ\text{C}$, unless otherwise specified.

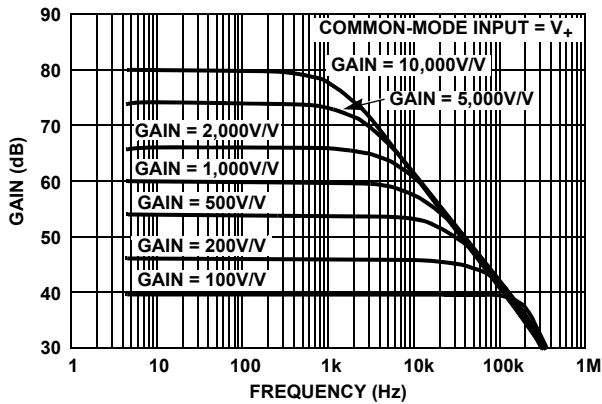

FIGURE 1. ISL28270, ISL28470 FREQUENCY RESPONSE vs CLOSED LOOP GAIN, $V_{CM} = V_+ = 5V$

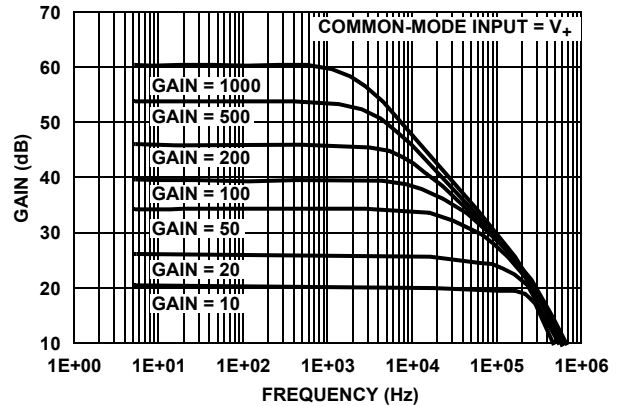

FIGURE 2. ISL28273 FREQUENCY RESPONSE vs CLOSED LOOP GAIN, $V_{CM} = V_+ = 5V$

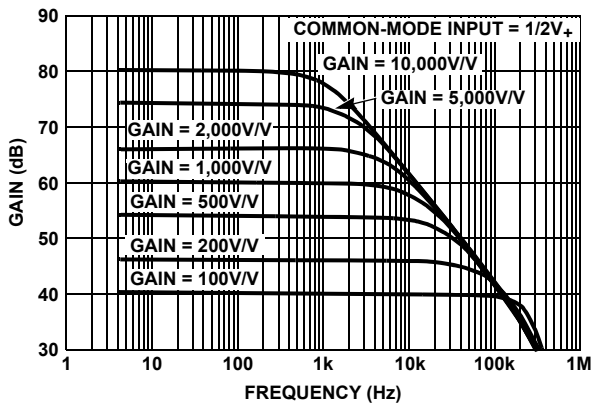

FIGURE 3. ISL28270, ISL28470 FREQUENCY RESPONSE vs CLOSED LOOP GAIN. $V_+ = 5V, V_{CM} = 1/2V_+$

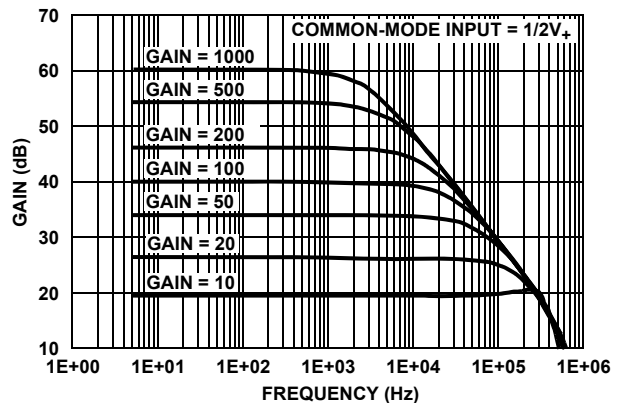

FIGURE 4. ISL28273 FREQUENCY RESPONSE vs CLOSED LOOP GAIN. $V_+ = 5V, V_{CM} = 1/2V_+$

Typical Performance Curves

$V_+ = +5V, V_- = 0V, V_{CM} = 1/2V_+, V_{EN} = V_-, R_L = \text{Open}, T_A = +25^\circ\text{C}$,
 unless otherwise specified. (Continued)

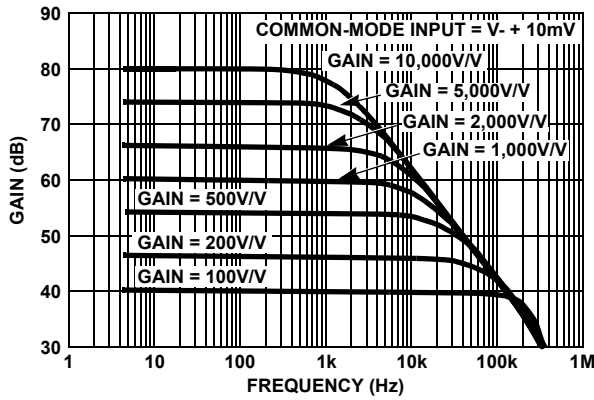

FIGURE 5. ISL28270, ISL28470 FREQUENCY RESPONSE vs CLOSED LOOP GAIN, $V_+ = 5V, V_{CM} = 10mV$

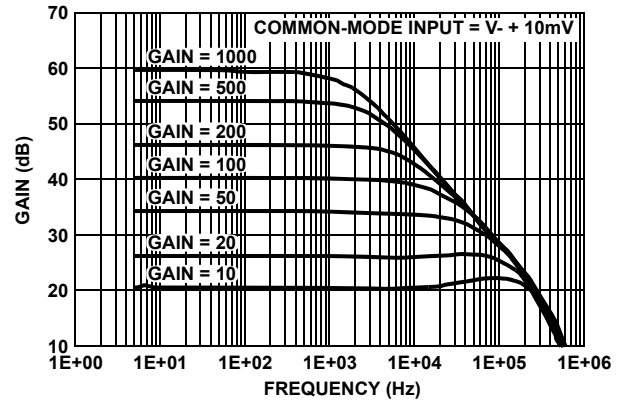

FIGURE 6. ISL28273 FREQUENCY RESPONSE vs CLOSED LOOP GAIN, $V_+ = 5V, V_{CM} = 10mV$

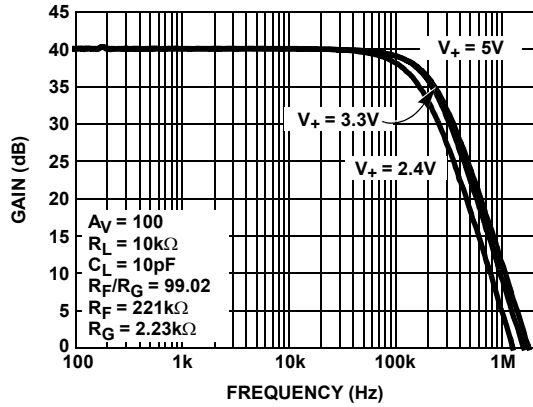

FIGURE 7. ISL28270, ISL28470 FREQUENCY RESPONSE vs SUPPLY VOLTAGE

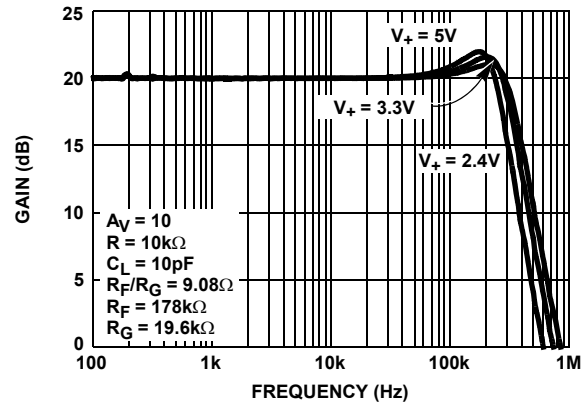

FIGURE 8. ISL28273 FREQUENCY RESPONSE vs SUPPLY VOLTAGE

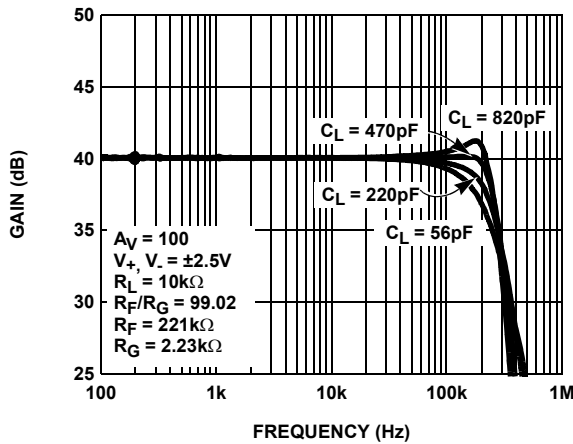

FIGURE 9. ISL28270, ISL28470 FREQUENCY RESPONSE vs C_{LOAD}

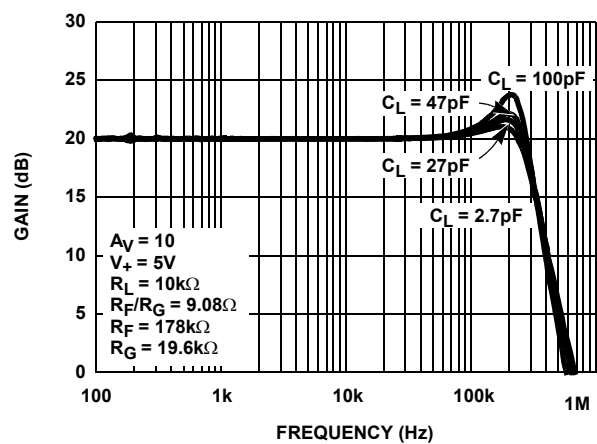

FIGURE 10. ISL28273 FREQUENCY RESPONSE vs C_{LOAD}

Typical Performance Curves

$V_+ = +5V$, $V_- = 0V$, $V_{CM} = 1/2V_+$, $V_{EN} = V_-$, $R_L = \text{Open}$, $T_A = +25^\circ\text{C}$, unless otherwise specified. (Continued)

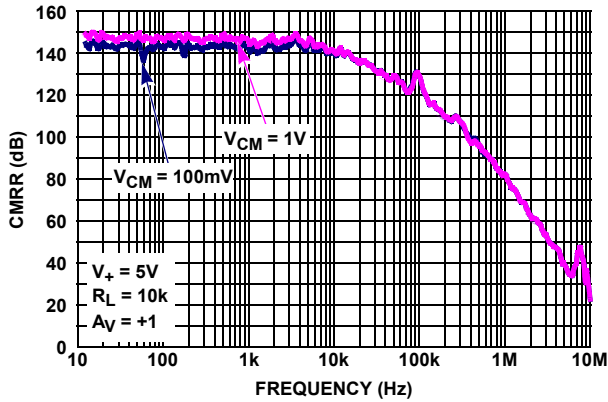

FIGURE 11. ISL28270, ISL28470 CMRR vs FREQUENCY

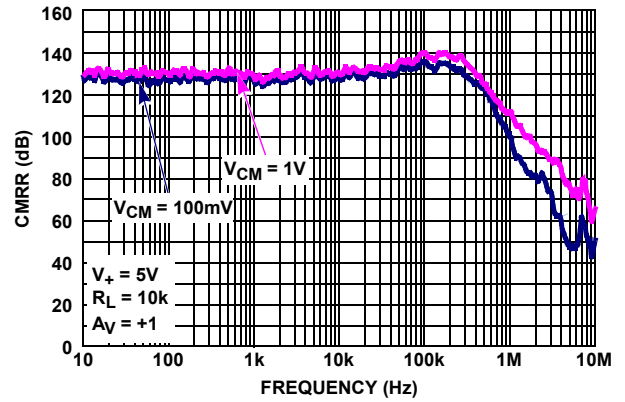

FIGURE 12. ISL28273 CMRR vs FREQUENCY

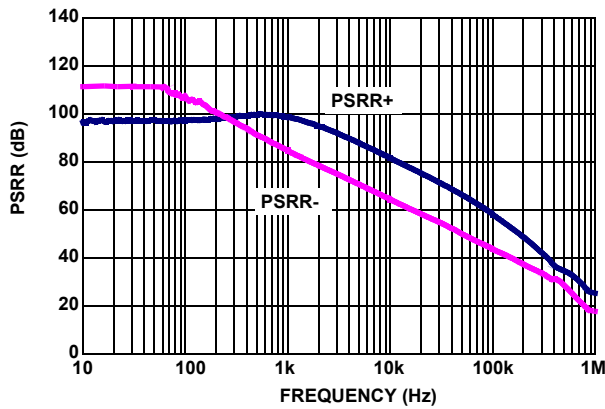

FIGURE 13. ISL28270, ISL28470 PSRR vs FREQUENCY

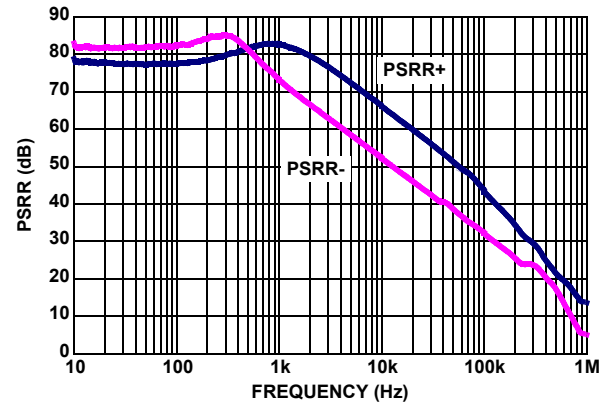

FIGURE 14. ISL28273 PSRR vs FREQUENCY

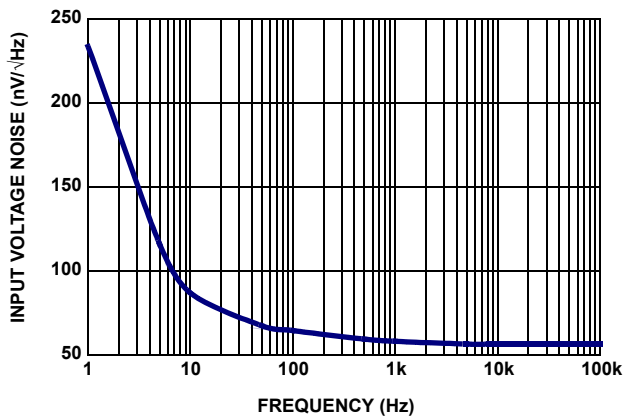

FIGURE 15. ISL28270, ISL28470 INPUT VOLTAGE NOISE SPECTRAL DENSITY (GAIN = 100)

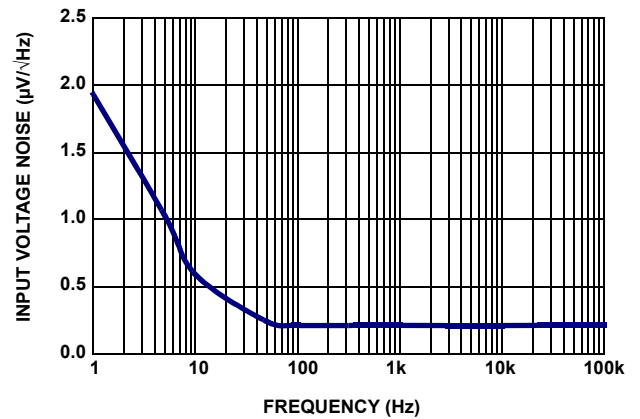

FIGURE 16. ISL28273 INPUT VOLTAGE NOISE SPECTRAL DENSITY (GAIN = 10)

Typical Performance Curves

$V_+ = +5V$, $V_- = 0V$, $V_{CM} = 1/2V_+$, $V_{EN} = V_-$, $R_L = \text{Open}$, $T_A = +25^\circ\text{C}$, unless otherwise specified. (Continued)

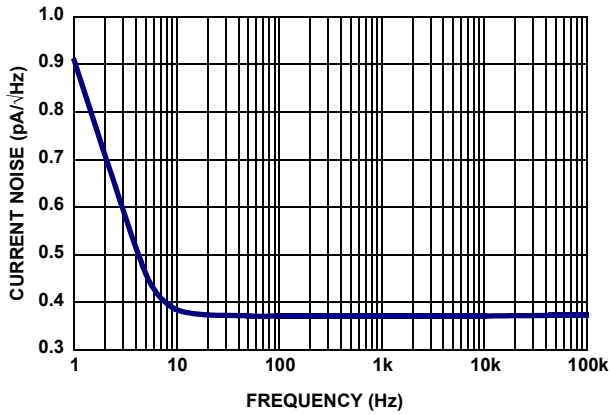

FIGURE 17. ISL28270, ISL28470 INPUT CURRENT NOISE SPECTRAL DENSITY (GAIN = 100)

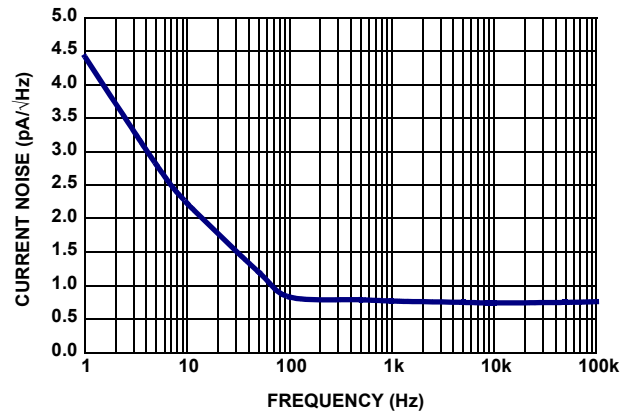

FIGURE 18. ISL28273 INPUT CURRENT NOISE SPECTRAL DENSITY (GAIN = 10)

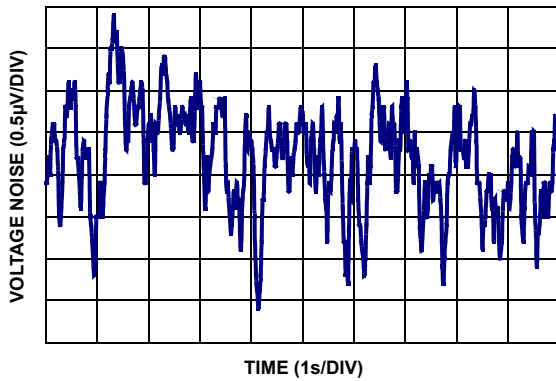

FIGURE 19. ISL28270, ISL28470 0.1Hz TO 10Hz INPUT VOLTAGE NOISE (GAIN = 100)

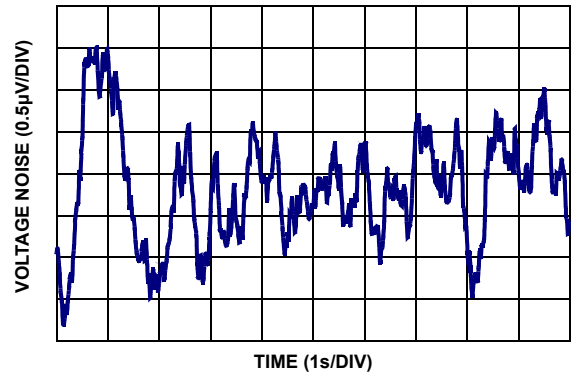

FIGURE 20. ISL28273 0.1Hz TO 10Hz INPUT VOLTAGE NOISE (GAIN = 10)

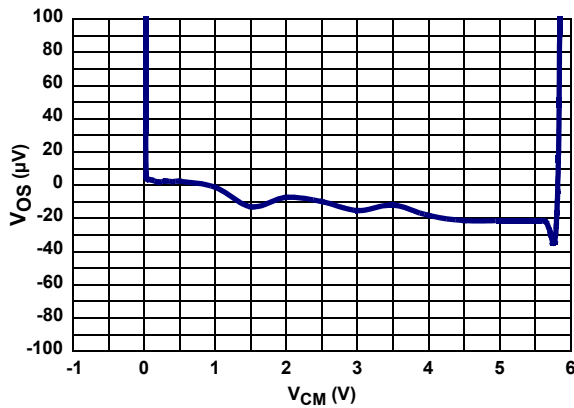

FIGURE 21. INPUT OFFSET VOLTAGE vs COMMON MODE VOLTAGE, $V_+ = 5V$

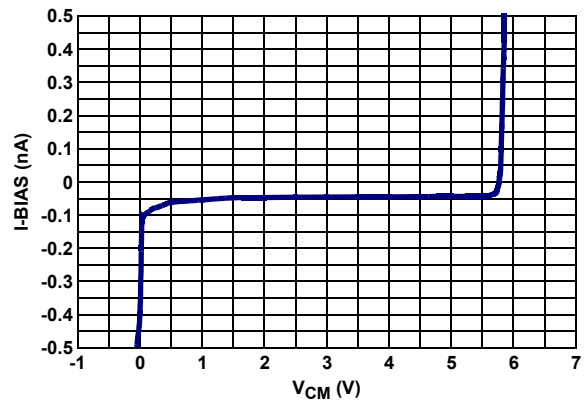

FIGURE 22. INPUT BIAS CURRENT vs COMMON MODE VOLTAGE, $V_+ = 5V$

Typical Performance Curves

$V_+ = +5V, V_- = 0V, V_{CM} = 1/2V_+, V_{EN} = V_-, R_L = \text{Open}, T_A = +25^\circ\text{C}$, unless otherwise specified. (Continued)

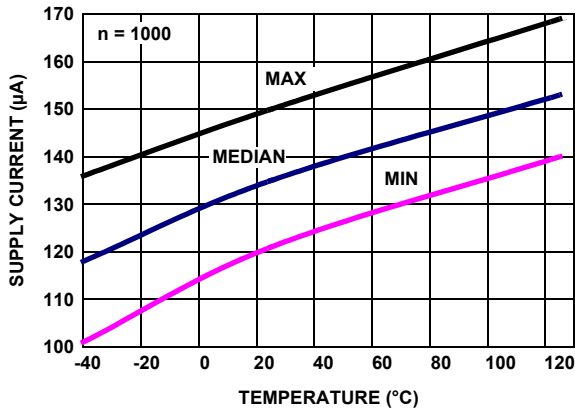

FIGURE 23. SUPPLY CURRENT (CHANNEL A AND CHANNEL B) vs TEMPERATURE, $V_+, V_- = \pm 2.5V, V_{IN} = 0V, R_L = \text{INF}$

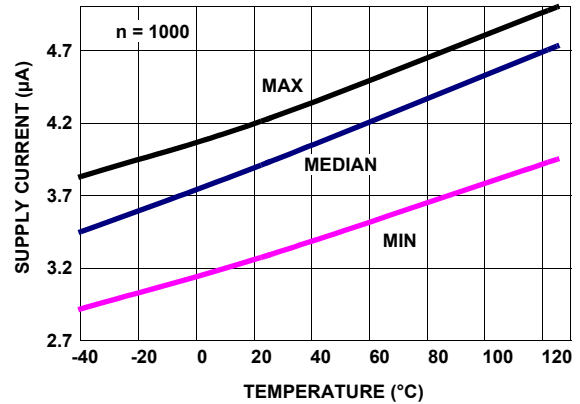

FIGURE 24. ISL28270, ISL28470 DISABLED SUPPLY CURRENT (CHANNEL A AND B) vs TEMPERATURE $V_+ = \pm 2.5V, V_{IN} = 0V, R_L = \text{INF}$

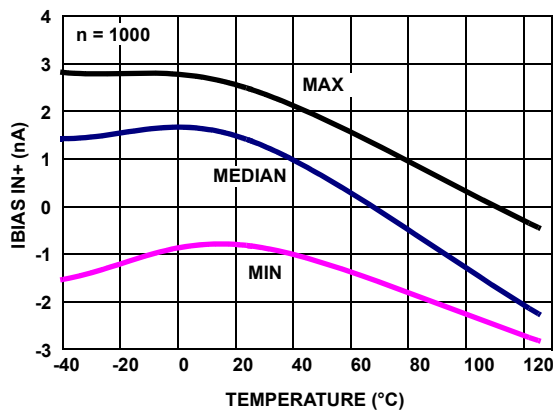

FIGURE 25. $I_{BIAS\ IN+}$ vs TEMPERATURE, $V_+, V_- = \pm 2.5V$

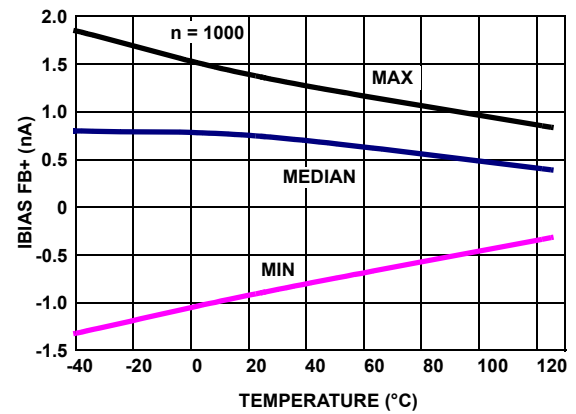

FIGURE 26. $I_{BIAS\ FB+}$ vs TEMPERATURE, $V_+, V_- = \pm 2.5V$

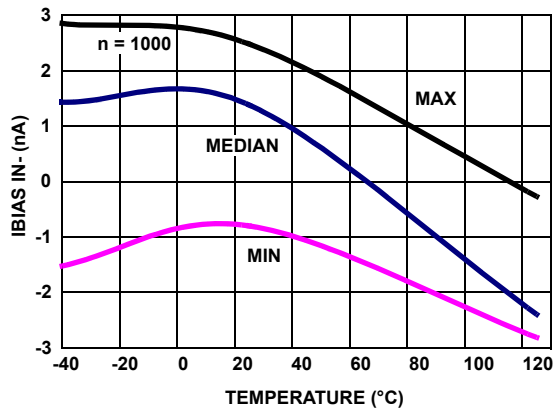

FIGURE 27. $I_{BIAS\ IN-}$ vs TEMPERATURE, $V_+, V_- = \pm 2.5V$

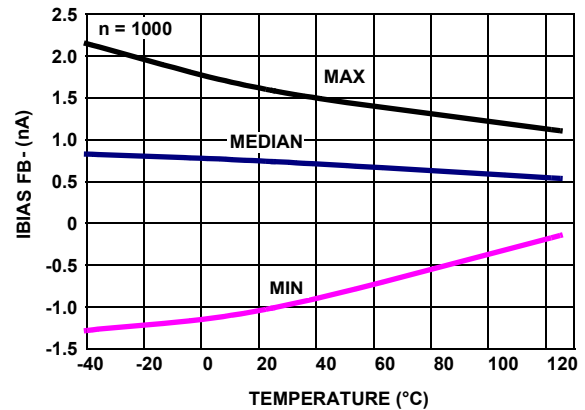

FIGURE 28. $I_{BIAS\ FB-}$ vs TEMPERATURE, $V_+, V_- = \pm 2.5V$

Typical Performance Curves

$V_+ = +5V, V_- = 0V, V_{CM} = 1/2V_+, V_{EN} = V_-, R_L = \text{Open}, T_A = +25^\circ\text{C}$,
 unless otherwise specified. (Continued)

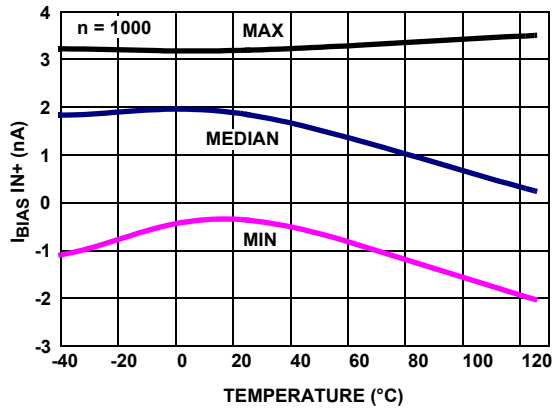

FIGURE 29. $I_{BIAS\ IN+}$ vs TEMPERATURE, $V_+, V_- = \pm 1.2V$

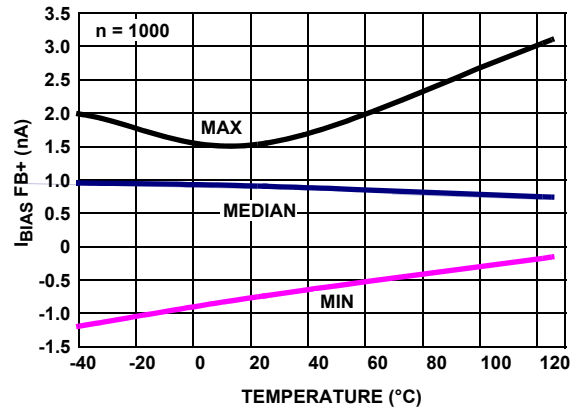

FIGURE 30. $I_{BIAS\ FB+}$ vs TEMPERATURE, $V_+, V_- = \pm 1.2V$

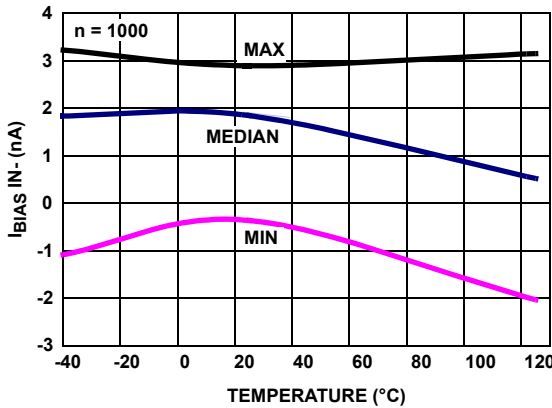

FIGURE 31. $I_{BIAS\ IN-}$ vs TEMPERATURE, $V_+, V_- = \pm 1.2V$

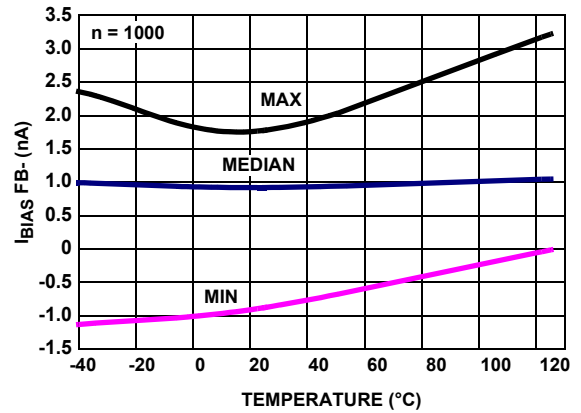

FIGURE 32. $I_{BIAS\ FB-}$ vs TEMPERATURE, $V_+, V_- = \pm 1.2V$

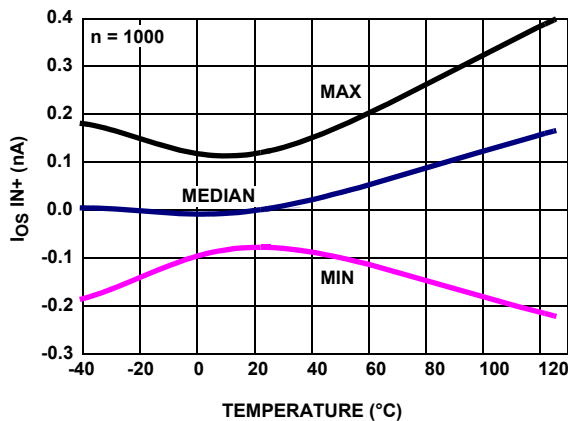

FIGURE 33. $I_{OS\ IN+}$ vs TEMPERATURE, $V_+, V_- = \pm 2.5V$

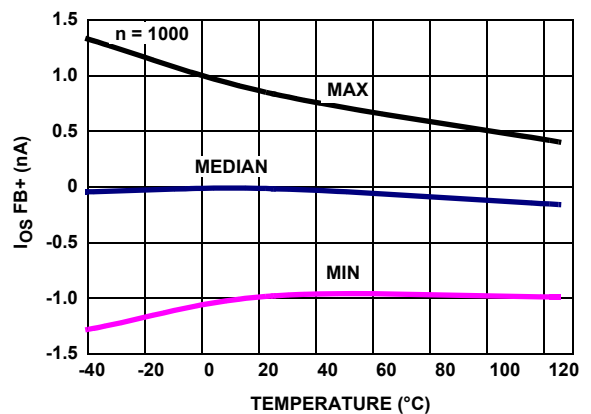

FIGURE 34. $I_{OS\ FB+}$ vs TEMPERATURE, $V_+, V_- = \pm 2.5V$

Typical Performance Curves

$V_+ = +5V, V_- = 0V, V_{CM} = 1/2V_+, V_{EN} = V_-, R_L = \text{Open}, T_A = +25^\circ\text{C}$, unless otherwise specified. (Continued)

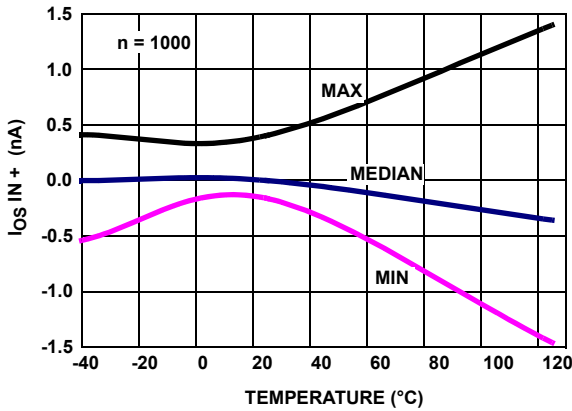

FIGURE 35. $I_{OS\ IN+}$ vs TEMPERATURE, $V_+, V_- = \pm 1.2V$

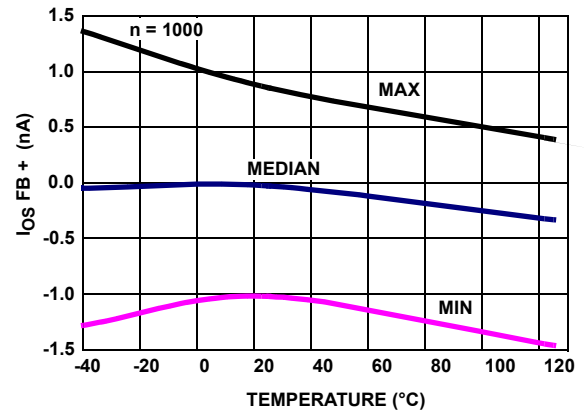

FIGURE 36. $I_{OS\ FB+}$ vs TEMPERATURE, $V_+, V_- = \pm 1.2V$

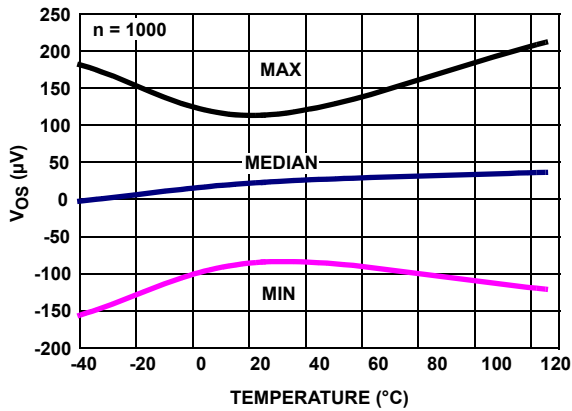

FIGURE 37. ISL28270, ISL28470 V_{OS} vs TEMPERATURE, $V_+, V_- = \pm 2.5V$

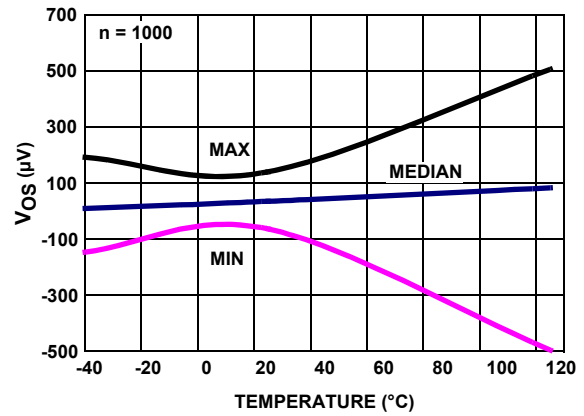

FIGURE 38. ISL28270, ISL28470 V_{OS} vs TEMPERATURE, $V_+, V_- = \pm 1.2V$

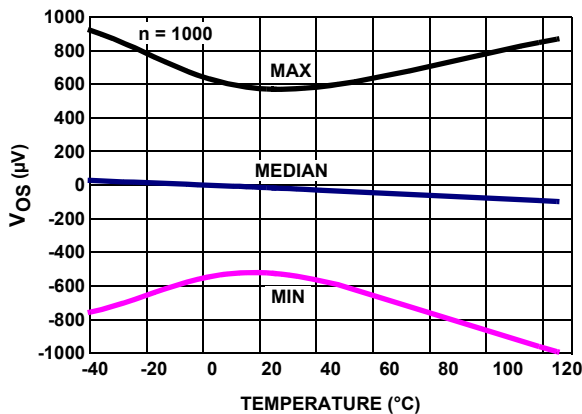

FIGURE 39. ISL28273 V_{OS} vs TEMPERATURE, $V_+, V_- = \pm 2.5V$

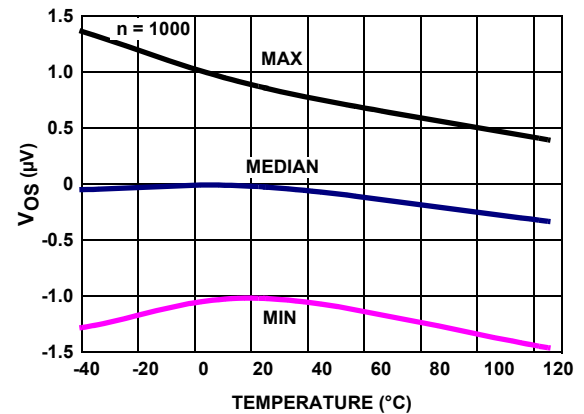

FIGURE 40. ISL28273 V_{OS} vs TEMPERATURE, $V_+, V_- = \pm 1.2V$

Typical Performance Curves

$V_+ = +5V, V_- = 0V, V_{CM} = 1/2V_+, V_{EN} = V_-, R_L = \text{Open}, T_A = +25^\circ\text{C}$, unless otherwise specified. (Continued)

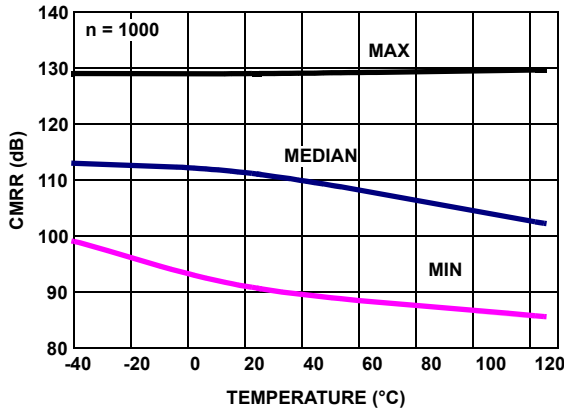

FIGURE 41. CMRR vs TEMPERATURE, $V_{CM} = +2.5V \text{ TO } -2.5V, V_+, V_- = \pm 2.5V$

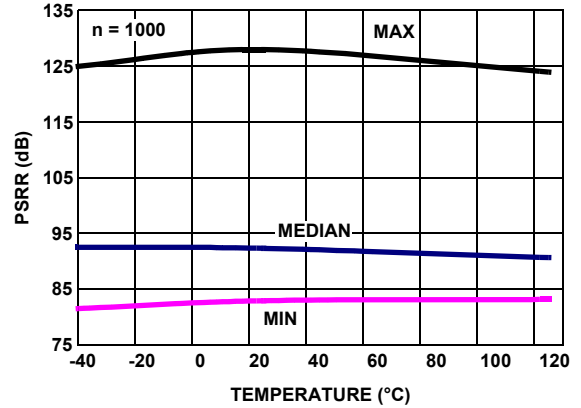

FIGURE 42. PSRR vs TEMPERATURE, $V_+, V_- = \pm 1.2V \text{ TO } \pm 2.5V$

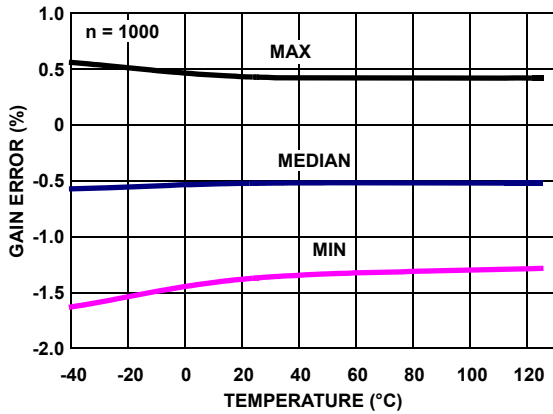

FIGURE 43. ISL28270, ISL28470 % GAIN ERROR vs TEMPERATURE, $R_L = 100k$

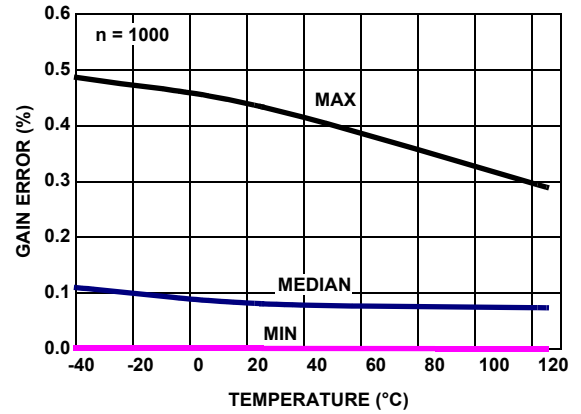

FIGURE 44. ISL28273 % GAIN ERROR vs TEMPERATURE, $R_L = 100k$

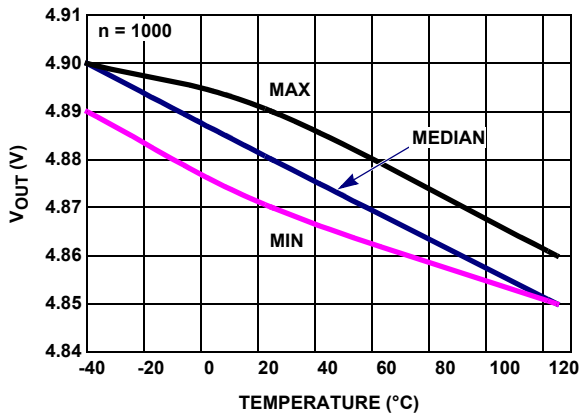

FIGURE 45. $V_{OUT \text{ HIGH}}$ vs TEMPERATURE, $R_L = 1k, V_+, V_- = \pm 2.5V$

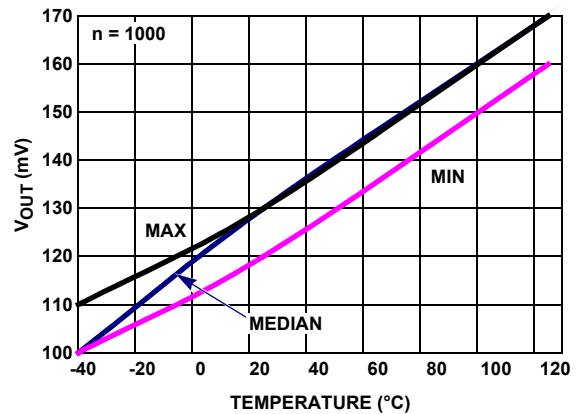

FIGURE 46. $V_{OUT \text{ LOW}}$ vs TEMPERATURE, $R_L = 1k, V_+, V_- = \pm 2.5V$

Typical Performance Curves

$V_+ = +5V$, $V_- = 0V$, $V_{CM} = 1/2V_+$, $V_{EN} = V_-$, $R_L = \text{Open}$, $T_A = +25^\circ\text{C}$, unless otherwise specified. (Continued)

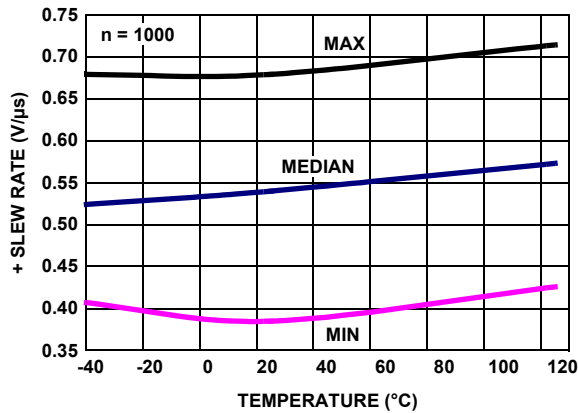

FIGURE 47. + SLEW RATE vs TEMPERATURE, INPUT = $\pm 0.015V$ AT GAIN = +10

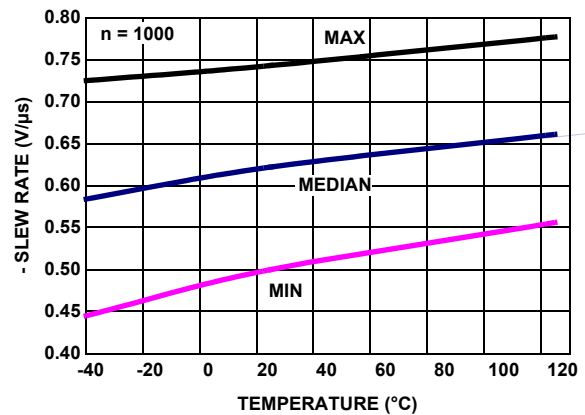

FIGURE 48. - SLEW RATE vs TEMPERATURE, INPUT = $\pm 0.15V$ AT GAIN = +10

Pin Descriptions

ISL28270 16 Ld QSOP	ISL28273 16 Ld QSOP	ISL28470 28 Ld QSOP	PIN NAME	EQUIVALENT CIRCUIT	PIN FUNCTION
2, 15	2, 15	1, 13 16, 28	OUT_A,B C,D	Circuit 3	Output Voltage. A complementary Class AB common-source output stage drives the output of each channel. When disabled, the outputs are in a high impedance state
3, 14	3, 14	2, 12 17, 27	FB+_A,B C,D	Circuit 1A, Circuit 1B	Positive Feedback high impedance terminals. ISL28270 and ISL28470 input circuit is shown in Circuit 1A, and the ISL28273 input circuit is shown in Circuit 1B. It can be used as a REF terminal to adjust or level shift the output. ISL28273: to avoid offset drift, it is recommended that the terminals of the ISL28273 are not overdriven beyond 1V and the input current must never exceed 5mA.
4, 13	4, 13	3, 11 18, 26	FB-_A,B C,D	Circuit 1A, Circuit 1B	Negative Feedback high impedance terminals. The FB- pins connect to an external resistor divider to individually set the desired gain of the in-amp. ISL28270 and ISL28470 input circuit is shown in Circuit 1A, and the ISL28273 input circuit is shown in Circuit 1B. ISL28273: to avoid offset drift, it is recommended that the terminals of the ISL28273 are not overdriven beyond 1V and the input current must never exceed 5mA.
5, 12	5, 12	4, 10 19, 25	IN-_A,B C,D	Circuit 1A, Circuit 1B	High impedance Inverting input terminals. Connect to the low side of the input source signal. ISL28270 and ISL28470 input circuit is shown in Circuit 1A, and the ISL28273 input circuit is shown in Circuit 1B. ISL28273: to avoid offset drift, it is recommended that the terminals of the ISL28273 are not overdriven beyond 1V and the input current must never exceed 5mA.
6, 11	6, 11	5, 9 20, 24	IN+_A,B C,D	Circuit 1A, Circuit 1B	High impedance Non-inverting input terminals. Connect to the high side of the input source signal. ISL28270 and ISL28470 input circuit is shown in Circuit 1A, and the ISL28273 input circuit is shown in Circuit 1B. ISL28273: to avoid offset drift, it is recommended that the terminals of the ISL28273 are not overdriven beyond 1V and the input current must never exceed 5mA.
7, 10		6, 8 21, 23	$\overline{\text{EN}}_{A,B}$ C,D	Circuit 2	Active LOW logic pins. When pulled above 2V, the corresponding channel turns off and OUT is high impedance. A channel is enabled when pulled below 0.8V. Built-in pull downs define each $\overline{\text{EN}}$ pin LOW when left floating.

Pin Descriptions (Continued)

ISL28270 16 Ld QSOP	ISL28273 16 Ld QSOP	ISL28470 28 Ld QSOP	PIN NAME	EQUIVALENT CIRCUIT	PIN FUNCTION
16	16	7	V ₊	Circuit 4	Positive Supply terminal shared by all channels.
8	8	22	V ₋	Circuit 4	Negative Supply terminal shared by all channels. Grounded for single supply operation.
1, 9	1, 9	14, 15	NC		No Connect, pins can be left floating or grounded.
	7, 10		DNC		Do Not Connect: Internal connection- Must be left floating.

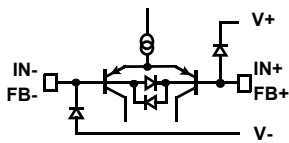

CIRCUIT 1A

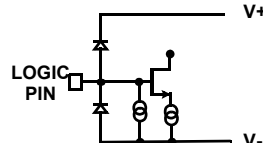

CIRCUIT 2

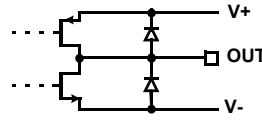

CIRCUIT 3

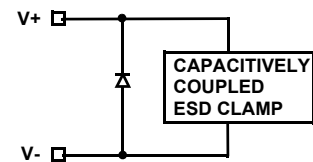

CIRCUIT 4

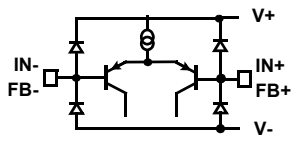

CIRCUIT 1B

Application Information**Product Description**

The ISL28270 and ISL28273 are dual channel micro-power instrumentation amplifiers (in-amps) and the ISL28470 is a quad channel which deliver rail-to-rail input amplification and rail-to-rail output swing. The in-amps also deliver excellent DC and AC specifications while consuming only about 60 μ A per channel. Because the independent pair of feedback terminals set the gain and adjust the output zero level, the ISL28270, ISL28273 and ISL28470 achieve high CMRR regardless of the tolerance of the gain setting resistors. The ISL28270 and ISL28470 are internally compensated for a minimum gain of 100. The ISL28273 is internally compensated for a minimum gain of 10.

Input Protection

All input terminals and feedback terminals have internal ESD protection diodes to both positive and negative supply rails, limiting the input voltage to within one diode beyond the supply rails. Input signals originating from low impedance sources should have current limiting resistors in series with the IN₊ and IN₋ pins to prevent damaging currents during power supply sequencing and other transient conditions. The ISL28270 and ISL28470 have additional back-to-back diodes across the input terminals and also across the feedback terminals. If overdriving the inputs is necessary, the external input current must never exceed 5mA. External series resistors may be used as an external protection to limit excessive external voltage and current from damaging the inputs. On the other

hand, the ISL28273 has no clamps to limit the differential voltage on the input terminals allowing higher differential input voltages at lower gain applications. It is recommended, however, that the terminals of the ISL28273 are not overdriven beyond 1V to avoid offset drift.

Input Stage and Input Voltage Range

The input terminals (IN₊ and IN₋) of the in-amps are a single differential pair of bipolar PNP devices aided by an Input Range Enhancement Circuit (IREC), to increase the headroom of operation of the common-mode input voltage. The feedback terminals (FB₊ and FB₋) also have a similar topology. As a result, the input common-mode voltage range is rail-to-rail regardless of the feedback terminal settings and regardless of the gain settings. They are able to handle input voltages that are at or slightly beyond the supply and close to ground making these in-amps well suited for single 5V down to 2.4V supply systems. There is no need to bias the common-mode input to achieve symmetrical input voltage. It is recommended however that the common-mode input be biased at least 10mV above the negative supply rail to achieve top performance. See "Input Bias Cancellation/Compensation" on page 15.

The IREC enables rail-to-rail input amplification without the problems usually associated with the dual differential stage topology. The IREC ensures that there are no drastic changes in offset voltage over the entire range of the input. See Input Offset Voltage vs Common-Mode Input Voltage on page 8. IREC also cures the abrupt change and even reverse polarity

of the input bias current over the whole range of input. See Input Bias Current vs Common-Mode Input Voltage on page 8.

Input Bias Cancellation/Compensation

All three parts have an Input Bias Cancellation/Compensation Circuit for both the input and feedback terminals (IN+, IN-, FB+ and FB-), achieving a low input bias current throughout the input common-mode range and the operating temperature range. While the PNP bipolar input stages are biased with an adequate amount of biasing current for speed and increased noise performance, the Input Bias Cancellation/Compensation Circuit sinks most of the base current of the input transistors leaving a small portion as input bias current, typically 500pA. In addition, the Input Bias Cancellation/Compensation Circuit maintains a smooth and flat behavior of input bias current over the common mode range and over the operating temperature range. The Input Bias Cancellation/Compensation Circuit operates from input voltages of 10mV above the negative supply to input voltages slightly above the positive supply. See Input Bias Current vs Common-Mode Input Voltage in the “Typical Performance Curves” on page 8.

Output Stage and Output Voltage Range

A Class AB common-source output stage drives the output. The pair of complementary MOSFET devices drive the output VOUT to within a few millivolts of the supply rails. At a 100kΩ load, the PMOS sources current and pulls the output up to 4mV below the positive supply. The NMOS sinks current and pulls the output down to 4mV above the negative supply, or ground in the case of a single supply operation. The current sinking and sourcing capability are internally limited to 29mA. When disabled, the outputs are in a high impedance state.

Gain Setting

VIN, the potential difference across IN+ and IN-, is replicated (less the input offset voltage) across FB+ and FB-. The function of the in-amp is to maintain the differential voltage across FB- and FB+ equal to IN+ and IN-; (FB- - FB+) = (IN+ - IN-). Consequently, the transfer function can be derived. The in-amp gain is set by two external resistors, the feedback resistor R_F, and the gain resistor R_G

$$V_{IN} = IN+ - IN-$$

$$V_{OUT} = \left(1 + \frac{R_F}{R_G}\right) V_{IN} \quad (\text{EQ. 1})$$

In Figure 49, the FB+ pin and one end of resistor R_G are connected to GND. With this configuration, Equation 1 is only true for a positive swing in VIN; negative input swings will be ignored because the output will be at ground.

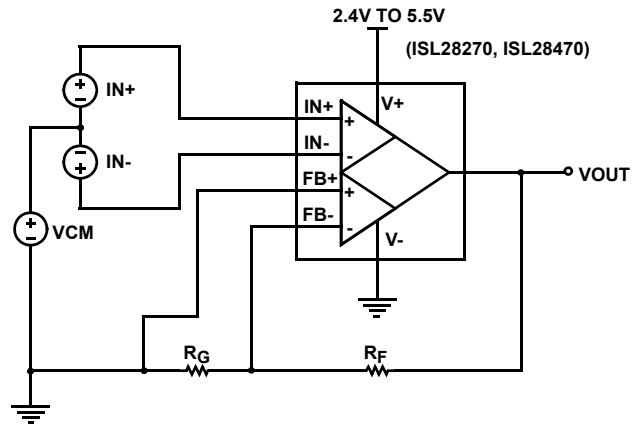

FIGURE 49. GAIN IS SET BY TWO EXTERNAL RESISTORS, R_F AND R_G

Reference Connection

Unlike a 3 op amp in-amp realization, a finite series resistance seen at the REF terminal does not degrade the high CMRR performance, eliminating the need for an additional external buffer amplifier. Figure 50 uses the FB+ pin to provide a high impedance REF terminal.

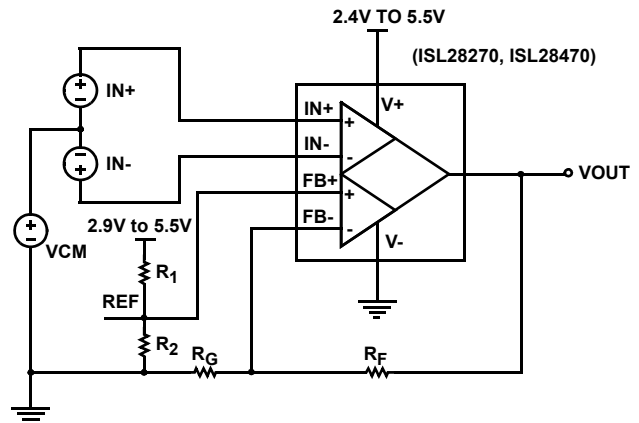

FIGURE 50. GAIN SETTING AND REFERENCE CONNECTION

$$V_{IN} = IN+ - IN-$$

$$V_{OUT} = \left(1 + \frac{R_F}{R_G}\right) (V_{IN}) + \left(1 + \frac{R_F}{R_G}\right) (V_{REF}) \quad (\text{EQ. 2})$$

The FB+ pin is used as a REF terminal to center or to adjust the output. Because the FB+ pin is a high impedance input, an economical resistor divider can be used to set the voltage at the REF terminal without degrading or affecting the CMRR performance. Any voltage applied to the REF terminal will shift VOUT by VREF times the closed loop gain, which is set by resistors R_F and R_G. Note that any noise or unwanted signals on the reference supply will be amplified at the output according to Equation 2. See Figure 50.

The FB+ pin can also be connected to the other end of resistor, R_G. See Figure 51. Keeping the basic concept that the in-amp

maintains constant differential voltage across the input terminals and feedback terminals (FB- - FB+) = (IN+ - IN-), the transfer function of Figure 51 can be derived from Equation 3. Note that the VREF gain term is eliminated, and susceptibility to external noise is reduced.

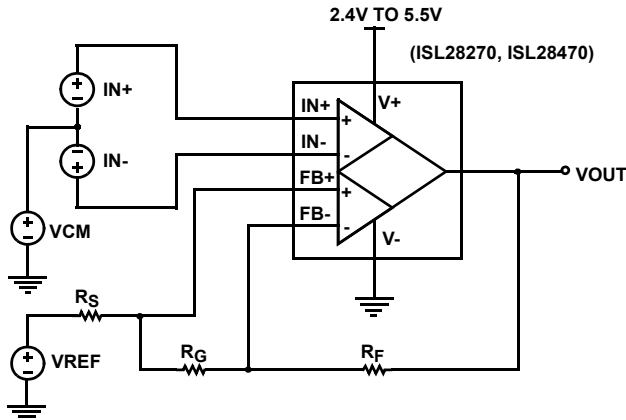

FIGURE 51. REFERENCE CONNECTION WITH AN AVAILABLE VREF

$$VIN = IN+ - IN-$$

$$VOUT = \left[1 + \frac{R_S + R_F}{R_G} \right] + VREF \quad (EQ. 3)$$

$$VOUT = \left(1 + \frac{R_F}{R_G} \right) (VIN) + (VREF) \quad (EQ. 4)$$

A finite resistance R_S in series with the VREF source, adds an output offset of $VIN \cdot (R_S/R_G)$. As the series resistance R_S approaches zero, Equation 3 is simplified to Equation 4 for Figure 51. VOUT is simply shifted by an amount VREF.

External Resistor Mismatches

Because of the independent pair of feedback terminals provided by the in-amps, the CMRR is not degraded by any resistor mismatches. Hence, unlike a three op amp and especially a two op amp in-amp realization, the ISL28270, ISL28273 and ISL28470 reduce the cost of external components by allowing the use of 1% or more tolerance resistors without sacrificing CMRR performance. The CMRR will be typically 110dB regardless of the tolerance of the resistors used. Instead, a resistor mismatch results in a higher deviation from the theoretical gain - gain error.

Gain Error and Accuracy

The gain error indicated in the “Electrical Specifications” table on page 4 is the inherent gain error alone. The gain error specification listed does not include the gain error contributed by the resistors. There is an additional gain error due to the tolerance of the resistors used. The resulting non-ideal transfer function effectively becomes: (see Equation 5)

$$VOUT = \left(1 + \frac{R_F}{R_G} \right) \times [1 \pm (E_{RG} + E_{RF} + E_G)] \times VIN \quad (EQ. 5)$$

Where:

E_{RG} = Tolerance of R_G

E_{RF} = Tolerance of R_F

E_G = Gain Error of the ISL28270

The term $[1 - (E_{RG} + E_{RF} + E_G)]$ is the deviation from the theoretical gain. Thus, $(E_{RG} + E_{RF} + E_G)$ is the total gain error. For example, if 1% resistors are used, the total gain error would be shown in Equation 6.

$$\text{TotalGainError} = \pm(E_{RG} + E_{RF} + E_G(\text{typical})) \quad (EQ. 6)$$

$$\text{TotalGainError} = \pm(0.01 + 0.01 + 0.005) = \pm 2.5\%$$

Disable/Power-Down

The ISL28270 and ISL28470 have an enable/disable pin for each channel. They can be powered down to reduce the supply current to typically 4µA when all channels are off. When disabled, the corresponding output is in a high impedance state. The active low \overline{EN} pin has an internal pull down and hence can be left floating and the in-amp enabled by default. When the \overline{EN} is connected to an external logic, the in-amp will shutdown when \overline{EN} pin is pulled above 2V, and will power up when \overline{EN} bar is pulled below 0.8V.

Unused Channels

The ISL28270, ISL28273 and ISL28470 are dual and quad channel op amps. If the application only requires one channel when using the ISL28270, ISL28273 or less than 4 channels when using the ISL28470, the user must configure the unused channel(s) to prevent them from oscillating. The unused channel(s) will oscillate if the input and output pins are floating. This will result in higher than expected supply currents and possible noise injection into the channel being used. The proper way to prevent this oscillation is to short the IN+ and IN- terminals to ground and short the FB+, FB- and the output terminals to ground as shown in Figure 52.

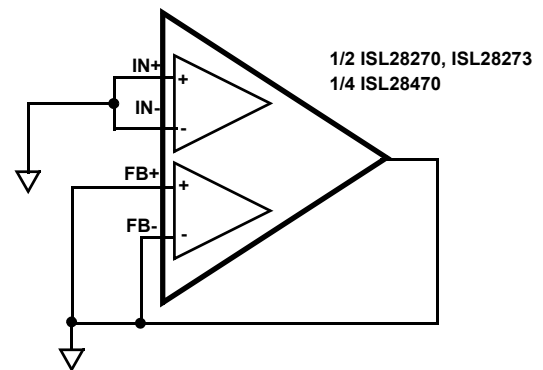

FIGURE 52. PREVENTING OSCILLATIONS IN UNUSED CHANNELS

Power Dissipation

It is possible to exceed the +150°C maximum junction temperatures under certain load and power-supply conditions. It is therefore important to calculate the maximum junction temperature (T_{JMAX}) for all applications to determine if power supply voltages, load conditions, or package type need to be modified to remain in the safe operating area. These parameters are related in Equation 7:

$$T_{JMAX} = T_{MAX} + (\theta_{JA} \times PD_{MAXTOTAL}) \quad (\text{EQ. 7})$$

where:

- $PD_{MAXTOTAL}$ is the sum of the maximum power dissipation of each amplifier in the package (PD_{MAX})
- PD_{MAX} for each amplifier can be calculated as shown in Equation 8:

$$PD_{MAX} = 2 \times V_S \times I_{SMAX} + (V_S - V_{OUTMAX}) \times \frac{V_{OUTMAX}}{R_L} \quad (\text{EQ. 8})$$

where:

- T_{MAX} = Maximum ambient temperature
- θ_{JA} = Thermal resistance of the package
- PD_{MAX} = Maximum power dissipation of 1 amplifier
- V_S = Supply voltage (Magnitude of V_+ and V_-)
- I_{MAX} = Maximum supply current of 1 amplifier
- V_{OUTMAX} = Maximum output voltage swing of the application
- R_L = Load resistance

Quarter Size Outline Plastic Packages Family (QSOP)



MDP0040

QUARTER SIZE OUTLINE PLASTIC PACKAGES FAMILY

SYMBOL	INCHES			TOLERANCE	NOTES
	QSOP16	QSOP24	QSOP28		
A	0.068	0.068	0.068	Max.	-
A1	0.006	0.006	0.006	± 0.002	-
A2	0.056	0.056	0.056	± 0.004	-
b	0.010	0.010	0.010	± 0.002	-
c	0.008	0.008	0.008	± 0.001	-
D	0.193	0.341	0.390	± 0.004	1, 3
E	0.236	0.236	0.236	± 0.008	-
E1	0.154	0.154	0.154	± 0.004	2, 3
e	0.025	0.025	0.025	Basic	-
L	0.025	0.025	0.025	± 0.009	-
L1	0.041	0.041	0.041	Basic	-
N	16	24	28	Reference	-

Rev. F 2/07

NOTES:

1. Plastic or metal protrusions of 0.006" maximum per side are not included.
2. Plastic interlead protrusions of 0.010" maximum per side are not included.
3. Dimensions "D" and "E1" are measured at Datum Plane "H".
4. Dimensioning and tolerancing per ASME Y14.5M-1994.

© Copyright Intersil Americas LLC 2006-2009. All Rights Reserved.
 All trademarks and registered trademarks are the property of their respective owners.

For additional products, see www.intersil.com/en/products.html

Intersil products are manufactured, assembled and tested utilizing ISO9001 quality systems as noted in the quality certifications found at www.intersil.com/en/support/qualandreliability.html

Intersil products are sold by description only. Intersil may modify the circuit design and/or specifications of products at any time without notice, provided that such modification does not, in Intersil's sole judgment, affect the form, fit or function of the product. Accordingly, the reader is cautioned to verify that datasheets are current before placing orders. Information furnished by Intersil is believed to be accurate and reliable. However, no responsibility is assumed by Intersil or its subsidiaries for its use; nor for any infringements of patents or other rights of third parties which may result from its use. No license is granted by implication or otherwise under any patent or patent rights of Intersil or its subsidiaries.

For information regarding Intersil Corporation and its products, see www.intersil.com