

ISL28113, ISL28213, ISL28413

Single, Dual, Quad General Purpose Micropower, RRIO Operational Amplifier

FN6728
Rev 8.00
April 8, 2015

The ISL28113, ISL28213 and ISL28413 are single, dual and quad channel general purpose micropower, rail-to-rail input and output operational amplifiers with supply voltage range of 1.8V to 5.5V. Key features are a low supply current of 130µA maximum per channel at room temperature, a low bias current and a wide input voltage range, which enables the ISL28x13 devices to be excellent general purpose operational amplifiers for a wide range of applications.

The ISL28113 is available in the SC70-5 and SOT23-5 packages, the ISL28213 is in the MSOP8, SOIC8, SOT23-8 packages and the ISL28413 is in the TSSOP14, SOIC14 packages. All devices operate across the extended temperature range of -40°C to +125°C.

Related Literature

- See [AN1519](#) for “ISL28213/14SOICEVAL2Z Evaluation Board User’s Guide”
- See [AN1520](#) for “ISL28113/14SOT23EVAL1Z Evaluation Board User’s Guide”
- See [AN1542](#) for “ISL28213/14MSOPEVAL2Z Evaluation Board User’s Guide”

Features

- Low current consumption 130µA
- Wide supply range 1.8V to 5.5V
- Gain bandwidth product 2MHz
- Input bias current. 20pA, Max.
- Operating temperature range. -40°C to +125°C
- Packages
 - ISL28113 (Single) SC70-5, SOT23-5
 - ISL28213 (Dual). MSOP8, SOIC8, SOT23-8
 - ISL28413 (Quad) SOIC14, TSSOP14

Applications

- Power supply control/regulation
- Process control
- Signal gain/buffers
- Active filters
- Current shunt sensing
- Transimpedance amps

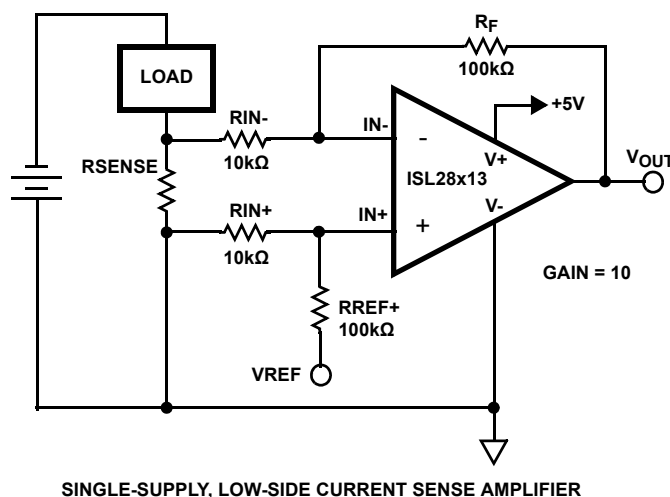

FIGURE 1. TYPICAL APPLICATION

Ordering Information

PART NUMBER (Note 4)	PART MARKING	PACKAGE (RoHS Compliant)	PKG. DWG. #
ISL28113FEZ-T7 (Notes 1, 2)	BJA (Note 5)	5 Ld SC-70	P5.049
ISL28113FEZ-T7A (Notes 1, 2)	BJA (Note 5)	5 Ld SC-70	P5.049
ISL28113FHZ-T7 (Notes 1, 2)	BCYA (Note 5)	5 Ld SOT-23	P5.064A
ISL28113FHZ-T7A (Notes 1, 2)	BCYA (Note 5)	5 Ld SOT-23	P5.064A
ISL28213FUZ (Note 2)	8213Z	8 Ld MSOP	M8.118A
ISL28213FUZ-T7 (Notes 1, 2)	8213Z	8 Ld MSOP	M8.118A
ISL28213FBZ (Note 2)	28213 FBZ	8 Ld SOIC	M8.15E
ISL28213FBZ-T7 (Notes 1, 2)	28213 FBZ	8 Ld SOIC	M8.15E
ISL28213FBZ-T13 (Notes 1, 2)	28213 FBZ	8 Ld SOIC	M8.15E
ISL28213FHZ-T7 (Notes 1, 3)	BEKA (Note 5)	8 Ld SOT-23	P8.064
ISL28213FHZ-T7A (Notes 1, 3)	BEKA (Note 5)	8 Ld SOT-23	P8.064
ISL28413FVZ (Note 2)	28413 FVZ	14 Ld TSSOP	MDP0044
ISL28413FVZ-T7 (Notes 1, 2)	28413 FVZ	14 Ld TSSOP	MDP0044
ISL28413FVZ-T13 (Notes 1, 2)	28413 FVZ	14 Ld TSSOP	MDP0044
ISL28413FBZ (Note 2)	28413 FBZ	14 Ld SOIC	MDP0027
ISL28413FBZ-T7 (Notes 1, 2)	28413 FBZ	14 Ld SOIC	MDP0027
ISL28413FBZ-T13 (Notes 1, 2)	28413 FBZ	14 Ld SOIC	MDP0027
ISL28113SOT23EVAL1Z	Evaluation Board		
ISL28213MSOPEVAL2Z	Evaluation Board		
ISL28213SOICEVAL2Z	Evaluation Board		

NOTES:

1. Please refer to [TB347](#) for details on reel specifications.
2. These Intersil Pb-free plastic packaged products employ special Pb-free material sets, molding compounds/die attach materials, and 100% matte tin plate plus anneal (e3 termination finish, which is RoHS compliant and compatible with both SnPb and Pb-free soldering operations). Intersil Pb-free products are MSL classified at Pb-free peak reflow temperatures that meet or exceed the Pb-free requirements of IPC/JEDEC J STD-020.
3. These Intersil Pb-free plastic packaged products employ special Pb-free material sets; molding compounds/die attach materials and NiPdAu plate - e4 termination finish, which is RoHS compliant and compatible with both SnPb and Pb-free soldering operations. Intersil Pb-free products are MSL classified at Pb-free peak reflow temperatures that meet or exceed the Pb-free requirements of IPC/JEDEC J STD-020.
4. For Moisture Sensitivity Level (MSL), please see device information page for [ISL28113](#), [ISL28213](#), [ISL28413](#). For more information on MSL please see Techbrief [TB363](#).
5. The part marking is located on the bottom of the part.

Pin Configurations

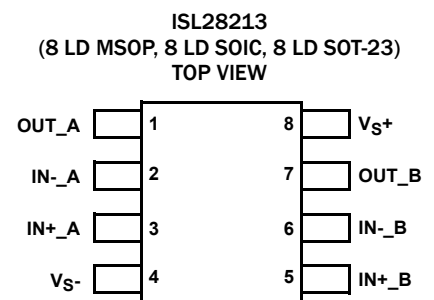
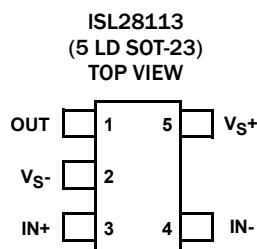
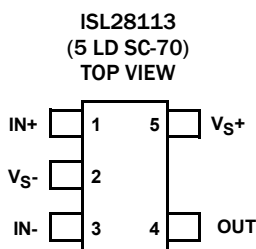

Pin Configurations (Continued)

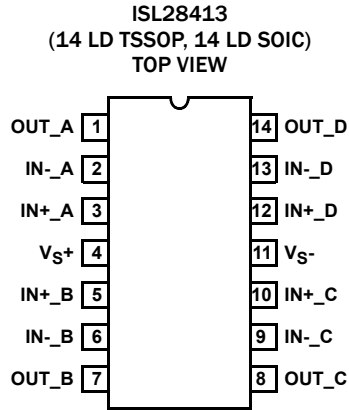

Pin Descriptions

PIN NAME	PIN NUMBER				DESCRIPTION	
	5 LD SC-70	5 LD SOT-23	8 LD MSOP, 8 LD SOIC, 8 LD SOT-23	14 LD TSSOP, 14 LD SOIC		
OUT	4	1			Output	<p style="text-align: center;">CIRCUIT 1</p>
OUT_A			1	1		
OUT_B			7	7		
OUT_C				8		
OUT_D				14		
VS-	2	2	4	11	Negative supply voltage	<p style="text-align: center;">CIRCUIT 2</p>
IN+	1	3			Positive Input	<p style="text-align: center;">CIRCUIT 3</p>
IN+_A			3	3		
IN+_B			5	5		
IN+_C				10		
IN+_D				12		
IN-	3	4			Negative Input	
IN_A			2	2		
IN_B			6	6		
IN_C				9		
IN_D				13		
VS+	5	5	8	4	Positive supply voltage	See "CIRCUIT 2"

Absolute Maximum Ratings ($T_A = +25^\circ\text{C}$)

Supply Voltage	6.5V
Supply Turn-on Voltage Slew Rate	1V/ μs
Differential Input Current	20mA
Differential Input Voltage	$V_- - 0.5\text{V}$ to $V_+ + 0.5\text{V}$
Input Voltage	$V_- - 0.5\text{V}$ to $V_+ + 0.5\text{V}$
ESD Rating	
Human Body Model	4000V
Machine Model	
ISL28113, ISL28213	350V
ISL28413	400V
Charged Device Model	2000V

Thermal Information

Thermal Resistance (Typical)	θ_{JA} ($^\circ\text{C}/\text{W}$)	θ_{JC} ($^\circ\text{C}/\text{W}$)
5 Ld SC-70 (Notes 6, 7)	250	N/A
5 Ld SOT-23 (Notes 6, 7)	225	N/A
8 Ld MSOP (Notes 6, 7)	180	100
8 Ld SOIC Package (Notes 6, 7)	126	90
8 Ld SOT-23 (Notes 6, 7)	240	168
14 Ld TSSOP Package (Notes 6, 7)	120	40
14 Ld SOIC Package (Notes 6, 7)	90	50
Ambient Operating Temperature Range	-40 $^\circ\text{C}$ to +125 $^\circ\text{C}$	
Storage Temperature Range	-65 $^\circ\text{C}$ to +150 $^\circ\text{C}$	
Operating Junction Temperature	+125 $^\circ\text{C}$	
Pb-free Reflow Profile	see TB493	

CAUTION: Do not operate at or near the maximum ratings listed for extended periods of time. Exposure to such conditions may adversely impact product reliability and result in failures not covered by warranty.

NOTES:

- θ_{JA} is measured with the component mounted on a high effective thermal conductivity test board in free air. See Tech Brief [TB379](#) for details.
- For θ_{JC} , the "case temp" location is the top of the package.

Electrical Specifications $V_{S+} = 5\text{V}$, $V_{S-} = 0\text{V}$, $R_L = \text{Open}$, $V_{CM} = V_S/2$, $T_A = +25^\circ\text{C}$, unless otherwise specified. **Boldface limits apply across the operating temperature range, -40 $^\circ\text{C}$ to +125 $^\circ\text{C}$** , unless otherwise specified.

PARAMETER	DESCRIPTION	TEST CONDITIONS	MIN (Note 8)	TYP	MAX (Note 8)	UNIT
DC SPECIFICATIONS						
V_{OS}	Input Offset Voltage		-4	0.5	4	mV
			-5		5	mV
TCV_{OS}	Input Offset Voltage Temperature Coefficient	-40 $^\circ\text{C}$ to +125 $^\circ\text{C}$		5		$\mu\text{V}/^\circ\text{C}$
I_{OS}	Input Offset Current			1	30	μA
I_B	Input Bias Current	ISL28113	-20	3	20	μA
			-100		100	μA
		ISL28213, ISL28413	-20	3	20	μA
			-50		50	μA
Common Mode Input Voltage Range			-0.1V		+5.1V	V
Z_{IN}	Input Impedance			10 ¹²		Ω
C_{IN}	Input Capacitance			1		pF
CMRR	Common Mode Rejection Ratio	$V_{CM} = -0.1\text{V}$ to 5.1V		72		dB
		-40 $^\circ\text{C}$ to +125 $^\circ\text{C}$		70		dB
PSRR	Power Supply Rejection Ratio	$V_S = 1.8\text{V}$ to 5.5V		71		dB
		-40 $^\circ\text{C}$ to +125 $^\circ\text{C}$		70		dB
V_{OH}	Output Voltage Swing, High	$R_L = 10\text{k}\Omega$	4.985	4.993		V
			4.98			V
V_{OL}	Output Voltage Swing, Low	$R_L = 10\text{k}\Omega$		13	15	mV
					20	mV
V_+	Supply Voltage		1.8		5.5	V
I_S	Supply Current per Amplifier	$R_L = \text{OPEN}$		90	130	μA
					170	μA

Electrical Specifications $V_{S+} = 5V$, $V_{S-} = 0V$, $R_L = \text{Open}$, $V_{CM} = V_S/2$, $T_A = +25^\circ\text{C}$, unless otherwise specified. **Boldface limits apply across the operating temperature range, -40°C to $+125^\circ\text{C}$** , unless otherwise specified. (Continued)

PARAMETER	DESCRIPTION	TEST CONDITIONS	MIN (Note 8)	TYP	MAX (Note 8)	UNIT
I_{SC+}	Output Source Short Circuit Current	$R_L = 10\Omega$ to V-		-22		mA
I_{SC-}	Output Sink Short Circuit Current	$R_L = 10\Omega$ to V+		16		mA
AC SPECIFICATIONS						
GBWP	Gain Bandwidth Product	$V_S = \pm 2.5V$ $A_V = 100$, $R_F = 100k\Omega$, $R_G = 1k\Omega$, $R_L = 10k\Omega$ to V_{CM}		2		MHz
e_N V _{P-P}	Peak-to-Peak Input Noise Voltage	$V_S = \pm 2.5V$ $f = 0.1\text{Hz}$ to 10Hz		14		μV_{P-P}
e_N	Input Noise Voltage Density	$V_S = \pm 2.5V$ $f = 1\text{kHz}$		55		$\text{nV}/\sqrt{\text{Hz}}$
		$V_S = \pm 2.5V$ $f = 10\text{kHz}$		29		$\text{nV}/\sqrt{\text{Hz}}$
i_N	Input Noise Current Density	$V_S = \pm 2.5V$ $f = 1\text{kHz}$		5		$\text{fA}/\sqrt{\text{Hz}}$
C_{in}	Differential Input Capacitance	$V_S = \pm 2.5V$ $f = 1\text{MHz}$		1.0		pF
	Common Mode Input Capacitance			1.3		pF
TRANSIENT RESPONSE						
SR	Slew Rate 20% to 80% V_{OUT}	$V_{OUT} = 0.5V$ to $4.5V$		1		$\text{V}/\mu\text{s}$
t_r , t_f , Small Signal	Rise Time, t_r 10% to 90%	$V_S = \pm 2.5V$ $A_V = +1$, $V_{OUT} = 0.05V_{P-P}$, $R_F = 0\Omega$, $R_L = 10k\Omega$, $C_L = 15\text{pF}$		100		ns
	Fall Time, t_f 10% to 90%			115		ns
t_s	Settling Time to 0.1%, $4V_{P-P}$ Step	$V_S = \pm 2.5V$ $A_V = +1$, $R_F = 0\Omega$, $R_L = 10k\Omega$, $C_L = 1.2\text{pF}$		7.5		μs

NOTE:

8. Compliance to datasheet limits is assured by one or more methods: production test, characterization and/or design.

Typical Performance Curves $V_S = \pm 2.5V, V_{CM} = 0V, R_L = \text{Open}$, unless otherwise specified.

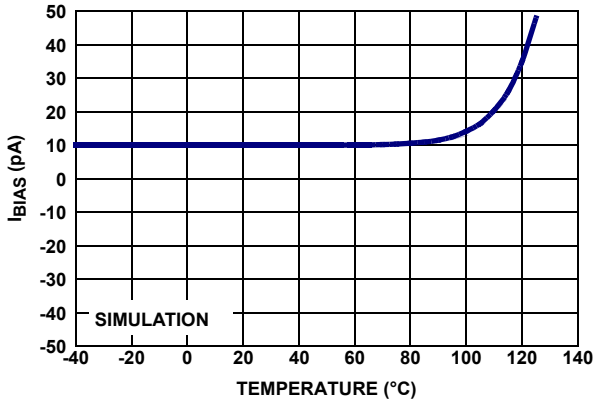

FIGURE 2. INPUT BIAS CURRENT vs TEMPERATURE

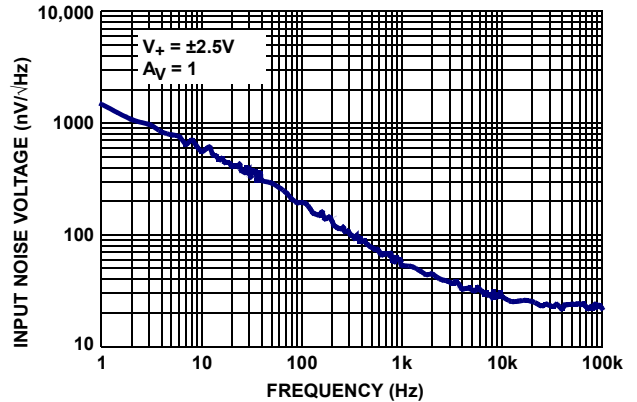

FIGURE 3. INPUT NOISE VOLTAGE SPECTRAL DENSITY

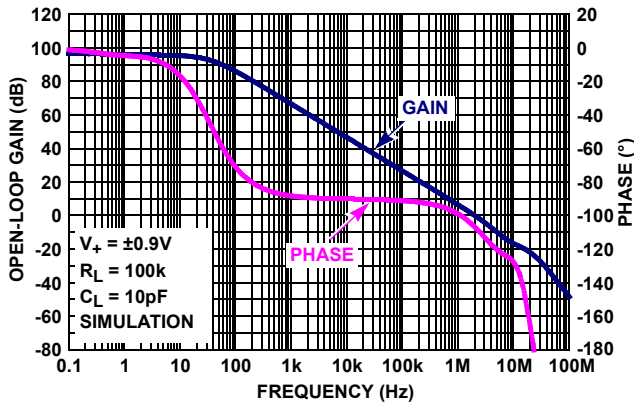

FIGURE 4. OPEN-LOOP GAIN, PHASE vs FREQUENCY, $R_L = 100k\Omega$, $C_L = 10pF$, $V_S = \pm 0.9V$

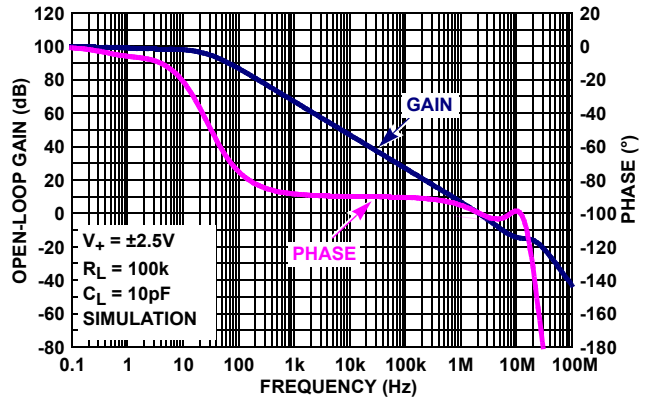

FIGURE 5. OPEN-LOOP GAIN, PHASE vs FREQUENCY, $R_L = 100k\Omega$, $C_L = 10pF$, $V_S = \pm 2.5V$

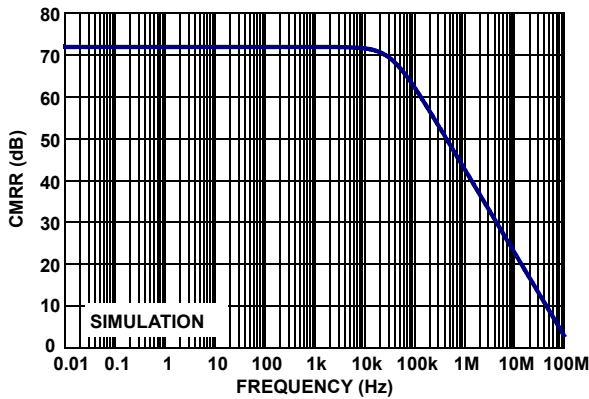

FIGURE 6. CMRR vs FREQUENCY, $V_S = \pm 2.5$

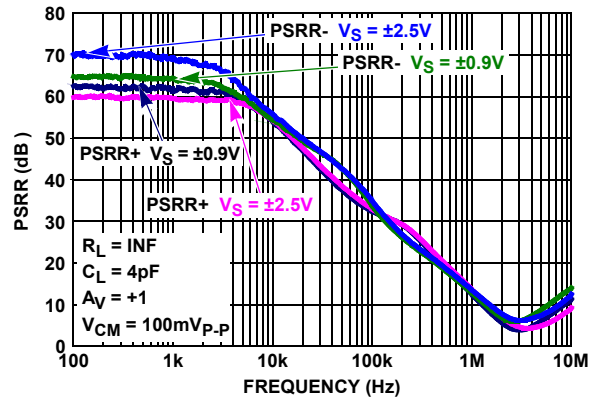

FIGURE 7. PSRR vs FREQUENCY, $V_S = \pm 0.9V, \pm 2.5V$

Typical Performance Curves $V_S = \pm 2.5V, V_{CM} = 0V, R_L = \text{Open}$, unless otherwise specified. (Continued)

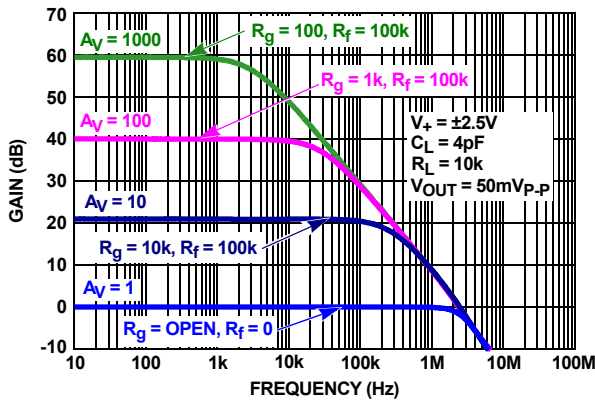

FIGURE 8. FREQUENCY RESPONSE vs CLOSED LOOP GAIN

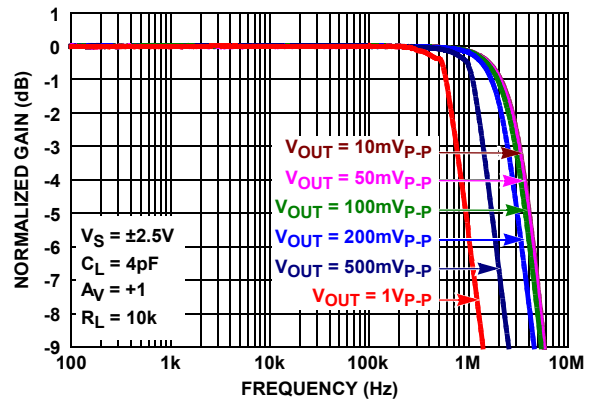

FIGURE 9. FREQUENCY RESPONSE vs V_{OUT}

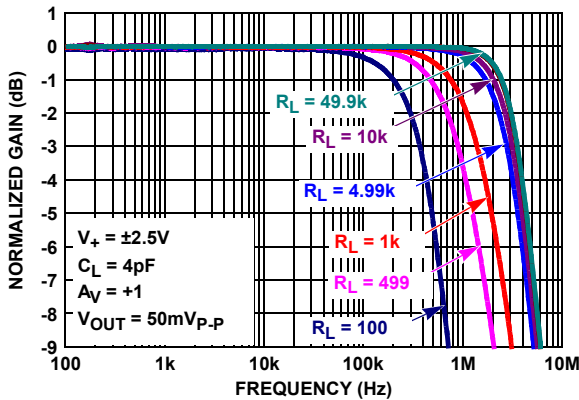

FIGURE 10. GAIN vs FREQUENCY vs R_L

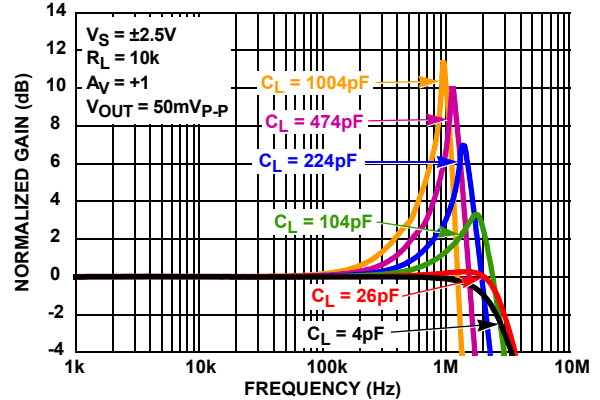

FIGURE 11. GAIN vs FREQUENCY vs C_L

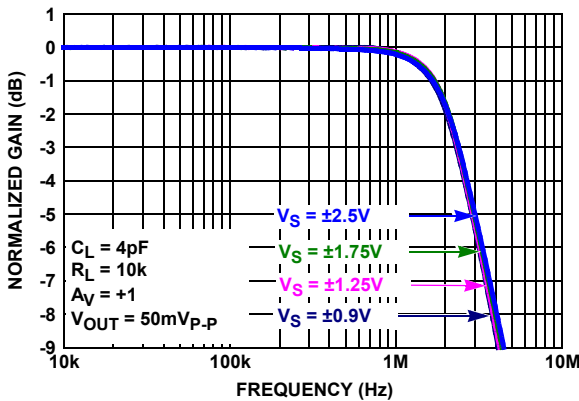

FIGURE 12. GAIN vs FREQUENCY vs SUPPLY VOLTAGE

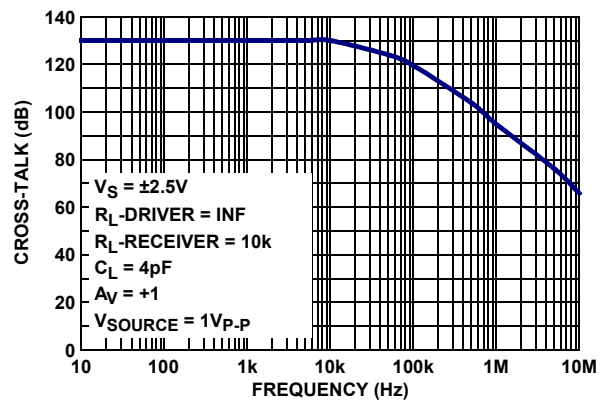

FIGURE 13. CROSSTALK, $V_S = \pm 2.5V$

Typical Performance Curves $V_S = \pm 2.5V, V_{CM} = 0V, R_L = \text{Open}$, unless otherwise specified. (Continued)

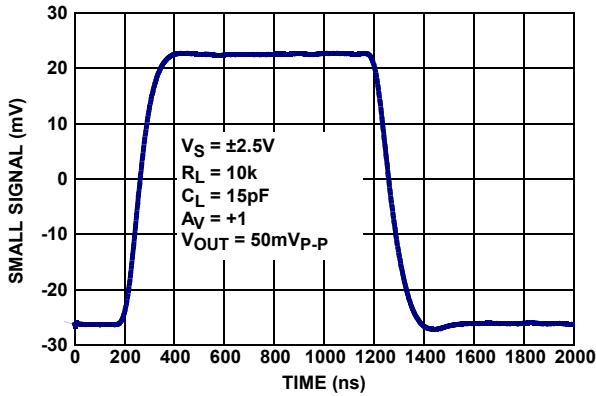

FIGURE 14. SMALL SIGNAL TRANSIENT RESPONSE, $V_S = \pm 2.5V$

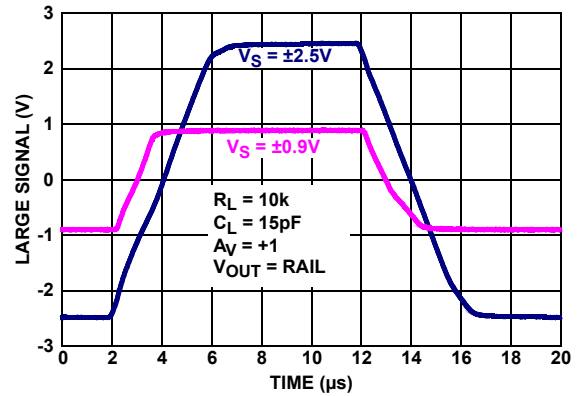

FIGURE 15. LARGE SIGNAL TRANSIENT RESPONSE vs R_L $V_S = \pm 0.9V, \pm 2.5V$

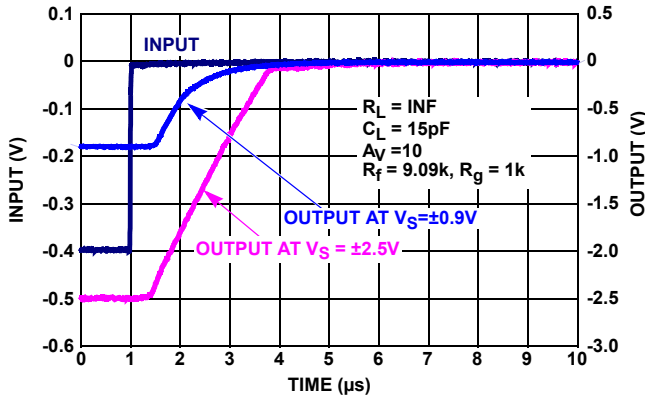

FIGURE 16. NEGATIVE OUTPUT OVERLOAD RESPONSE TIME, $V_S = \pm 0.9V, \pm 2.5V$

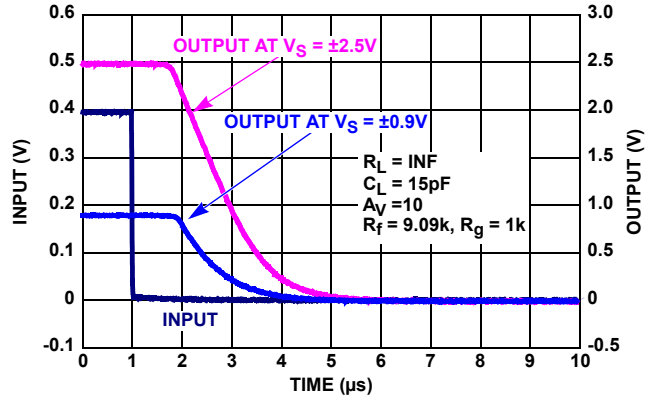

FIGURE 17. POSITIVE OUTPUT OVERLOAD RESPONSE TIME, $V_S = \pm 0.9V, \pm 2.5V$

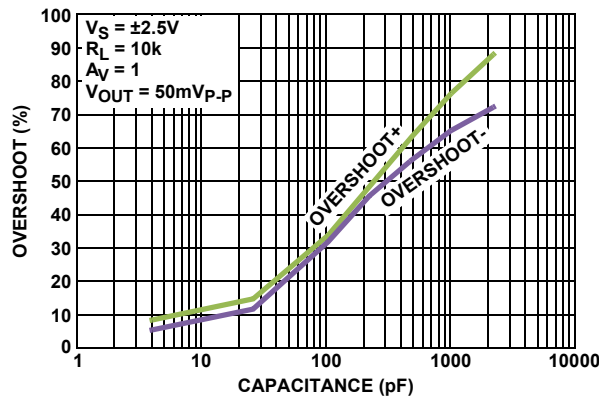

FIGURE 18. % OVERSHOOT vs LOAD CAPACITANCE, $V_S = \pm 2.5V$

Applications Information

Functional Description

The ISL28113, ISL28213 and ISL28413 are single, dual and quad, CMOS rail-to-rail input, output (RRIO) micropower operational amplifiers. They are designed to operate from single supply (1.8V to 5.5V) or dual supply ($\pm 0.9V$ to $\pm 2.75V$). The parts have an input common mode range that extends 100mV above and below the power supply voltage rails. The output stage can swing to within 15mV of the supply rails with a 10k Ω load.

Input ESD Diode Protection

All input terminals have internal ESD protection diodes to both positive and negative supply rails, limiting the input voltage to within one diode beyond the supply rails (see “Pin Descriptions - Circuit 1” on [page 3](#)). For applications where the input voltage may exceed either power supply voltage by 0.5V or more, an external series resistor must be used to ensure the input currents never exceed 20mA (see [Figure 19](#)).

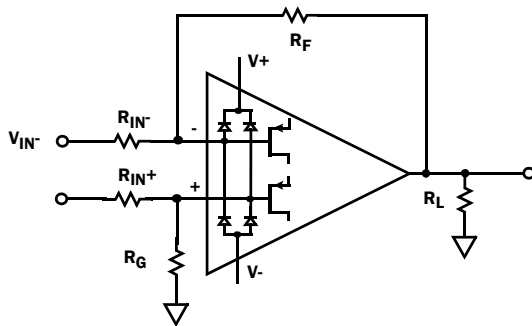

FIGURE 19. INPUT ESD DIODE CURRENT LIMITING

Output Phase Reversal

Output phase reversal is a change of polarity in the amplifier transfer function when the input voltage exceeds the supply voltage. The ISL28113, ISL28213 and ISL28413 are immune to output phase reversal, even when the input voltage is 1V beyond the supplies.

Unused Channels

If the application requires less than all amplifiers one channel, the user must configure the unused channel(s) to prevent it from oscillating. The unused channel(s) will oscillate if the input and output pins are floating. This will result in higher than expected supply currents and possible noise injection into the channel being used. The proper way to prevent this oscillation is to short the output to the inverting input and ground the positive input (as shown in [Figure 20](#)).

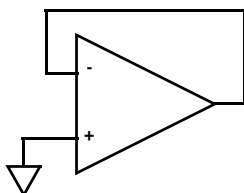

FIGURE 20. PREVENTING OSCILLATIONS IN UNUSED CHANNELS

Power Dissipation

It is possible to exceed the +125°C maximum junction temperatures under certain load, power supply conditions and ambient temperature conditions. It is therefore important to calculate the maximum junction temperature (T_{JMAX}) for all applications to determine if power supply voltages, load conditions, or package type need to be modified to remain in the safe operating area. These parameters are related using [Equation 1](#):

$$T_{JMAX} = T_{MAX} + \theta_{JA} \times PD_{MAXTOTAL} \quad (EQ. 1)$$

Where:

- $PD_{MAXTOTAL}$ is the sum of the maximum power dissipation of each amplifier in the package (PD_{MAX})
- PD_{MAX} for each amplifier can be calculated using [Equation 2](#):

$$PD_{MAX} = V_S \times I_{qMAX} + (V_S - V_{OUTMAX}) \times \frac{V_{OUTMAX}}{R_L} \quad (EQ. 2)$$

Where:

- T_{MAX} = Maximum ambient temperature
- θ_{JA} = Thermal resistance of the package
- PD_{MAX} = Maximum power dissipation of 1 amplifier
- V_S = Total supply voltage
- I_{qMAX} = Maximum quiescent supply current of 1 amplifier
- V_{OUTMAX} = Maximum output voltage swing of the application
- R_L = Load resistance

ISL28113, ISL28213 and ISL28413 SPICE Model

[Figure 21](#) shows the SPICE model schematic and [Figure 22](#) shows the net list for the SPICE model. The model is a simplified version of the actual device and simulates important AC and DC parameters. AC parameters incorporated into the model are: 1/f and flatband noise, Slew Rate, CMRR, Gain and Phase. The DC parameters are IOS, total supply current and output voltage swing. The model uses typical parameters given in the “Electrical Specifications” Table beginning on [page 4](#). The AVOL is adjusted for 85dB with the dominate pole at 100Hz. The CMRR is set 72dB, $f = 35kHz$. The input stage models the actual device to present an accurate AC representation. The model is configured for ambient temperature of +25°C.

[Figures 23](#) through [32](#) show the characterization vs simulation results for the Noise Voltage, Closed Loop Gain vs Frequency, Large Signal 5V Step Response, CMRR and Open-loop Gain Phase.

LICENSE STATEMENT

The information in this SPICE model is protected under the United States copyright laws. Intersil Corporation hereby grants users of this macromodel hereto referred to as "Licensee", a nonexclusive, nontransferable license to use this model as long as the Licensee abides by the terms of this agreement. Before using this macro-model, the Licensee should read this license. If the Licensee does not accept these terms, permission to use the model is not granted.

The Licensee may not sell, loan, rent, or license the macro-model, in whole, in part, or in modified form, to anyone outside the Licensee's company. The Licensee may modify the macro-model to suit his/her specific applications, and the Licensee may make copies of this macro-model for use within their company only.

This macro-model is provided "AS IS, WHERE IS, AND WITH NO WARRANTY OF ANY KIND EITHER EXPRESSED OR IMPLIED, INCLUDING, BUT NOT LIMITED TO, ANY IMPLIED WARRANTIES OF MERCHANTABILITY AND FITNESS FOR A PARTICULAR PURPOSE."

In no event will Intersil be liable for special, collateral, incidental, or consequential damages in connection with or arising out of the use of this macro-model. Intersil reserves the right to make changes to the product and the macro-model without prior notice.

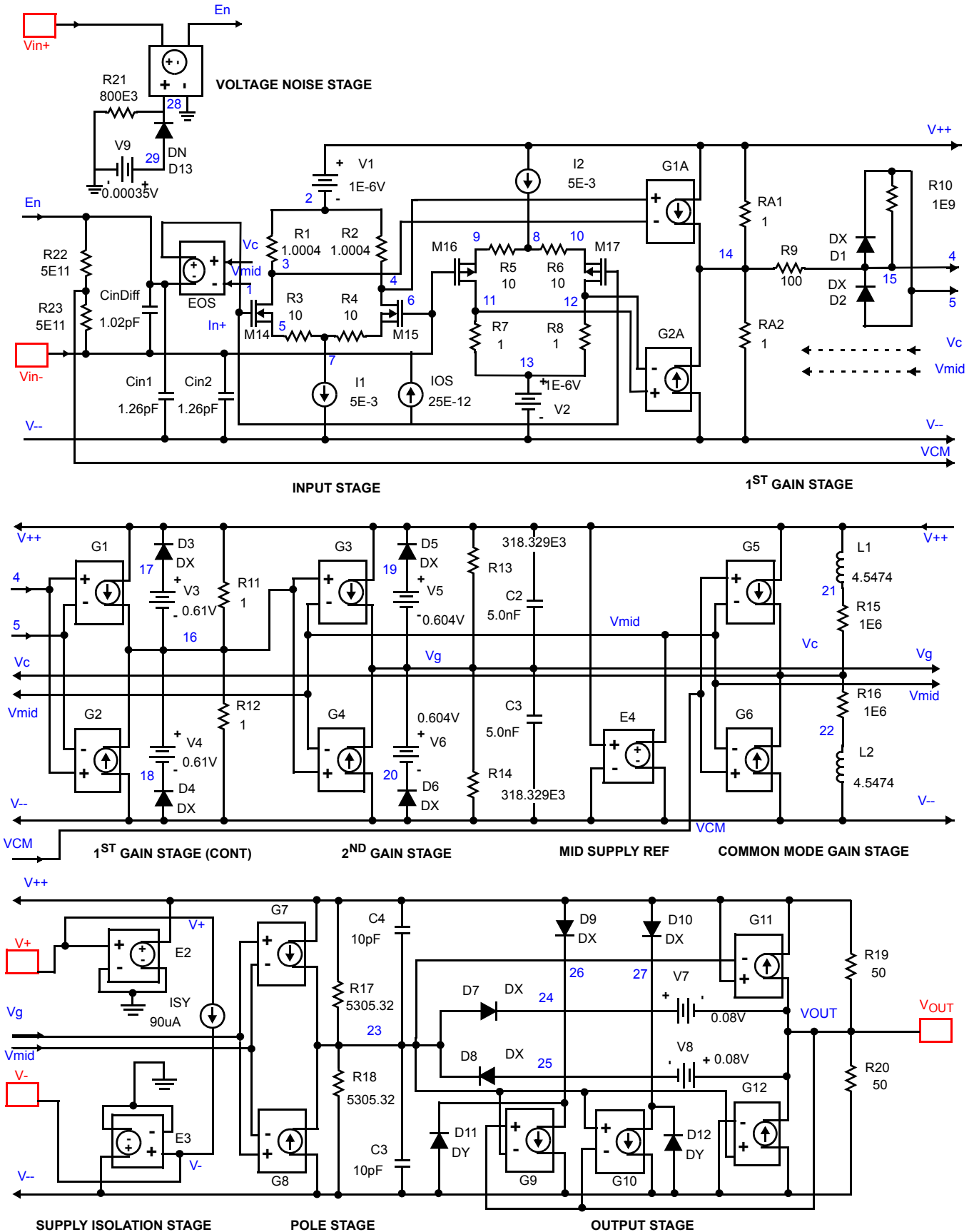

FIGURE 21. SPICE SCHEMATIC

Characterization vs Simulation Results

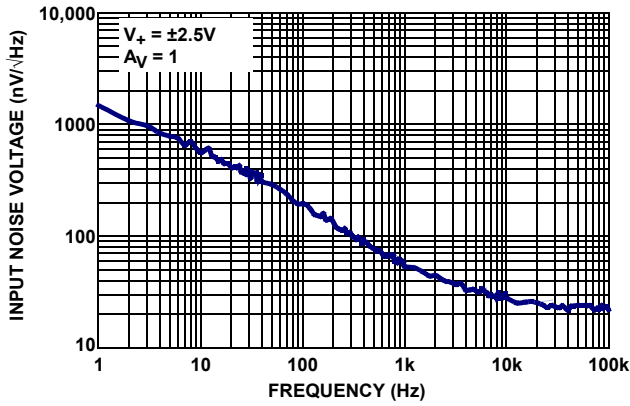

FIGURE 23. CHARACTERIZED INPUT NOISE VOLTAGE

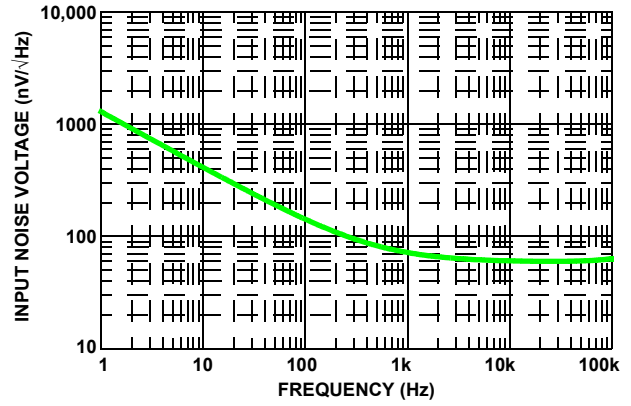

FIGURE 24. SIMULATED INPUT NOISE VOLTAGE

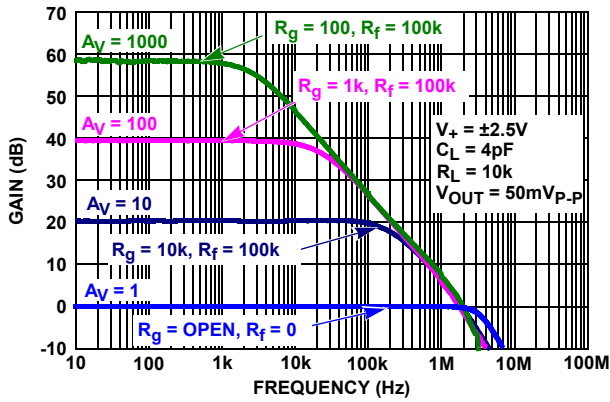

FIGURE 25. CHARACTERIZED CLOSED LOOP GAIN vs FREQUENCY

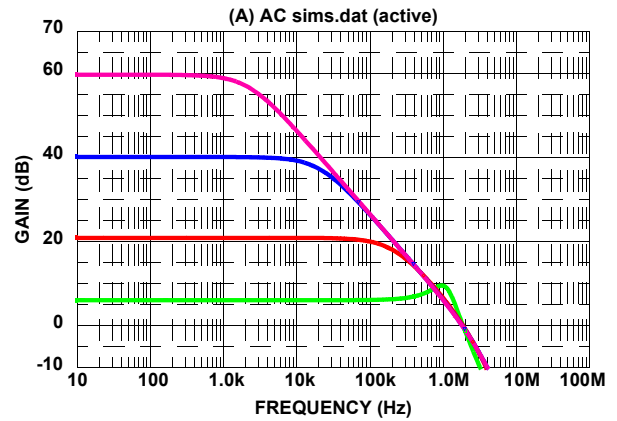

FIGURE 26. SIMULATED CLOSED LOOP GAIN vs FREQUENCY

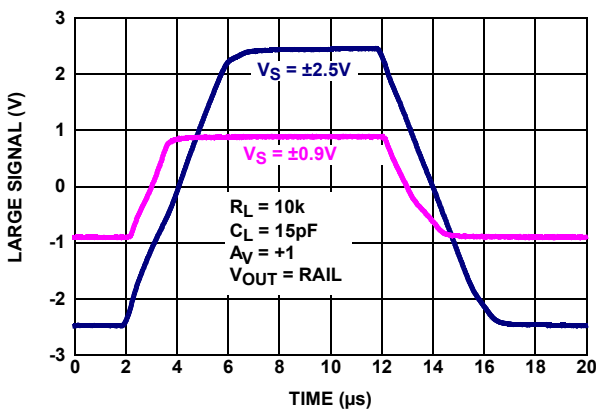

FIGURE 27. CHARACTERIZED LARGE SIGNAL TRANSIENT RESPONSE vs R_L , $V_S = \pm 0.9V, \pm 2.5V$

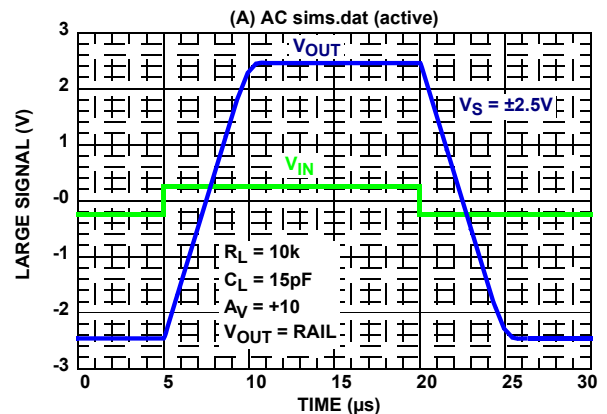

FIGURE 28. SIMULATED LARGE SIGNAL TRANSIENT RESPONSE vs R_L , $V_S = \pm 0.9V, \pm 2.5V$

Characterization vs Simulation Results (Continued)

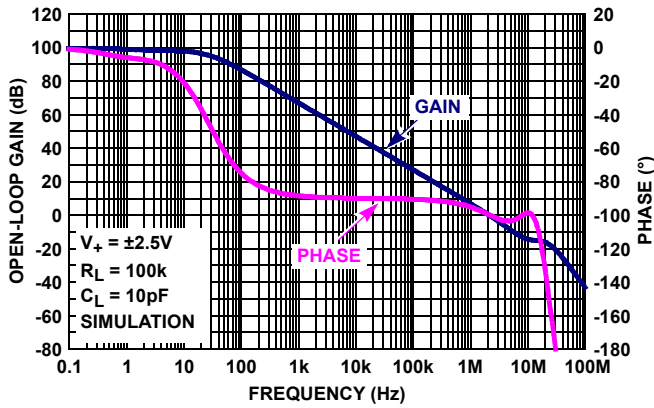

FIGURE 29. SIMULATED (DESIGN) OPEN-LOOP GAIN, PHASE vs FREQUENCY

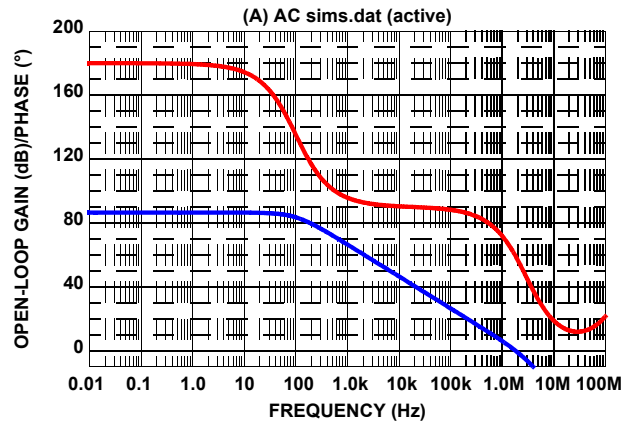

FIGURE 30. SIMULATED (SPICE) OPEN-LOOP GAIN, PHASE vs FREQUENCY

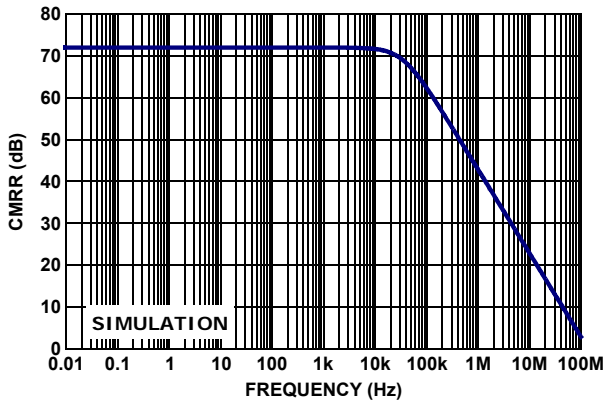

FIGURE 31. SIMULATED (DESIGN) CMRR

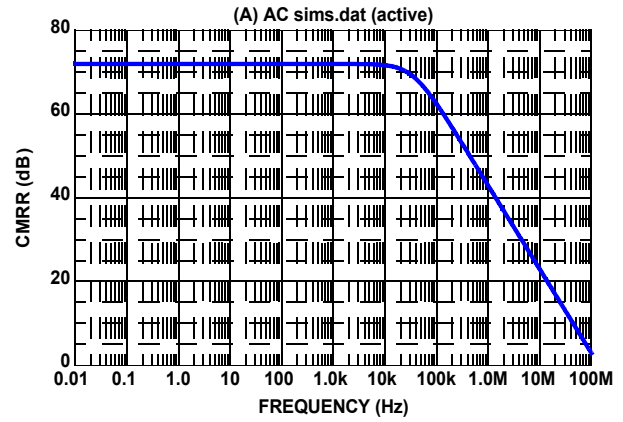

FIGURE 32. SIMULATED (SPICE) CMRR

Revision History

The revision history provided is for informational purposes only and is believed to be accurate, but not warranted. Please go to Web to make sure you have the latest Rev.

DATE	REVISION	CHANGE
4/8/15	FN6728.8	Added a row to the e_N parameter in the Electrical Specification table on page 5 to show low noise. Corrected typo on Figures 15, 16, 17 and 27 by updating the time units from "ms" to "μs". Updated the About Intersil Verbiage.
10/25/12	FN6728.7	Ordering Information changes on page 2: Removed "italics font" on "ISL28213FHZ-T7A" entry Changed on both the 28213FHZ entries, "Part Marking" from "BCP" to "BEKA" Added Note 3 Lead Finish Note for 8 Ld SOT-23 package Added Note 5 reference for all the SOT-23 and SC-70 entries (6 total), after the part marking, and added the note to Table. Added POD P8.064 on page 23
4/16/12	FN6728.6	Mask changes have been made from RevA to RevB, datasheet updated to reflect new silicon. Page 4: Vos limits changed from $\pm 5\text{mV}$ to $\pm 4\text{mV}$ at room temp and $\pm 6\text{mV}$ to $\pm 5\text{mV}$ at $+125^\circ\text{C}$. TcVos, Max spec removed, typical increased from 2 to 5. Page 7, Replaced Figure 8 with new graph. Page 7, Replaced Figure 11 with new graph. Page 8, Replaced Figure 18 with new graph.
5/18/11	FN6728.5	- On page 2, Ordering Information table: ISL28113FHZ-T7 & -T7A PKG DWG # changed from MDP0038 (Obsoleted) to P5.064A. Removed ISL28213FHZ and added "Coming Soon" to parts ISL28213FHZ-T7A and ISL28413TSSOPEVAL1Z. - On page 3, Pin Descriptions: Circuit 3 diagram, removed anti-parallel diodes from the IN+ to IN- terminals. - On page 4, Absolute Maximum Ratings: changed Differential Input Voltage from "0.5V" to "V ₋ - 0.5V to V ₊ + 0.5V". - On page 4, updated CMRR and PSRR parameters in Electrical Specifications table with test condition specifying -40°C to $+125^\circ\text{C}$ typical parameter. - On page 5, updated Note 6 ("over-temp" note) referenced in MIN and MAX column headings of Electrical Specifications table from "Parameters with MIN and/or MAX limits are 100% tested at $+25^\circ\text{C}$, unless otherwise specified. Temperature limits established by characterization and are not production tested." to new standard "Compliance to datasheet limits is assured by one or more methods: production test, characterization and/or design." - On page 9, under "Input ESD Diode Protection," removed "They also contain back to-back diodes across the input terminals." Changed "For applications where the input differential voltage is expected to exceed 0.5V, an external series resistor..." to "For applications where the input differential voltage may exceed either power supply voltage by 0.5V or more, an external series resistor...". Removed "Although the amplifier is fully protected, high input slew rates that exceed the amplifier slew rate ($\pm 1\text{V}/\mu\text{s}$) may cause output distortion." - On page 9, Figure 19: updated circuit schematic by removing back-to-back input protection diodes. - On page 18, replaced Package Outline Drawing MDP0038 (obsolete) with P5.064A.

Revision History (Continued)

The revision history provided is for informational purposes only and is believed to be accurate, but not warranted. Please go to Web to make sure you have the latest Rev. (Continued)

DATE	REVISION	CHANGE
3/23/10	FN6728.4	<p>Page 1, 2nd paragraph - Added "...SOT23-8 packages..." and changed "S08" to "SOIC8". Also global, changed S08 to SOIC8</p> <p>Pg 2, Ordering Information table: Part # ISL28213FEZ changed to ISL28213FHZ and Part Marking changed to "TBD"</p> <p>-Added Related Literature on page 1, updated ordering information by adding Eval boards. -Added to ordering information part number ISL28213FHZ 8 Ld SOT-23 Package as coming soon. -Replaced Figure 24 Simulated Input Noise Voltage with following changes: Y-axis from "10 to 100" to "10,000 to 10" Removed (A) AC sims.dat (active) from top of graph Curve changed to improve noise performance Made changes to Spice Net List as follows: -Changed Revision from "C" to "D" and added improved noise performance to Revision line. -Changed in Voltage Noise "V_V9 29 0 .00035" to "V_V9 29 0 0.45" "R_R21 28 0 800E3 TC=0,0" to "R_R21 28 0 30" -Removed TC=0 in Input Stage from R_R1 through C_Cin2 -Removed TC=0 in 1st Gain Stage from R_R9 through R_R12 -Removed TC=0 in 2nd Gain Stage from R_R13 through C_C3 -Changed in Common Mode Gain Stage with Zero "G_G5 V++ VC VCM VMID 2.5118E-10" to "G_G5 V++ VC VCM VMID 0.25118" "G_G6 V- VC VCM VMID 2.5118E-10" to "G_G6 V- VC VCM VMID 0.25118" Removed TC=0 from R_R16 through R_R23 -Changed in Pole Stage "G_G7 V++ 23 VG VMID 188.49e-6" to "G_G7 V++ 23 VG VMID 0.18849" "G_G8 V- 23 VG VMID 188.49e-6" to "G_G8 V- 23 VG VMID 0.18849" Removed TC=0 from R_R17 through C_C5 Removed TC=0 in Output Stage with Correction Current Sources from R_R19 and R_R20 Made changes to Spice Schematic Figure 21 as follows: -Input Stage - Modified connection to the EOS (voltage control voltage source) -Added to Thermal Information 8 LD SOT-23 as TBD -Added to pin configuration for the ISL28213 8 Ld SOT-23</p>
12/16/09	FN6728.3	<p>Removed "Coming Soon" from MSOP package options in the "Ordering Information" on page 2. Updated the Theta JA for the MSOP package option from 170 °C/W to 180 °C/W on page 4.</p>
11/17/09	FN6728.2	<p>Removed "Coming Soon" from SC70 and SOT-23 package options in the "Ordering Information" on page 2.</p>
11/12/09	FN6728.1	<p>Changed theta Ja to 250 from 300. Added license statement (page 10) and reference in spice model (page 12).</p>
10/26/09	FN6728.0	<p>Initial Release</p>

About Intersil

Intersil Corporation is a leading provider of innovative power management and precision analog solutions. The company's products address some of the largest markets within the industrial and infrastructure, mobile computing and high-end consumer markets.

For the most updated datasheet, application notes, related documentation and related parts, please see the respective product information page found at www.intersil.com.

You may report errors or suggestions for improving this datasheet by visiting www.intersil.com/ask.

Reliability reports are also available from our website at www.intersil.com/support

Small Outline Transistor Plastic Packages (SC70-5)

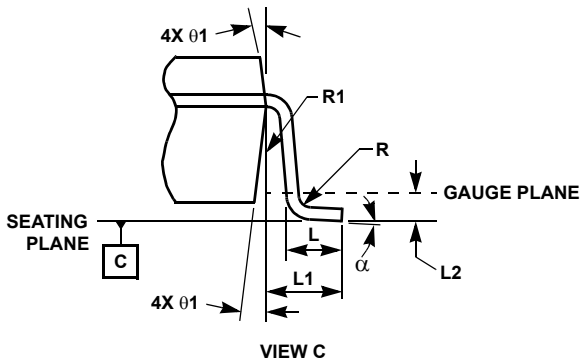
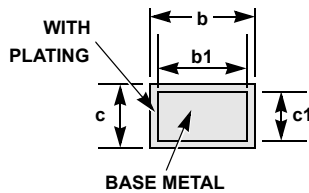
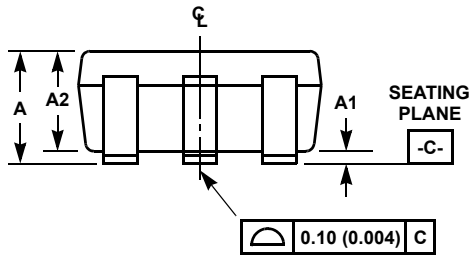
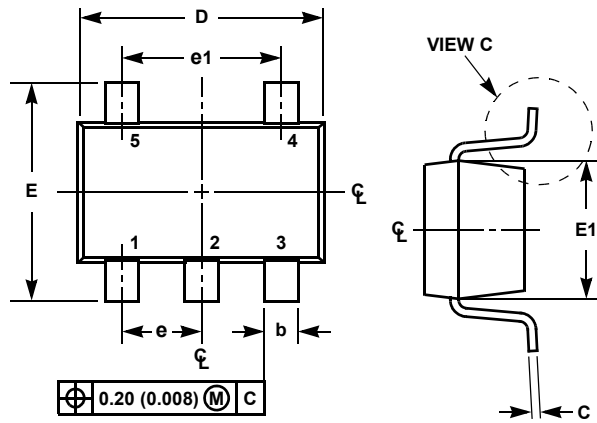

TYPICAL RECOMMENDED LAND PATTERN

P5.049

5 LEAD SMALL OUTLINE TRANSISTOR PLASTIC PACKAGE

SYMBOL	INCHES		MILLIMETERS		NOTES
	MIN	MAX	MIN	MAX	
A	0.031	0.043	0.80	1.10	-
A1	0.000	0.004	0.00	0.10	-
A2	0.031	0.039	0.80	1.00	-
b	0.006	0.012	0.15	0.30	-
b1	0.006	0.010	0.15	0.25	
c	0.003	0.009	0.08	0.22	6
c1	0.003	0.009	0.08	0.20	6
D	0.073	0.085	1.85	2.15	3
E	0.071	0.094	1.80	2.40	-
E1	0.045	0.053	1.15	1.35	3
e	0.0256 Ref		0.65 Ref		-
e1	0.0512 Ref		1.30 Ref		-
L	0.010	0.018	0.26	0.46	4
L1	0.017 Ref.		0.420 Ref.		-
L2	0.006 BSC		0.15 BSC		
α	0°	8°	0°	8°	-
N	5		5		5
R	0.004	-	0.10	-	
R1	0.004	0.010	0.15	0.25	

Rev. 3 7/07

NOTES:

1. Dimensioning and tolerances per ASME Y14.5M-1994.
2. Package conforms to EIAJ SC70 and JEDEC MO-203AA.
3. Dimensions D and E1 are exclusive of mold flash, protrusions, or gate burrs.
4. Footlength L measured at reference to gauge plane.
5. "N" is the number of terminal positions.
6. These Dimensions apply to the flat section of the lead between 0.08mm and 0.15mm from the lead tip.
7. Controlling dimension: MILLIMETER. Converted inch dimensions are for reference only.

Package Outline Drawing

M8.118A

8 LEAD MINI SMALL OUTLINE PLASTIC PACKAGE (MSOP)

Rev 0, 9/09

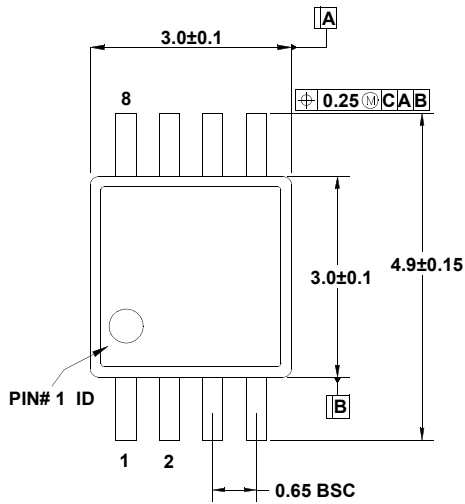

TOP VIEW

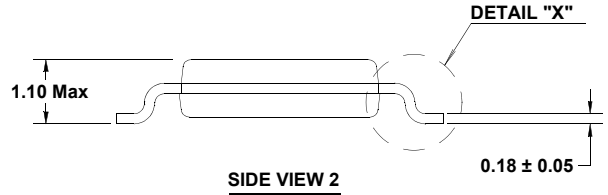

SIDE VIEW 2

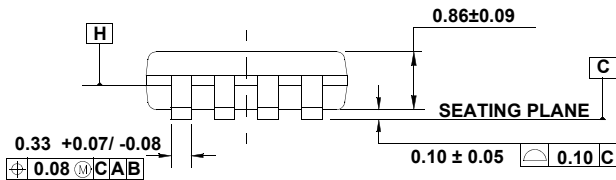

SIDE VIEW 1

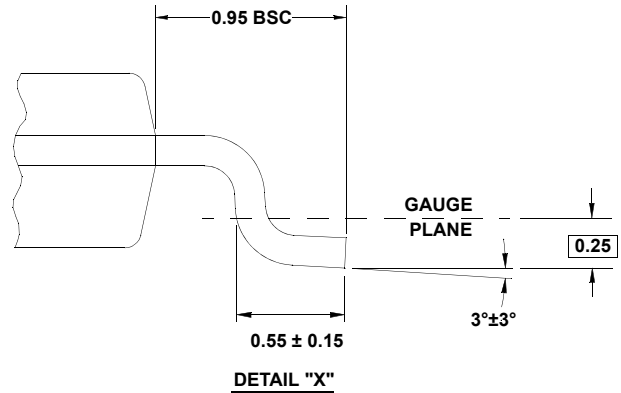

DETAIL "X"

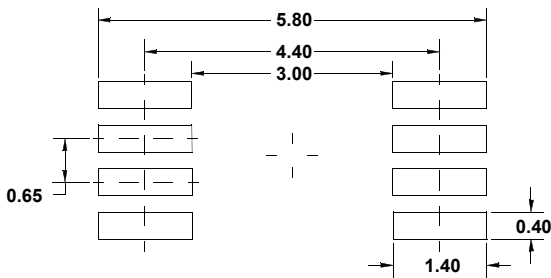

TYPICAL RECOMMENDED LAND PATTERN

NOTES:

1. Dimensions are in millimeters.
2. Dimensioning and tolerancing conform to JEDEC MO-187-AA and AMSE Y14.5m-1994.
3. Plastic or metal protrusions of 0.15mm max per side are not included.
4. Plastic interlead protrusions of 0.25mm max per side are not included.
5. Dimensions "D" and "E1" are measured at Datum Plane "H".
6. This replaces existing drawing # MDP0043 MSOP 8L.

Package Outline Drawing

M8.15E

8 LEAD NARROW BODY SMALL OUTLINE PLASTIC PACKAGE

Rev 0, 08/09

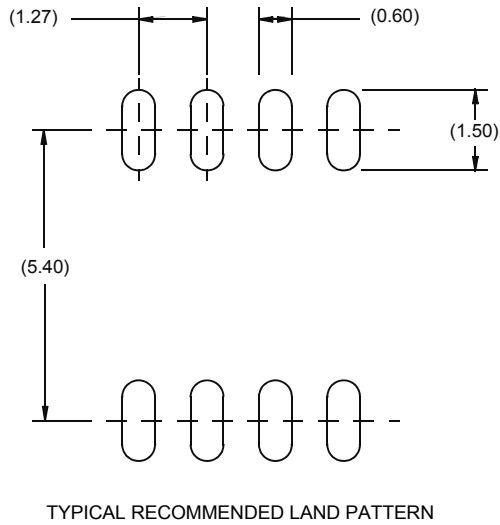
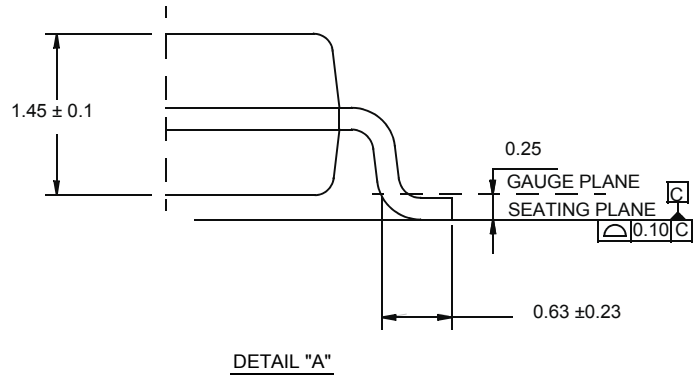
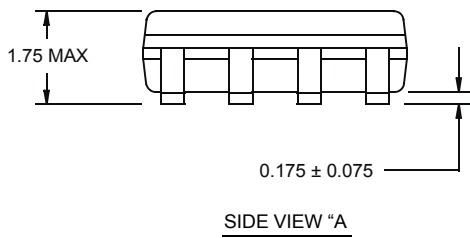
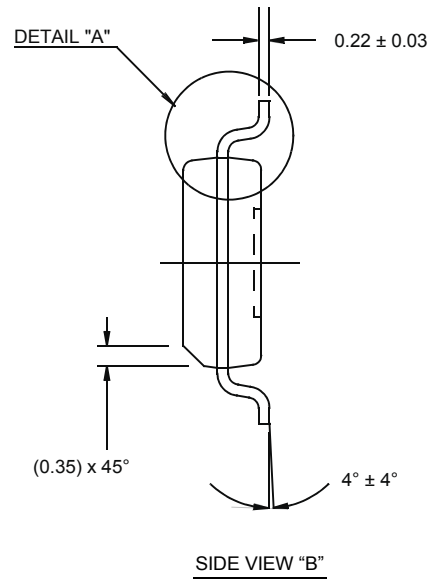
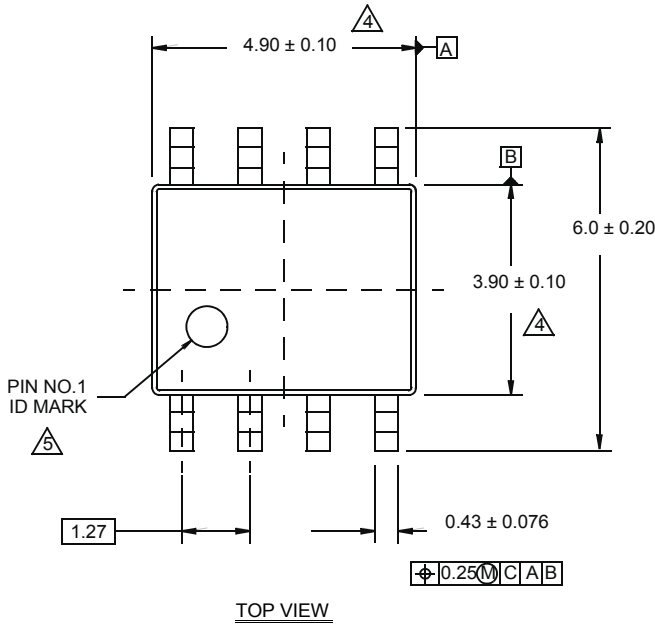

NOTES:

1. Dimensions are in millimeters.
Dimensions in () for Reference Only.
2. Dimensioning and tolerancing conform to AMSE Y14.5m-1994.
3. Unless otherwise specified, tolerance : Decimal ± 0.05
4. Dimension does not include interlead flash or protrusions.
Interlead flash or protrusions shall not exceed 0.25mm per side.
5. The pin #1 identifier may be either a mold or mark feature.
6. Reference to JEDEC MS-012.

Small Outline Package Family (SO)

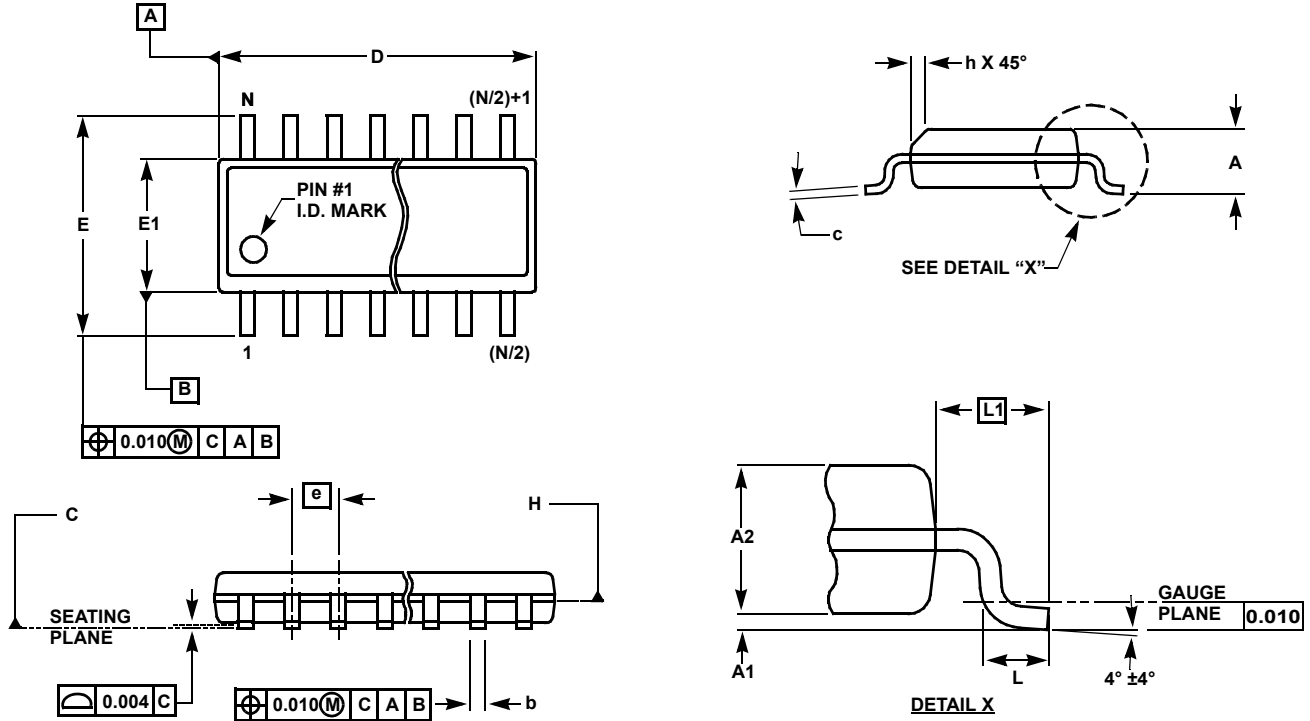

MDP0027

SMALL OUTLINE PACKAGE FAMILY (SO)

SYMBOL	INCHES							TOLERANCE	NOTES
	SO-8	SO-14	SO16 (0.150")	SO16 (0.300") (SOL-16)	SO20 (SOL-20)	SO24 (SOL-24)	SO28 (SOL-28)		
A	0.068	0.068	0.068	0.104	0.104	0.104	0.104	MAX	-
A1	0.006	0.006	0.006	0.007	0.007	0.007	0.007	± 0.003	-
A2	0.057	0.057	0.057	0.092	0.092	0.092	0.092	± 0.002	-
b	0.017	0.017	0.017	0.017	0.017	0.017	0.017	± 0.003	-
c	0.009	0.009	0.009	0.011	0.011	0.011	0.011	± 0.001	-
D	0.193	0.341	0.390	0.406	0.504	0.606	0.704	± 0.004	1, 3
E	0.236	0.236	0.236	0.406	0.406	0.406	0.406	± 0.008	-
E1	0.154	0.154	0.154	0.295	0.295	0.295	0.295	± 0.004	2, 3
e	0.050	0.050	0.050	0.050	0.050	0.050	0.050	Basic	-
L	0.025	0.025	0.025	0.030	0.030	0.030	0.030	± 0.009	-
L1	0.041	0.041	0.041	0.056	0.056	0.056	0.056	Basic	-
h	0.013	0.013	0.013	0.020	0.020	0.020	0.020	Reference	-
N	8	14	16	16	20	24	28	Reference	-

Rev. M 2/07

NOTES:

1. Plastic or metal protrusions of 0.006" maximum per side are not included.
2. Plastic interlead protrusions of 0.010" maximum per side are not included.
3. Dimensions "D" and "E1" are measured at Datum Plane "H".
4. Dimensioning and tolerancing per ASME Y14.5M-1994

Thin Shrink Small Outline Package Family (TSSOP)

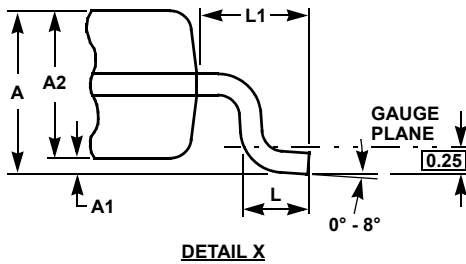
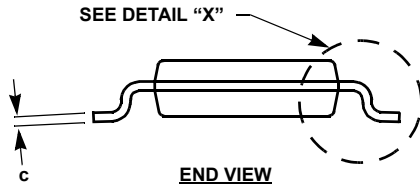
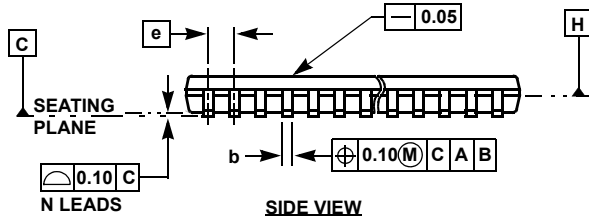
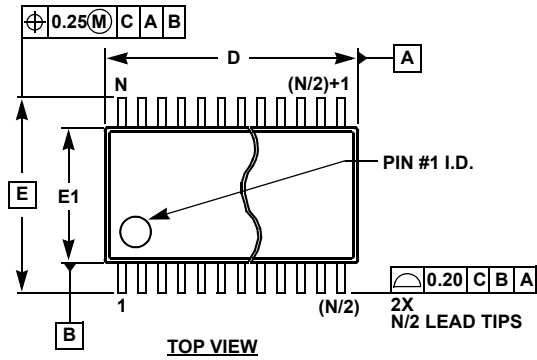

MDP0044

THIN SHRINK SMALL OUTLINE PACKAGE FAMILY

SYMBOL	MILLIMETERS					TOLERANCE
	14 LD	16 LD	20 LD	24 LD	28 LD	
A	1.20	1.20	1.20	1.20	1.20	Max
A1	0.10	0.10	0.10	0.10	0.10	±0.05
A2	0.90	0.90	0.90	0.90	0.90	±0.05
b	0.25	0.25	0.25	0.25	0.25	+0.05/-0.06
c	0.15	0.15	0.15	0.15	0.15	+0.05/-0.06
D	5.00	5.00	6.50	7.80	9.70	±0.10
E	6.40	6.40	6.40	6.40	6.40	Basic
E1	4.40	4.40	4.40	4.40	4.40	±0.10
e	0.65	0.65	0.65	0.65	0.65	Basic
L	0.60	0.60	0.60	0.60	0.60	±0.15
L1	1.00	1.00	1.00	1.00	1.00	Reference

Rev. F 2/07

NOTES:

1. Dimension "D" does not include mold flash, protrusions or gate burrs. Mold flash, protrusions or gate burrs shall not exceed 0.15mm per side.
2. Dimension "E1" does not include interlead flash or protrusions. Interlead flash and protrusions shall not exceed 0.25mm per side.
3. Dimensions "D" and "E1" are measured at dAtum Plane H.
4. Dimensioning and tolerancing per ASME Y14.5M-1994.

Small Outline Transistor Plastic Packages (SOT23-8)

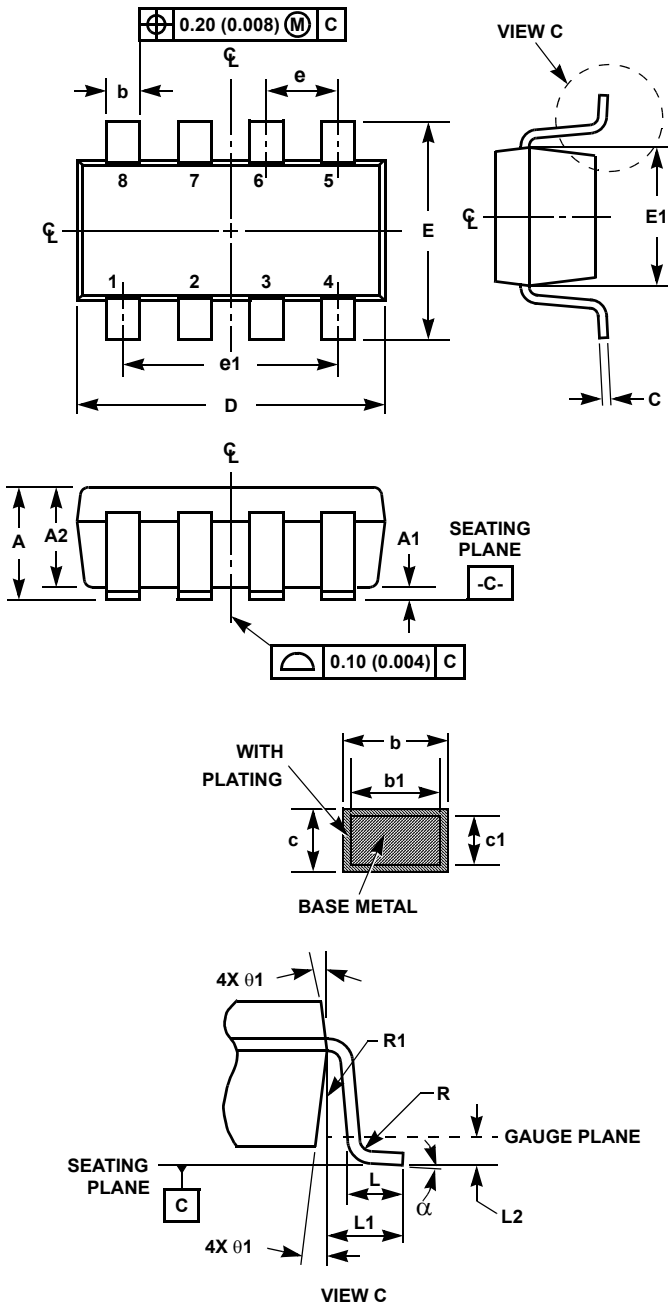

P8.064

8 LEAD SMALL OUTLINE TRANSISTOR PLASTIC PACKAGE

SYMBOL	INCHES		MILLIMETERS		NOTES
	MIN	MAX	MIN	MAX	
A	0.036	0.057	0.90	1.45	-
A1	0.000	0.0059	0.00	0.15	-
A2	0.036	0.051	0.90	1.30	-
b	0.009	0.015	0.22	0.38	-
b1	0.009	0.013	0.22	0.33	-
c	0.003	0.009	0.08	0.22	6
c1	0.003	0.008	0.08	0.20	6
D	0.111	0.118	2.80	3.00	3
E	0.103	0.118	2.60	3.00	-
E1	0.060	0.067	1.50	1.70	3
e	0.0256 Ref		0.65 Ref		-
e1	0.0768 Ref		1.95 Ref		-
L	0.014	0.022	0.35	0.55	4
L1	0.024 Ref.		0.60 Ref.		-
L2	0.010 Ref.		0.25 Ref.		-
N	8		8		5
R	0.004	-	0.10	-	-
R1	0.004	0.010	0.10	0.25	-
α	0°	8°	0°	8°	-

Rev. 2 9/03

NOTES:

1. Dimensioning and tolerance per ASME Y14.5M-1994.
2. Package conforms to EIAJ SC-74 and JEDEC MO178BA.
3. Dimensions D and E1 are exclusive of mold flash, protrusions, or gate burrs.
4. Footlength L measured at reference to gauge plane.
5. "N" is the number of terminal positions.
6. These Dimensions apply to the flat section of the lead between 0.08mm and 0.15mm from the lead tip.
7. Controlling dimension: MILLIMETER. Converted inch dimensions are for reference only

© Copyright Intersil Americas LLC 2009-2015. All Rights Reserved.
 All trademarks and registered trademarks are the property of their respective owners.

For additional products, see www.intersil.com/en/products.html

Intersil products are manufactured, assembled and tested utilizing ISO9001 quality systems as noted in the quality certifications found at www.intersil.com/en/support/qualandreliability.html

Intersil products are sold by description only. Intersil may modify the circuit design and/or specifications of products at any time without notice, provided that such modification does not, in Intersil's sole judgment, affect the form, fit or function of the product. Accordingly, the reader is cautioned to verify that datasheets are current before placing orders. Information furnished by Intersil is believed to be accurate and reliable. However, no responsibility is assumed by Intersil or its subsidiaries for its use; nor for any infringements of patents or other rights of third parties which may result from its use. No license is granted by implication or otherwise under any patent or patent rights of Intersil or its subsidiaries.

For information regarding Intersil Corporation and its products, see www.intersil.com