

IRG4PH40KPbF

INSULATED GATE BIPOLAR TRANSISTOR

Short Circuit Rated
UltraFast IGBT

Features

- High short circuit rating optimized for motor control, $t_{sc} = 10\mu s$, $V_{CC} = 720V$, $T_J = 125^\circ C$, $V_{GE} = 15V$
- Combines low conduction losses with high switching speed
- Latest generation design provides tighter parameter distribution and higher efficiency than previous generations
- Lead-Free

Benefits

- As a Freewheeling Diode we recommend our HEXFRED™ ultrafast, ultrasoft recovery diodes for minimum EMI / Noise and switching losses in the Diode and IGBT
- Latest generation 4 IGBT's offer highest power density motor controls possible
- This part replaces the IRGPH40K and IRGPH40M devices

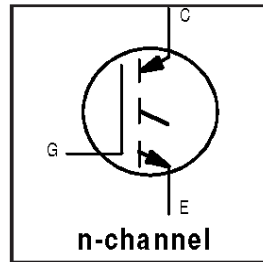

| |
|-----------------------------------|
| $V_{CES} = 1200V$ |
| $V_{CE(on)} \text{ typ.} = 2.74V$ |
| @ $V_{GE} = 15V, I_C = 15A$ |

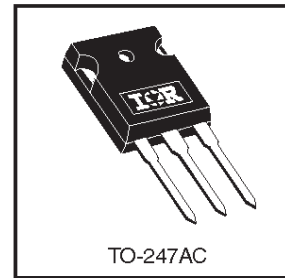

Absolute Maximum Ratings

| | Parameter | Max. | Units |
|---------------------------|------------------------------------|-----------------------------------|------------|
| V_{CES} | Collector-to-Emitter Voltage | 1200 | V |
| $I_C @ T_C = 25^\circ C$ | Continuous Collector Current | 30 | A |
| $I_C @ T_C = 100^\circ C$ | Continuous Collector Current | 15 | |
| I_{CM} | Pulsed Collector Current ① | 60 | |
| I_{LM} | Clamped Inductive Load Current ② | 60 | |
| t_{sc} | Short Circuit Withstand Time | 10 | μs |
| V_{GE} | Gate-to-Emitter Voltage | ± 20 | V |
| E_{ARV} | Reverse Voltage Avalanche Energy ③ | 180 | mJ |
| $P_D @ T_C = 25^\circ C$ | Maximum Power Dissipation | 160 | W |
| $P_D @ T_C = 100^\circ C$ | Maximum Power Dissipation | 65 | |
| T_J | Operating Junction and | -55 to +150 | $^\circ C$ |
| T_{STG} | Storage Temperature Range | | |
| | Soldering Temperature, for 10 sec. | 300 (0.063 in. (1.6mm) from case) | |
| | Mounting torque, 6-32 or M3 screw. | 10 lbf•in (1.1N•m) | |

Thermal Resistance

| | Parameter | Typ. | Max. | Units |
|-----------------|---|----------|------|--------------|
| $R_{\theta JC}$ | Junction-to-Case | — | 0.77 | $^\circ C/W$ |
| $R_{\theta CS}$ | Case-to-Sink, Flat, Greased Surface | 0.24 | — | |
| $R_{\theta JA}$ | Junction-to-Ambient, typical socket mount | — | 40 | |
| Wt | Weight | 6 (0.21) | — | g (oz) |

Electrical Characteristics @ $T_J = 25^\circ\text{C}$ (unless otherwise specified)

| | Parameter | Min. | Typ. | Max. | Units | Conditions | |
|---------------------------------|--|------|------|-----------|---------|--|--------------------------------------|
| $V_{(BR)CES}$ | Collector-to-Emitter Breakdown Voltage | 1200 | — | — | V | $V_{GE} = 0V, I_C = 250\mu A$ | |
| $V_{(BR)ECS}$ | Emitter-to-Collector Breakdown Voltage ④ | 18 | — | — | V | $V_{GE} = 0V, I_C = 1.0A$ | |
| $\Delta V_{(BR)CES}/\Delta T_J$ | Temperature Coeff. of Breakdown Voltage | — | 0.37 | — | V/°C | $V_{GE} = 0V, I_C = 1.0mA$ | |
| $V_{CE(ON)}$ | Collector-to-Emitter Saturation Voltage | — | 2.54 | — | V | $V_{GE} = 15V$ See Fig.2, 5 | |
| | | — | 2.74 | 3.4 | | | $I_C = 10A$ |
| | | — | 3.29 | — | | | $I_C = 15A$ |
| | | — | 2.53 | — | | | $I_C = 30A, T_J = 150^\circ\text{C}$ |
| $V_{GE(th)}$ | Gate Threshold Voltage | 3.0 | — | 6.0 | | $V_{CE} = V_{GE}, I_C = 250\mu A$ | |
| $\Delta V_{GE(th)}/\Delta T_J$ | Temperature Coeff. of Threshold Voltage | — | -3.3 | — | mV/°C | $V_{CE} = V_{GE}, I_C = 250\mu A$ | |
| g_{fe} | Forward Transconductance ⑤ | 8.0 | 12 | — | S | $V_{CE} = 100V, I_C = 15A$ | |
| I_{CES} | Zero Gate Voltage Collector Current | — | — | 250 | μA | $V_{GE} = 0V, V_{CE} = 1200V$ | |
| | | — | — | 2.0 | | $V_{GE} = 0V, V_{CE} = 10V, T_J = 25^\circ\text{C}$ | |
| | | — | — | 3000 | | $V_{GE} = 0V, V_{CE} = 1200V, T_J = 150^\circ\text{C}$ | |
| I_{GES} | Gate-to-Emitter Leakage Current | — | — | ± 100 | nA | $V_{GE} = \pm 20V$ | |

Switching Characteristics @ $T_J = 25^\circ\text{C}$ (unless otherwise specified)

| | Parameter | Min. | Typ. | Max. | Units | Conditions |
|--------------|-----------------------------------|------|------|------|---------|---|
| Q_g | Total Gate Charge (turn-on) | — | 94 | 140 | nC | $I_C = 15A$ $V_{CC} = 400V$ See Fig.8 $V_{GE} = 15V$ |
| Q_{ge} | Gate - Emitter Charge (turn-on) | — | 14 | 22 | | |
| Q_{gc} | Gate - Collector Charge (turn-on) | — | 37 | 55 | | |
| $t_{d(on)}$ | Turn-On Delay Time | — | 30 | — | ns | $T_J = 25^\circ\text{C}$ $I_C = 15A, V_{CC} = 960V$ $V_{GE} = 15V, R_G = 10\Omega$ Energy losses include "tail" |
| t_r | Rise Time | — | 22 | — | | |
| $t_{d(off)}$ | Turn-Off Delay Time | — | 200 | 300 | | |
| t_f | Fall Time | — | 150 | 230 | mJ | See Fig. 9,10,14 |
| E_{on} | Turn-On Switching Loss | — | 0.73 | — | | |
| E_{off} | Turn-Off Switching Loss | — | 1.66 | — | | |
| E_{ts} | Total Switching Loss | — | 2.39 | 2.9 | μs | $V_{CC} = 720V, T_J = 125^\circ\text{C}$ $V_{GE} = 15V, R_G = 10\Omega$ |
| t_{sc} | Short Circuit Withstand Time | 10 | — | — | | |
| $t_{d(on)}$ | Turn-On Delay Time | — | 29 | — | ns | $T_J = 150^\circ\text{C}$, $I_C = 15A, V_{CC} = 960V$ $V_{GE} = 15V, R_G = 10\Omega$ Energy losses include "tail" |
| t_r | Rise Time | — | 24 | — | | |
| $t_{d(off)}$ | Turn-Off Delay Time | — | 870 | — | | |
| t_f | Fall Time | — | 330 | — | mJ | See Fig. 10,11,14 |
| E_{ts} | Total Switching Loss | — | 4.93 | — | | |
| E_{on} | Turn-On Switching Loss | — | 0.37 | — | | |
| E_{off} | Turn-Off Switching Loss | — | 0.89 | — | mJ | $T_J = 25^\circ\text{C}, V_{GE} = 15V, R_G = 10\Omega$ $I_C = 10A, V_{CC} = 960V$ Energy losses include "tail" |
| E_{ts} | Total Switching Loss | — | 1.26 | — | | |
| L_E | Internal Emitter Inductance | — | 13 | — | | |
| C_{ies} | Input Capacitance | — | 1600 | — | pF | $V_{GE} = 0V$ $V_{CC} = 30V$ See Fig. 7 $f = 1.0MHz$ |
| C_{oes} | Output Capacitance | — | 77 | — | | |
| C_{res} | Reverse Transfer Capacitance | — | 26 | — | | |

Details of note ① through ⑤ are on the last page

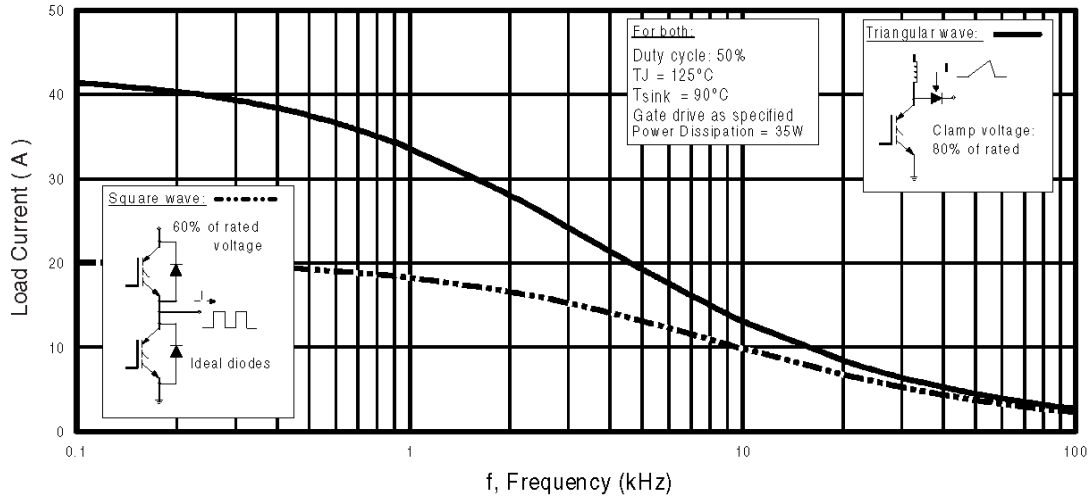

Fig. 1 - Typical Load Current vs. Frequency
(Load Current = I_{RMS} of fundamental)

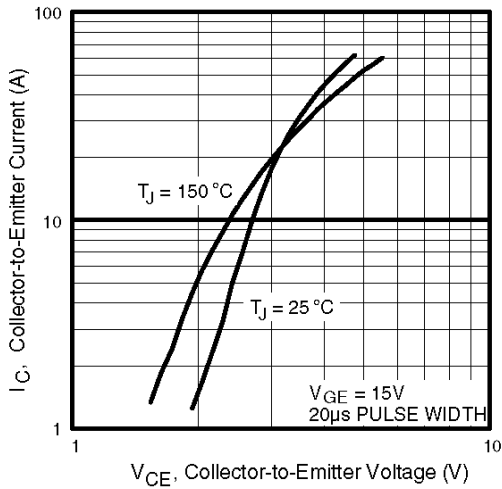

Fig. 2 - Typical Output Characteristics

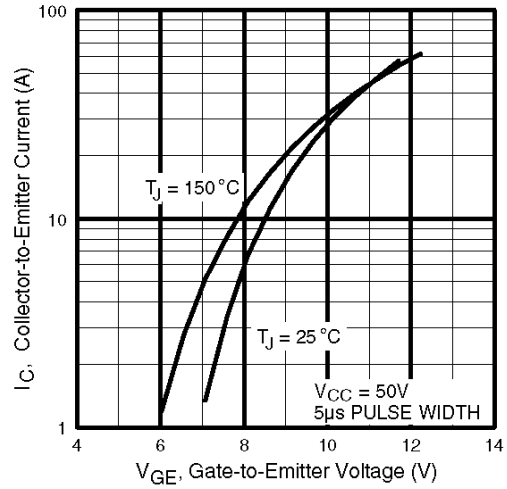

Fig. 3 - Typical Transfer Characteristics

IRG4PH40KPbF

International
IRF Rectifier

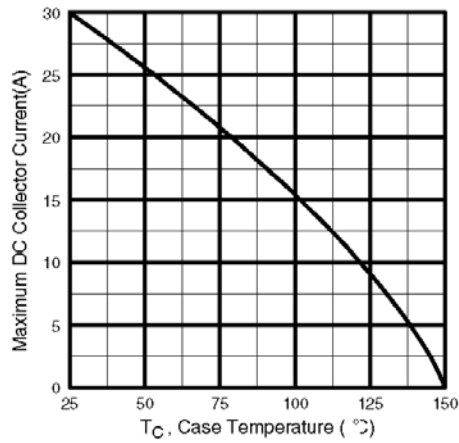

Fig. 4 - Maximum Collector Current vs. Case Temperature

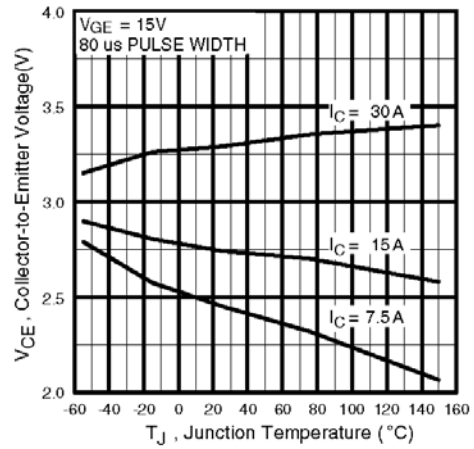

Fig. 5 - Typical Collector-to-Emitter Voltage vs. Junction Temperature

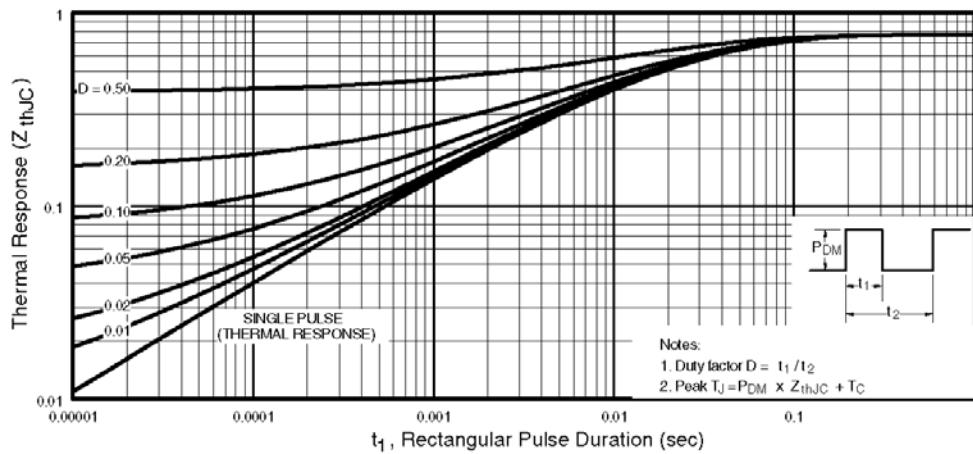

Fig. 6 - Maximum Effective Transient Thermal Impedance, Junction-to-Case

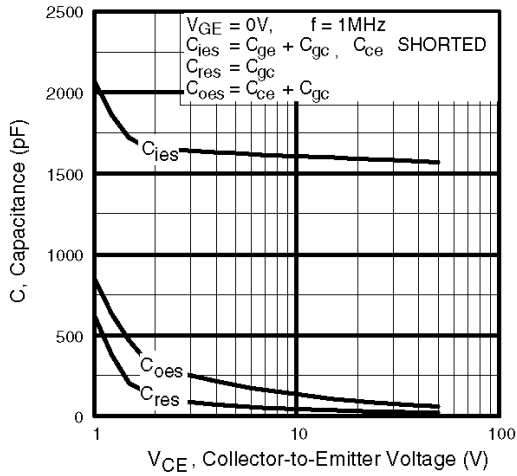

Fig. 7 - Typical Capacitance vs. Collector-to-Emitter Voltage

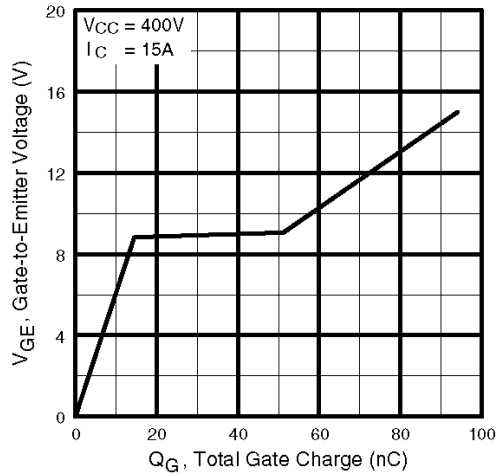

Fig. 8 - Typical Gate Charge vs. Gate-to-Emitter Voltage

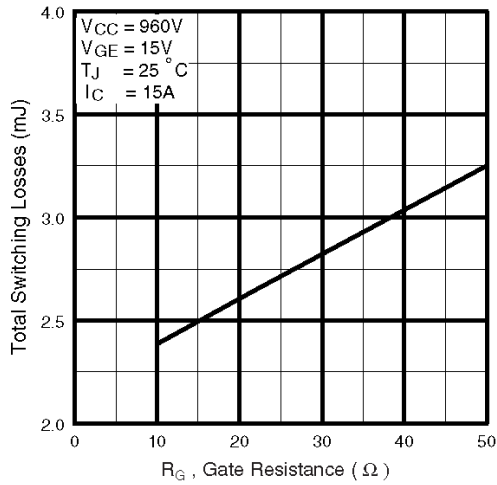

Fig. 9 - Typical Switching Losses vs. Gate Resistance

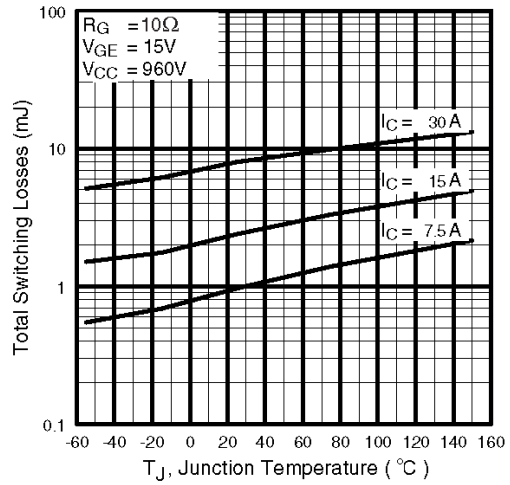

Fig. 10 - Typical Switching Losses vs. Junction Temperature

IRG4PH40KPbF

International
IR Rectifier

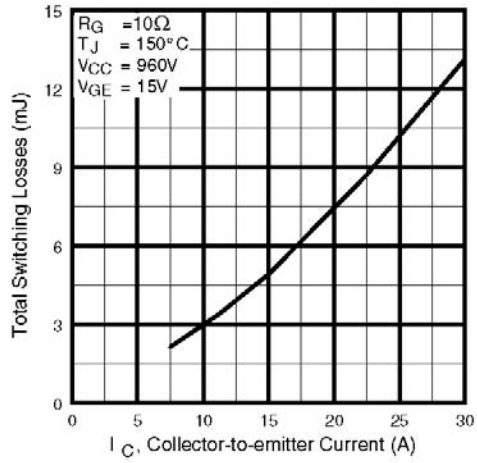

Fig. 11 - Typical Switching Losses vs. Collector-to-Emitter Current

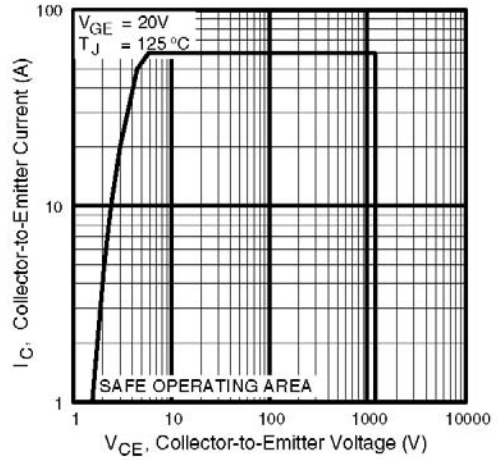

Fig. 12 - Turn-Off SOA

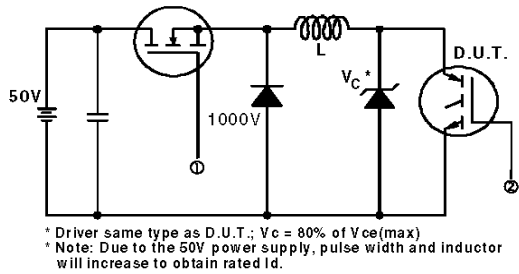

Fig. 13a - Clamped Inductive Load Test Circuit

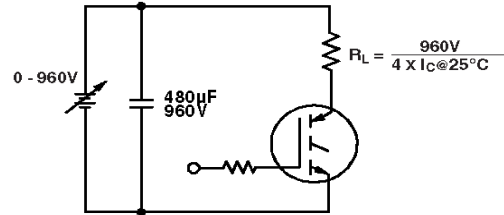

Fig. 13b - Pulsed Collector Current Test Circuit

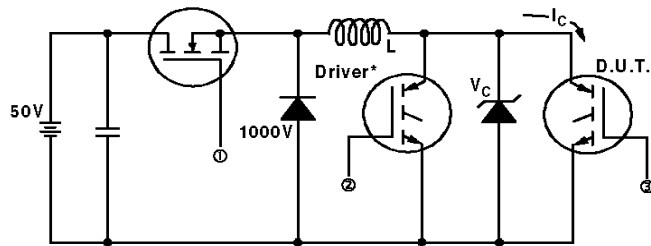

Fig. 14a - Switching Loss Test Circuit

* Driver same type as D.U.T., $V_C = 960V$

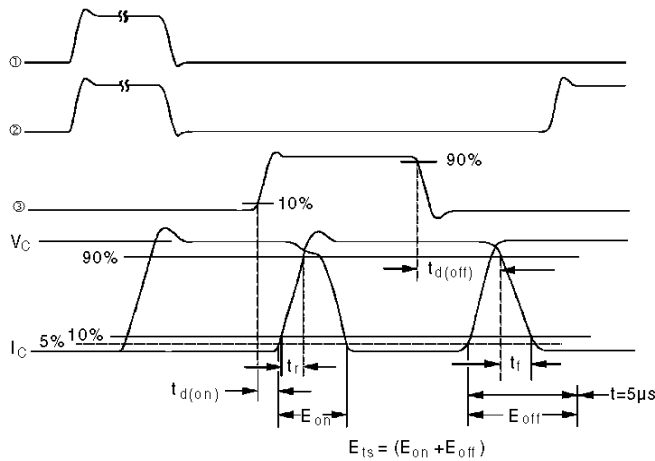

Fig. 14b - Switching Loss Waveforms

IRG4PH40KPbF

International
IR Rectifier

Notes:

- ① Repetitive rating; $V_{GE} = 20V$, pulse width limited by max. junction temperature. (See fig. 13b)
- ② $V_{CC} = 80\%(V_{CES})$, $V_{GE} = 20V$, $L = 10\mu H$, $R_G = 10\Omega$, (See fig. 13a)
- ③ Repetitive rating; pulse width limited by maximum junction temperature.
- ④ Pulse width $\leq 80\mu s$; duty factor $\leq 0.1\%$.
- ⑤ Pulse width $5.0\mu s$, single shot.

TO-247AC Package Outline

Dimensions are shown in millimeters (inches)

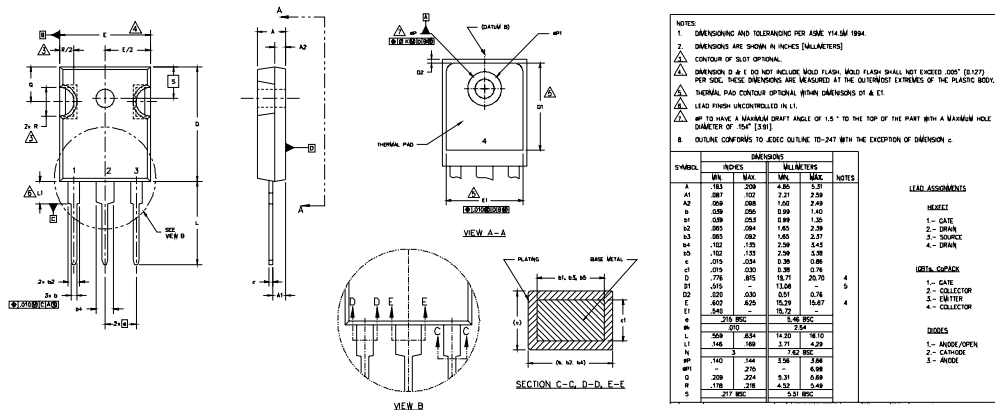

TO-247AC Part Marking Information

EXAMPLE: THIS IS AN IRFPE30
 WITH ASSEMBLY
 LOT CODE 5667
 ASSEMBLED ON WW 35, 2000
 IN THE ASSEMBLY LINE "H"
Note: "P" in assembly line
 position indicates "Lead-Free"

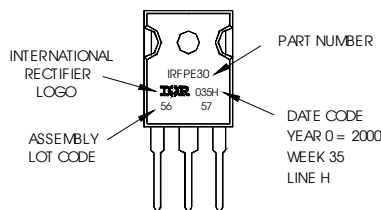

Data and specifications subject to change without notice.

International
IR Rectifier

IR WORLD HEADQUARTERS: 233 Kansas St., El Segundo, California 90245, USA Tel: (310) 252-7105
 TAC Fax: (310) 252-7903

Visit us at www.irf.com for sales contact information.08/04

www.irf.com

Note: For the most current drawings please refer to the IR website at:
<http://www.irf.com/package/>