

# IRF7322D1

FETKY™ MOSFET / Schottky Diode

- Co-packaged HEXFET® Power MOSFET and Schottky Diode
- Ideal For Buck Regulator Applications
- P-Channel HEXFET
- Low  $V_F$  Schottky Rectifier
- Generation 5 Technology
- SO-8 Footprint

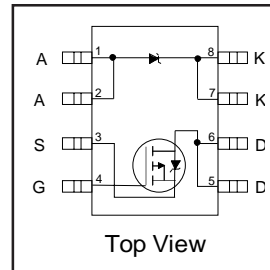

$V_{DSS} = -20V$
$R_{DS(on)} = 0.058\Omega$
Schottky $V_f = 0.39V$

## Description

The FETKY family of co-packaged MOSFETs and Schottky diodes offers the designer an innovative, board space saving solution for switching regulator and power management applications. Generation 5 HEXFET Power MOSFETs utilize advanced processing techniques to achieve extremely low on-resistance per silicon area. Combining this technology with International Rectifier's low forward drop Schottky rectifiers results in an extremely efficient device suitable for use in a wide variety of portable electronics applications.

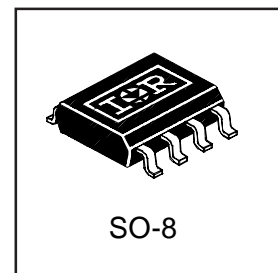

The SO-8 has been modified through a customized leadframe for enhanced thermal characteristics. The SO-8 package is designed for vapor phase, infrared or wave soldering techniques.

## Absolute Maximum Ratings ( $T_A = 25^\circ C$ unless otherwise noted)

Parameter		Maximum	Units
$I_D @ T_A = 25^\circ C$	Continuous Drain Current, $V_{GS} @ -4.5V$	-5.3	A
$I_D @ T_A = 70^\circ C$		-4.3	
$I_{DM}$		Pulsed Drain Current ①	
$P_D @ T_A = 25^\circ C$	Power Dissipation	2.0	W
$P_D @ T_A = 70^\circ C$		1.3	
	Linear Derating Factor	16	mW/°C
$V_{GS}$	Gate-to-Source Voltage	$\pm 12$	V
dv/dt	Peak Diode Recovery dv/dt ②	-5.0	V/ns
$T_J, T_{STG}$	Junction and Storage Temperature Range	-55 to +150	°C

## Thermal Resistance Ratings

Parameter		Maximum	Units
$R_{\theta JA}$	Junction-to-Ambient ④	62.5	°C/W

### Notes:

- ① Repetitive rating; pulse width limited by maximum junction temperature (see figure 9)
- ②  $I_{SD} \leq -2.9A$ ,  $di/dt \leq -77A/\mu s$ ,  $V_{DD} \leq V_{(BR)DSS}$ ,  $T_J \leq 150^\circ C$
- ③ Pulse width  $\leq 300\mu s$ ; duty cycle  $\leq 2\%$
- ④ Surface mounted on FR-4 board,  $t \leq 10sec$ .

**MOSFET Electrical Characteristics @ T<sub>J</sub> = 25°C (unless otherwise specified)**

Parameter		Min.	Typ.	Max.	Units	Conditions
V <sub>(BR)DSS</sub>	Drain-to-Source Breakdown Voltage	-20	—	—	V	V <sub>GS</sub> = 0V, I <sub>D</sub> = -250μA
R <sub>DS(on)</sub>	Static Drain-to-Source On-Resistance	—	0.049	0.062	Ω	V <sub>GS</sub> = -4.5V, I <sub>D</sub> = -2.9A ③
		—	0.082	0.098		V <sub>GS</sub> = -2.7V, I <sub>D</sub> = -1.5A ③
V <sub>GS(th)</sub>	Gate Threshold Voltage	-0.70	—	—	V	V <sub>DS</sub> = V <sub>GS</sub> , I <sub>D</sub> = -250μA
g <sub>fs</sub>	Forward Transconductance	—	5.9	—	S	V <sub>DS</sub> = -10V, I <sub>D</sub> = -1.5A
I <sub>DSS</sub>	Drain-to-Source Leakage Current	—	—	-1.0	μA	V <sub>DS</sub> = -16V, V <sub>GS</sub> = 0V
		—	—	-25		V <sub>DS</sub> = -16V, V <sub>GS</sub> = 0V, T <sub>J</sub> = 55°C
I <sub>GSS</sub>	Gate-to-Source Forward Leakage	—	—	100	nA	V <sub>GS</sub> = -12.0V
	Gate-to-Source Reverse Leakage	—	—	-100		V <sub>GS</sub> = 12.0V
Q <sub>g</sub>	Total Gate Charge	—	19	29	nC	I <sub>D</sub> = -2.9A
Q <sub>gs</sub>	Gate-to-Source Charge	—	4.0	6.1		V <sub>DS</sub> = -16V
Q <sub>gd</sub>	Gate-to-Drain ("Miller") Charge	—	7.7	12		V <sub>GS</sub> = -4.5V (see figure 6) ③
t <sub>d(on)</sub>	Turn-On Delay Time	—	15	22	ns	V <sub>DD</sub> = -10V
t <sub>r</sub>	Rise Time	—	40	60		I <sub>D</sub> = -2.9A
t <sub>d(off)</sub>	Turn-Off Delay Time	—	42	63		R <sub>G</sub> = 6.0Ω
t <sub>f</sub>	Fall Time	—	49	73		R <sub>D</sub> = 3.4Ω ③
C <sub>iss</sub>	Input Capacitance	—	780	—	pF	V <sub>GS</sub> = 0V
C <sub>oss</sub>	Output Capacitance	—	470	—		V <sub>DS</sub> = -15V
C <sub>rss</sub>	Reverse Transfer Capacitance	—	240	—		f = 1.0MHz (see figure 5)

**MOSFET Source-Drain Ratings and Characteristics**

Parameter		Min.	Typ.	Max.	Units	Conditions
I <sub>S</sub>	Continuous Source Current (Body Diode)	—	—	-2.5	A	
I <sub>SM</sub>	Pulsed Source Current (Body Diode)	—	—	-21	A	
V <sub>SD</sub>	Body Diode Forward Voltage	—	—	-1.2	V	T <sub>J</sub> = 25°C, I <sub>S</sub> = -2.9A, V <sub>GS</sub> = 0V
t <sub>rr</sub>	Reverse Recovery Time (Body Diode)	—	47	71	ns	T <sub>J</sub> = 25°C, I <sub>F</sub> = -2.9A
Q <sub>rr</sub>	Reverse Recovery Charge	—	49	73	nC	di/dt = 100A/μs ③

**Schottky Diode Maximum Ratings**

	Parameter	Max.	Units	Conditions
I <sub>F(av)</sub>	Max. Average Forward Current	2.7	A	50% Duty Cycle. Rectangular Wave, T <sub>A</sub> = 25°C See Fig. 14 T <sub>A</sub> = 70°C
		2		
I <sub>SM</sub>	Max. peak one cycle Non-repetitive Surge current	120	A	Following any rated load condition & with V <sub>RSM</sub> applied
		11		

**Schottky Diode Electrical Specifications**

	Parameter	Max.	Units	Conditions
V <sub>FM</sub>	Max. Forward voltage drop	0.50	V	I <sub>F</sub> = 1.0A, T <sub>J</sub> = 25°C
		0.62		I <sub>F</sub> = 2.0A, T <sub>J</sub> = 25°C
		0.39		I <sub>F</sub> = 1.0A, T <sub>J</sub> = 125°C
		0.57		I <sub>F</sub> = 2.0A, T <sub>J</sub> = 125°C .
I <sub>RM</sub>	Max. Reverse Leakage current	0.02	mA	V <sub>R</sub> = 20V   T <sub>J</sub> = 25°C
		8		T <sub>J</sub> = 125°C
C <sub>t</sub>	Max. Junction Capacitance	92	pF	V <sub>R</sub> = 5Vdc ( 100kHz to 1 MHz) 25°C
dv/dt	Max. Voltage Rate of Charge	3600	V/ μs	Rated V <sub>R</sub>

Power Mosfet Characteristics

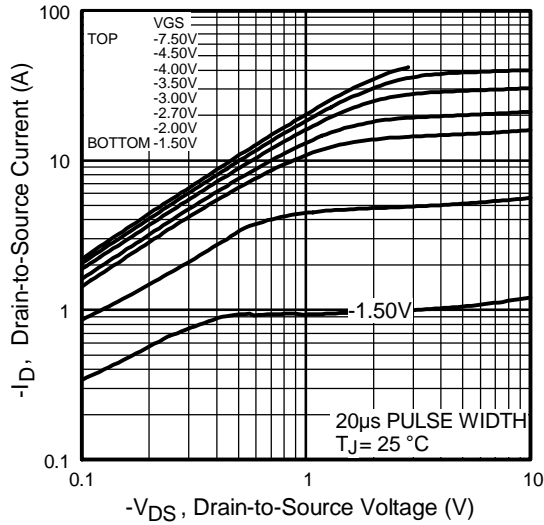

Fig 1. Typical Output Characteristics

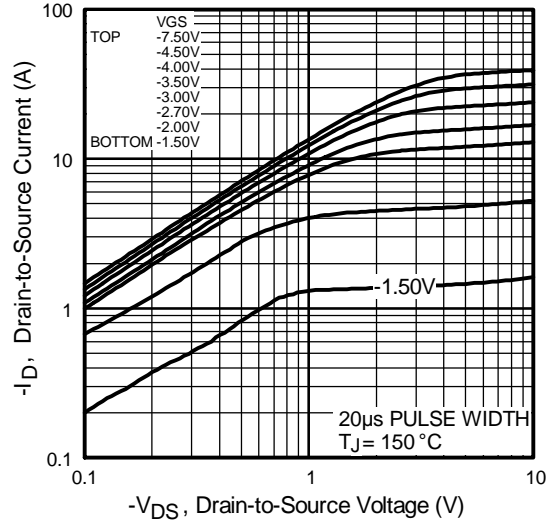

Fig 2. Typical Output Characteristics

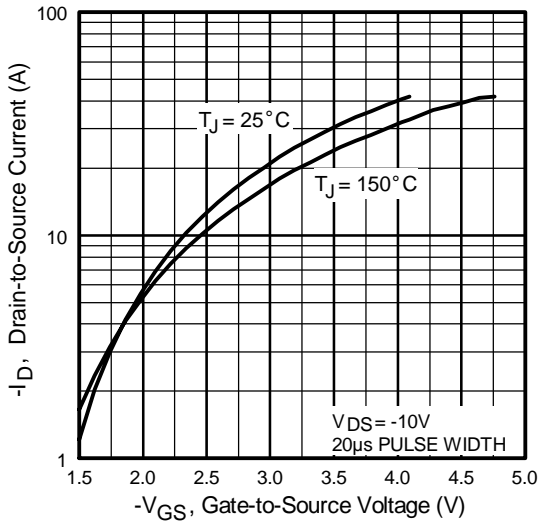

Fig 3. Typical Transfer Characteristics

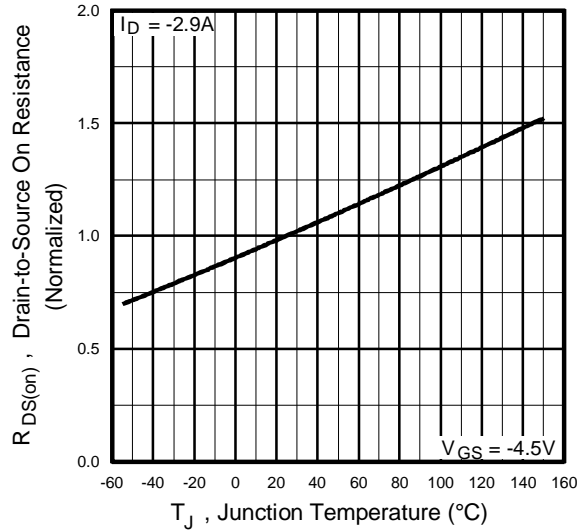

Fig 4. Normalized On-Resistance Vs. Temperature

Power Mosfet Characteristics

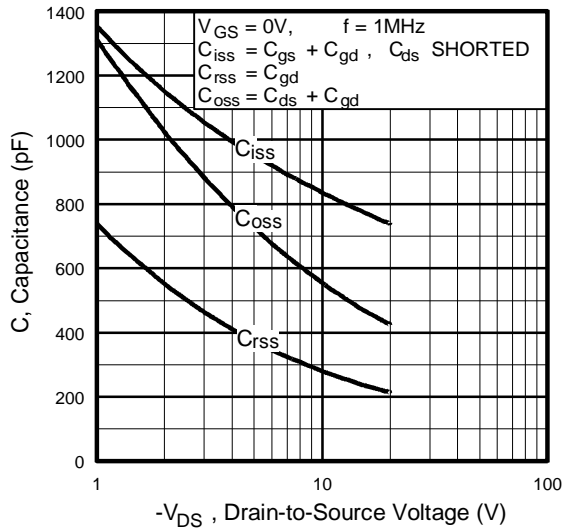

Fig 5. Typical Capacitance Vs. Drain-to-Source Voltage

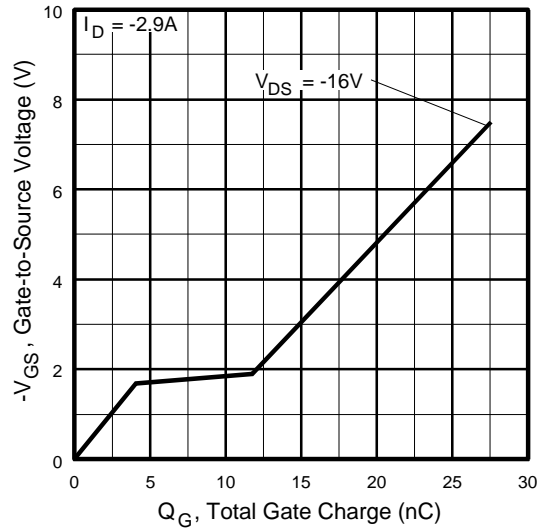

Fig 6. Typical Gate Charge Vs. Gate-to-Source Voltage

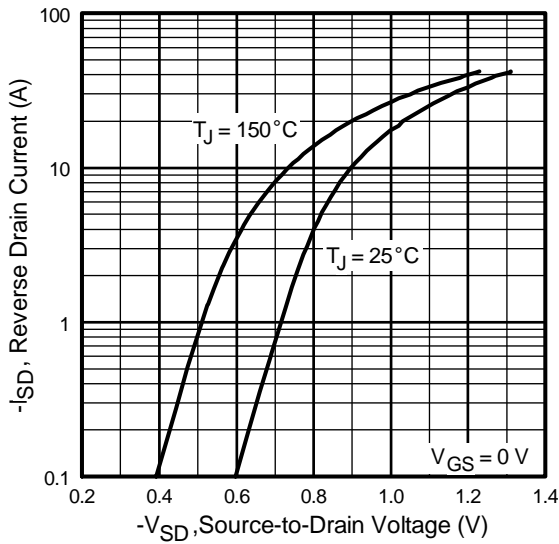

Fig 7. Typical Source-Drain Diode Forward Voltage

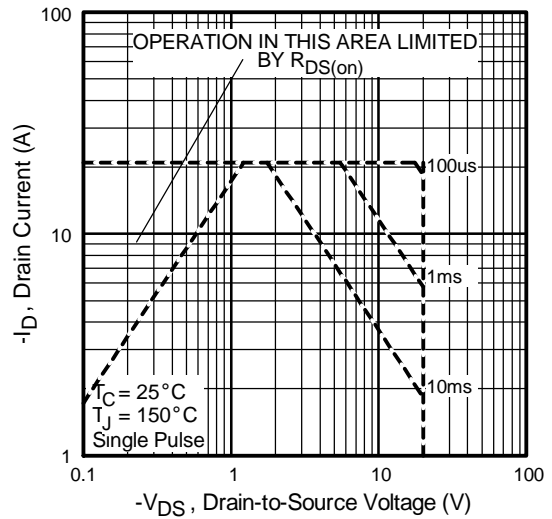

Fig 8. Maximum Safe Operating Area

Power Mosfet Characteristics

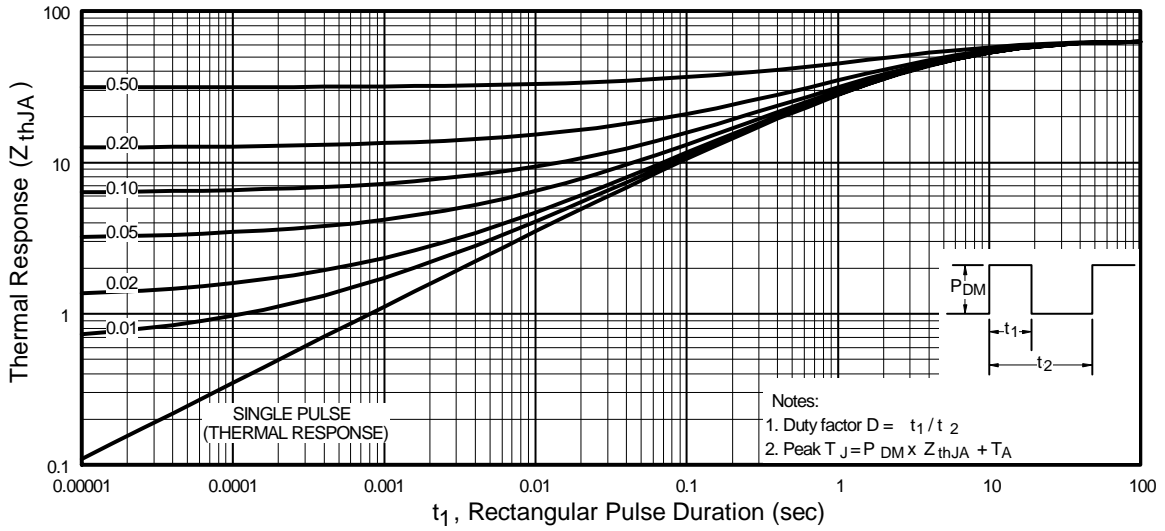

Fig 9. Maximum Effective Transient Thermal Impedance, Junction-to-Ambient

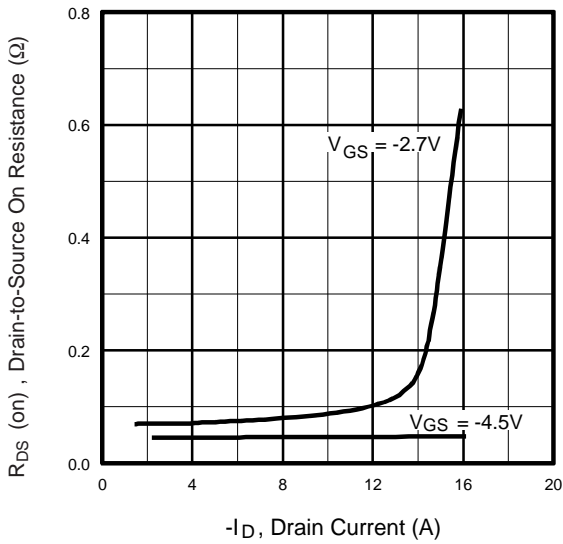

Fig 10. Typical On-Resistance Vs. Drain Current

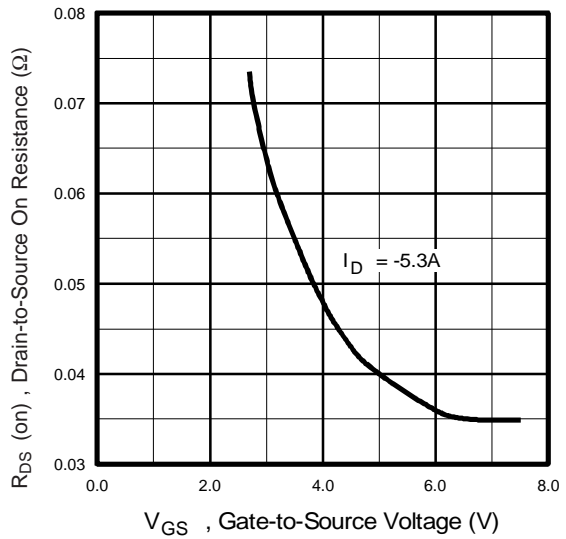

Fig 11. Typical On-Resistance Vs. Gate Voltage

Schottky Diode Characteristics

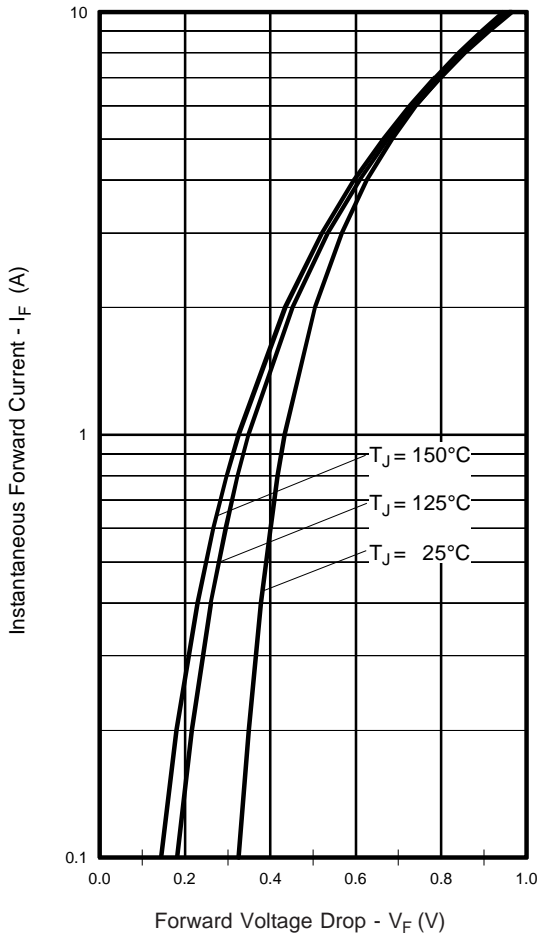

Fig. 12 - Typical Forward Voltage Drop Characteristics

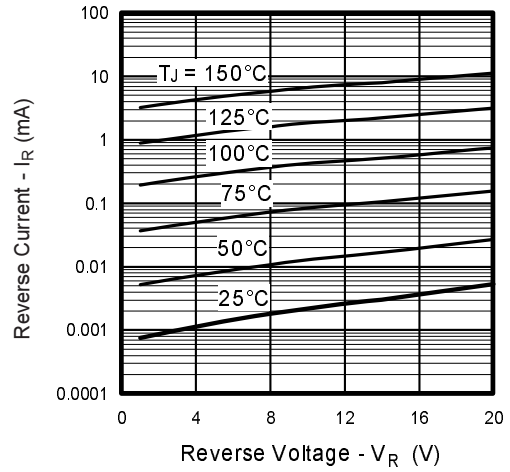

Fig. 13 - Typical Values of Reverse Current Vs. Reverse Voltage

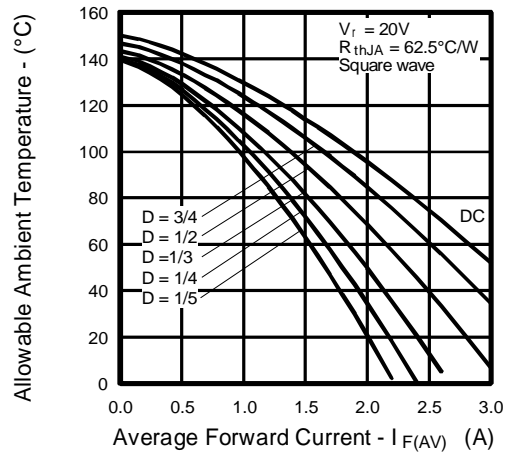
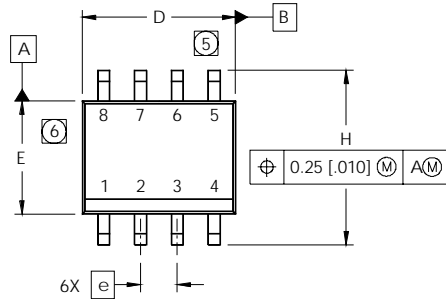

Fig.14 - Maximum Allowable Ambient Temp. Vs. Forward Current

## SO-8 (Fetky) Package Outline

Dimensions are shown in millimeters (inches)



DIM	INCHES		MILLIMETERS	
	MIN	MAX	MIN	MAX
A	.0532	.0688	1.35	1.75
A1	.0040	.0098	0.10	0.25
b	.013	.020	0.33	0.51
c	.0075	.0098	0.19	0.25
D	.189	.1968	4.80	5.00
E	.1497	.1574	3.80	4.00
e	.050 BASIC		1.27 BASIC	
e1	.025 BASIC		0.635 BASIC	
H	.2284	.2440	5.80	6.20
K	.0099	.0196	0.25	0.50
L	.016	.050	0.40	1.27
y	0°	8°	0°	8°

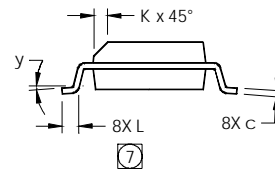
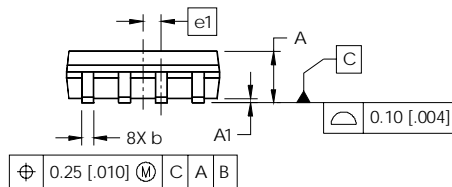

### NOTES:

1. DIMENSIONING & TOLERANCING PER ASME Y14.5M-1994.
2. CONTROLLING DIMENSION: MILLIMETER
3. DIMENSIONS ARE SHOWN IN MILLIMETERS [INCHES].
4. OUTLINE CONFORMS TO JEDEC OUTLINE MS-012AA
- ⑤ DIMENSION DOES NOT INCLUDE MOLD PROTRUSIONS. MOLD PROTRUSIONS NOT TO EXCEED 0.15 [0.006].
- ⑥ DIMENSION DOES NOT INCLUDE MOLD PROTRUSIONS. MOLD PROTRUSIONS NOT TO EXCEED 0.25 [0.010].
- ⑦ DIMENSION IS THE LENGTH OF LEAD FOR SOLDERING TO A SUBSTRATE.

### FOOTPRINT

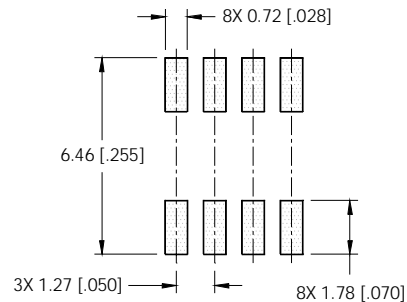

## SO-8 (Fetky) Part Marking Information

EXAMPLE: THIS IS AN IRF7807D1 (FETKY)

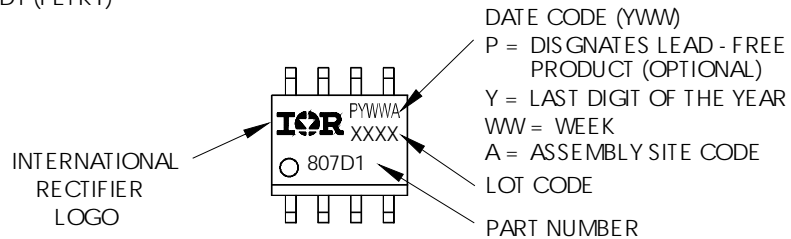

# IRF7322D1

International  
**IR** Rectifier

## SO-8 (Fetky) Tape and Reel

Dimensions are shown in millimeters (inches)

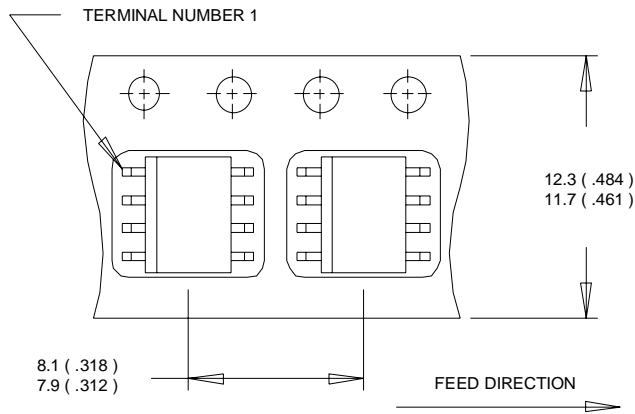

### NOTES:

1. CONTROLLING DIMENSION : MILLIMETER.
2. ALL DIMENSIONS ARE SHOWN IN MILLIMETERS(INCHES).
3. OUTLINE CONFORMS TO EIA-481 & EIA-541.

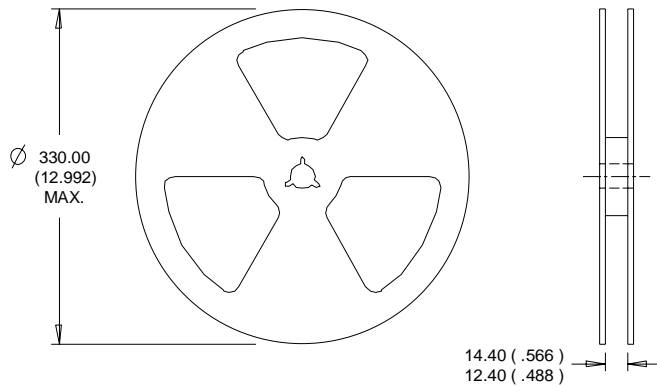

### NOTES :

1. CONTROLLING DIMENSION : MILLIMETER.
2. OUTLINE CONFORMS TO EIA-481 & EIA-541.

Data and specifications subject to change without notice.

International  
**IR** Rectifier

IR WORLD HEADQUARTERS: 233 Kansas St., El Segundo, California 90245, USA Tel: (310) 252-7105  
TAC Fax: (310) 252-7903

Visit us at [www.irf.com](http://www.irf.com) for sales contact information.10/04

[www.irf.com](http://www.irf.com)