

# IRF6718L2TRPbF IRF6718L2TR1PbF

DirectFET® Power MOSFET ②

- RoHS Compliant Containing No Lead and Bromide ①
- Dual Sided Cooling Compatible ①
- Ultra Low Package Inductance
- Very Low  $R_{DS(on)}$  for Reduced Conduction Losses
- Optimized for Active O-Ring / Efuse Applications
- Compatible with existing Surface Mount Techniques ①

Typical values (unless otherwise specified)

$V_{DS}$	$V_{GS}$	$R_{DS(on)}$	$R_{DS(on)}$		
25V max	±20V max	0.50mΩ@10V	1.0mΩ@4.5V		
$Q_{g\ tot}$	$Q_{gd}$	$Q_{gs2}$	$Q_{rr}$	$Q_{oss}$	$V_{gs(th)}$
64nC	20nC	9.4nC	67nC	50nC	1.9V

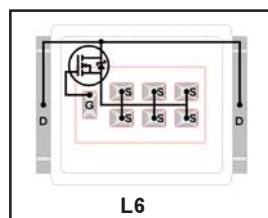

Applicable DirectFET Outline and Substrate Outline ①

S1	S2	SB		M2	M4		L4	<b>L6</b>	L8	
----	----	----	--	----	----	--	----	-----------	----	--

## Description

The IRF6718L2TRPbF combines the latest HEXFET® Power MOSFET Silicon technology with the advanced DirectFET® packaging to achieve the lowest on-state resistance in a package that has the footprint of a D-pak. The DirectFET package is compatible with existing layout geometries used in power applications, PCB assembly equipment and vapor phase, infra-red or convection soldering techniques, when application note AN-1035 is followed regarding the manufacturing methods and processes. The DirectFET package allows dual sided cooling to maximize thermal transfer in power systems.

The IRF6718L2TRPbF has extremely low Si R<sub>dson</sub> coupled with ultra low package resistance to minimize conduction losses. The IRF6718L2TRPbF has been optimized for parameters that are critical in reliable operation on Active O-Ring / Efuse / hot swap applications.

## Absolute Maximum Ratings

	Parameter	Max.	Units
$V_{DS}$	Drain-to-Source Voltage	25	V
$V_{GS}$	Gate-to-Source Voltage	±20	
$I_D @ T_A = 25^\circ C$	Continuous Drain Current, $V_{GS} @ 10V$ ③	61	A
$I_D @ T_A = 70^\circ C$	Continuous Drain Current, $V_{GS} @ 10V$ ③	52	
$I_D @ T_C = 25^\circ C$	Continuous Drain Current, $V_{GS} @ 10V$ ④	270	
$I_{DM}$	Pulsed Drain Current ⑤	490	
$E_{AS}$	Single Pulse Avalanche Energy ⑥	530	mJ
$I_{AR}$	Avalanche Current ⑤	49	A

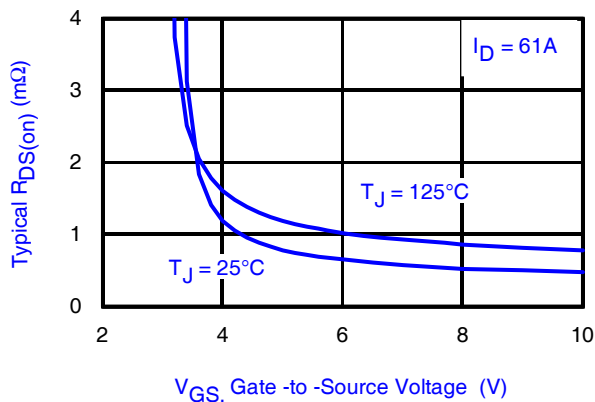

Fig 1. Typical On-Resistance vs. Gate Voltage

Notes:

- ① Click on this section to link to the appropriate technical paper.
- ② Click on this section to link to the DirectFET Website.
- ③ Surface mounted on 1 in. square Cu board, steady state.

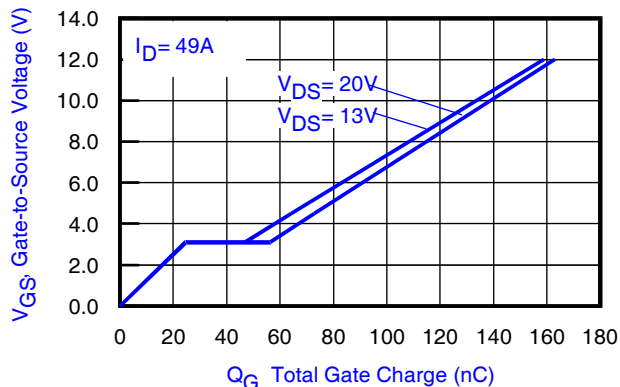

Fig 2. Typical Total Gate Charge vs Gate-to-Source Voltage

- ④  $T_C$  measured with thermocouple mounted to top (Drain) of part.
- ⑤ Repetitive rating; pulse width limited by max. junction temperature.
- ⑥ Starting  $T_J = 25^\circ C$ ,  $L = 0.44mH$ ,  $R_G = 25\Omega$ ,  $I_{AS} = 49A$ .

## Static @ $T_J = 25^\circ\text{C}$ (unless otherwise specified)

	Parameter	Min.	Typ.	Max.	Units	Conditions
$BV_{DSS}$	Drain-to-Source Breakdown Voltage	25	—	—	V	$V_{GS} = 0V, I_D = 250\mu A$
$\Delta BV_{DSS}/\Delta T_J$	Breakdown Voltage Temp. Coefficient	—	11	—	mV/°C	Reference to $25^\circ\text{C}, I_D = 1\text{mA}$
$R_{DS(on)}$	Static Drain-to-Source On-Resistance	—	0.50	0.70	mΩ	$V_{GS} = 10V, I_D = 61A$ ⑦
		—	1.0	1.4		$V_{GS} = 4.5V, I_D = 49A$ ⑦
$V_{GS(th)}$	Gate Threshold Voltage	1.35	1.90	2.35	V	$V_{DS} = V_{GS}, I_D = 150\mu A$
$\Delta V_{GS(th)}/\Delta T_J$	Gate Threshold Voltage Coefficient	—	-7.6	—	mV/°C	
$I_{DSS}$	Drain-to-Source Leakage Current	—	—	1.0	μA	$V_{DS} = 20V, V_{GS} = 0V$
		—	—	150		$V_{DS} = 20V, V_{GS} = 0V, T_J = 125^\circ\text{C}$
$I_{GSS}$	Gate-to-Source Forward Leakage	—	—	100	nA	$V_{GS} = 20V$
	Gate-to-Source Reverse Leakage	—	—	-100		$V_{GS} = -20V$
$g_{fs}$	Forward Transconductance	820	—	—	S	$V_{DS} = 13V, I_D = 49A$
$Q_g$	Total Gate Charge	—	64	96	nC	$V_{DS} = 13V$ $V_{GS} = 4.5V$ $I_D = 49A$ See Fig. 18
$Q_{gs1}$	Pre-V <sub>th</sub> Gate-to-Source Charge	—	18	—		
$Q_{gs2}$	Post-V <sub>th</sub> Gate-to-Source Charge	—	9.4	—		
$Q_{gd}$	Gate-to-Drain Charge	—	20	—		
$Q_{godr}$	Gate Charge Overdrive	—	16.6	—		
$Q_{sw}$	Switch Charge ( $Q_{gs2} + Q_{gd}$ )	—	29.4	—		
$Q_{oss}$	Output Charge	—	50	—	nC	$V_{DS} = 16V, V_{GS} = 0V$
$R_G$	Gate Resistance	—	0.90	—	Ω	
$t_{d(on)}$	Turn-On Delay Time	—	67	—	ns	$V_{DD} = 13V, V_{GS} = 4.5V$ ⑦ $I_D = 49A$ $R_G = 6.8\Omega$
$t_r$	Rise Time	—	140	—		
$t_{d(off)}$	Turn-Off Delay Time	—	47	—		
$t_f$	Fall Time	—	53	—		
$C_{iss}$	Input Capacitance	—	8910	—	pF	$V_{GS} = 0V$ $V_{DS} = 13V$ $f = 1.0\text{MHz}$
$C_{oss}$	Output Capacitance	—	2310	—		
$C_{rss}$	Reverse Transfer Capacitance	—	1115	—		

## Diode Characteristics

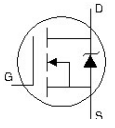
	Parameter	Min.	Typ.	Max.	Units	Conditions
$I_S$	Continuous Source Current (Body Diode)	—	—	61	A	MOSFET symbol showing the integral reverse p-n junction diode. 
$I_{SM}$	Pulsed Source Current (Body Diode) ⑤	—	—	490		
$V_{SD}$	Diode Forward Voltage	—	—	1.0	V	$T_J = 25^\circ\text{C}, I_S = 49A, V_{GS} = 0V$ ⑦
$t_{rr}$	Reverse Recovery Time	—	39	59	ns	$T_J = 25^\circ\text{C}, I_F = 49A$
$Q_{rr}$	Reverse Recovery Charge	—	67	100	nC	$di/dt = 200A/\mu s$ ⑦

### Notes:

- ⑤ Repetitive rating; pulse width limited by max. junction temperature.
- ⑦ Pulse width  $\leq 400\mu s$ ; duty cycle  $\leq 2\%$ .

**Absolute Maximum Ratings**

	Parameter	Max.	Units
$P_D @ T_A = 25^\circ\text{C}$	Power Dissipation ③	4.3	W
$P_D @ T_A = 70^\circ\text{C}$	Power Dissipation ③	3.0	
$P_D @ T_C = 25^\circ\text{C}$	Power Dissipation ④	83	
$T_P$	Peak Soldering Temperature	270	°C
$T_J$	Operating Junction and	-55 to + 175	
$T_{STG}$	Storage Temperature Range		

**Thermal Resistance**

	Parameter	Typ.	Max.	Units
$R_{\theta JA}$	Junction-to-Ambient ③	—	35	°C/W
$R_{\theta JA}$	Junction-to-Ambient ⑥	12.5	—	
$R_{\theta JA}$	Junction-to-Ambient ⑨	20	—	
$R_{\theta JC}$	Junction-to-Case ④⑩	—	1.8	
$R_{\theta J-PCB}$	Junction-to-PCB Mounted	1.0	—	
	Linear Derating Factor ③	0.029		W/°C

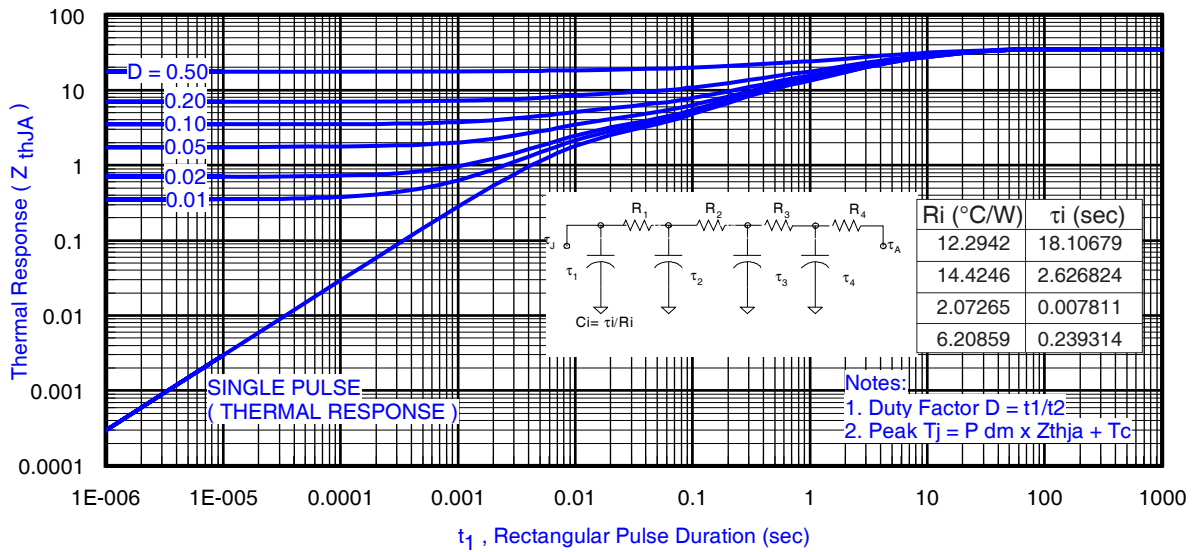

**Fig 3.** Maximum Effective Transient Thermal Impedance, Junction-to-Ambient ①  
(At lower pulse widths  $Z_{thJA}$  &  $Z_{thJC}$  are combined)

**Notes:**

- ③ Surface mounted on 1 in. square Cu board, steady state.
- ④  $T_C$  measured with thermocouple incontact with top (Drain) of part.
- ⑥ Used double sided cooling, mounting pad with large heatsink.
- ⑨ Mounted on minimum footprint full size board with metalized back and with small clip heatsink.
- ⑩  $R_{\theta}$  is measured at  $T_J$  of approximately  $90^\circ\text{C}$ .

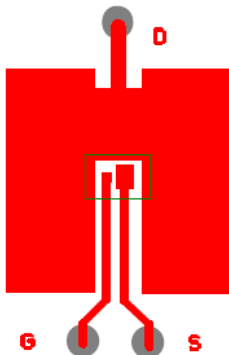

③ Surface mounted on 1 in. square Cu board (still air).

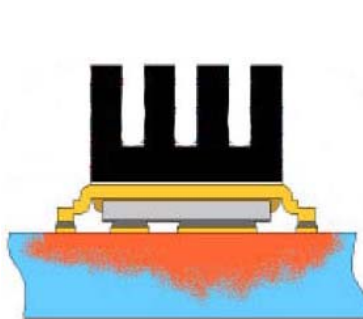

⑨ Mounted on minimum footprint full size board with metalized back and with small clip heatsink. (still air)

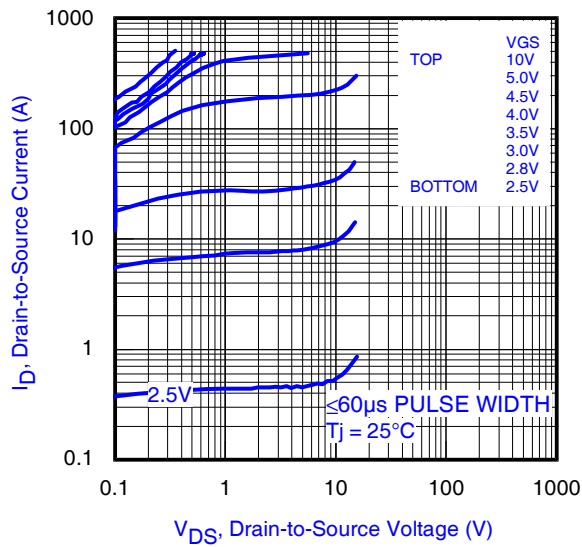

**Fig 4.** Typical Output Characteristics

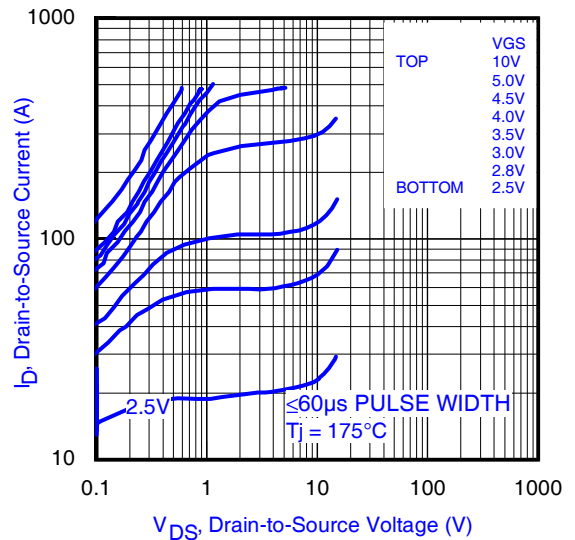

**Fig 5.** Typical Output Characteristics

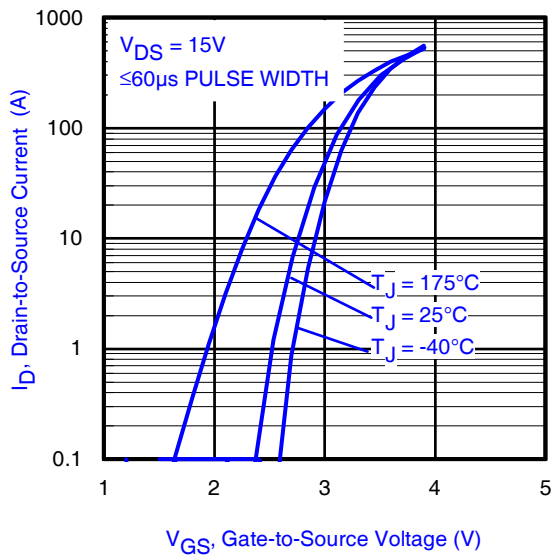

**Fig 6.** Typical Transfer Characteristics

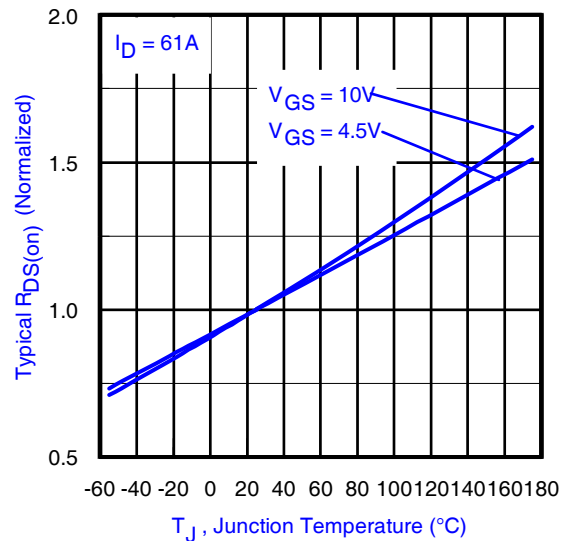

**Fig 7.** Normalized On-Resistance vs. Temperature

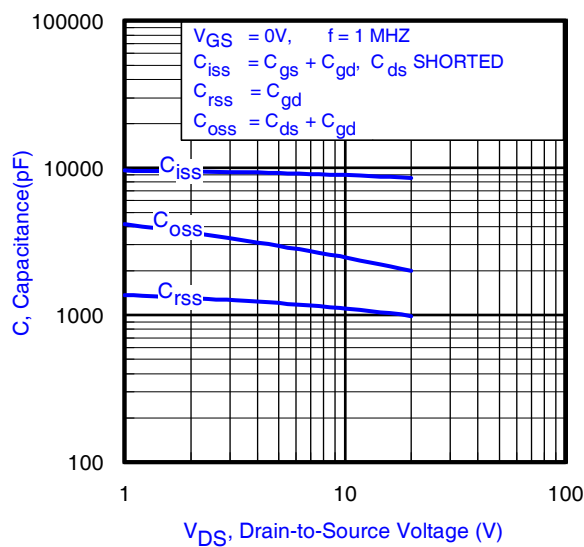

**Fig 8.** Typical Capacitance vs. Drain-to-Source Voltage

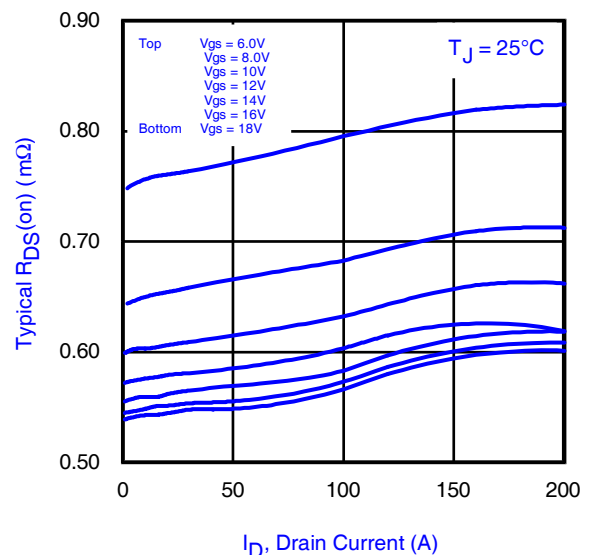

**Fig 9.** Typical On-Resistance vs. Drain Current and Gate Voltage

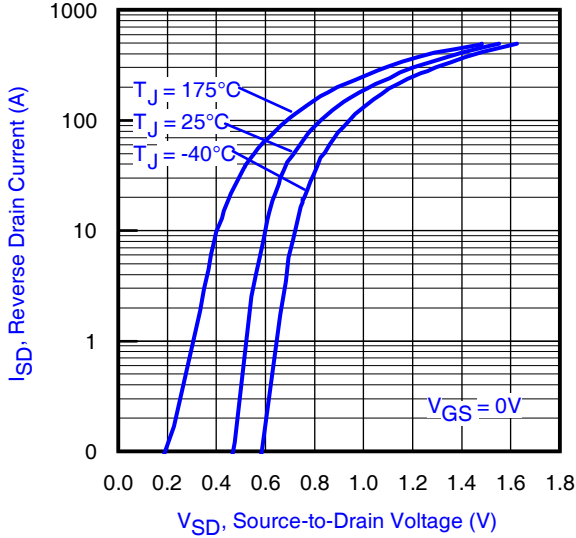

**Fig 10.** Typical Source-Drain Diode Forward Voltage

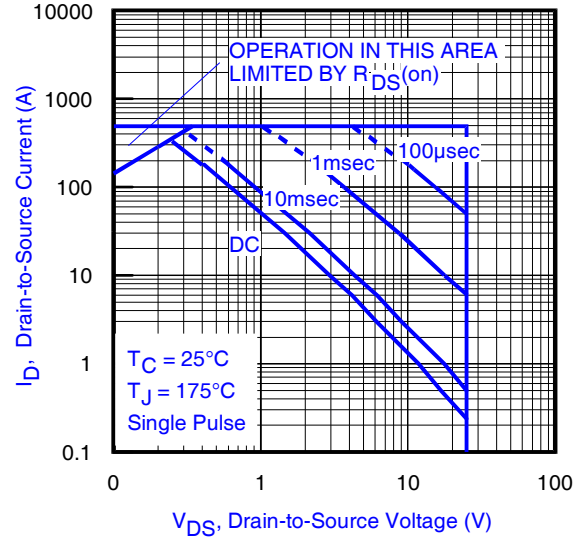

**Fig 11.** Maximum Safe Operating Area

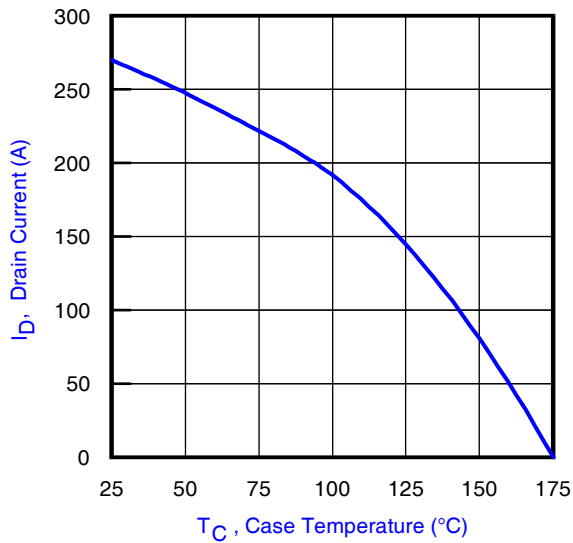

**Fig 12.** Maximum Drain Current vs. Case Temperature

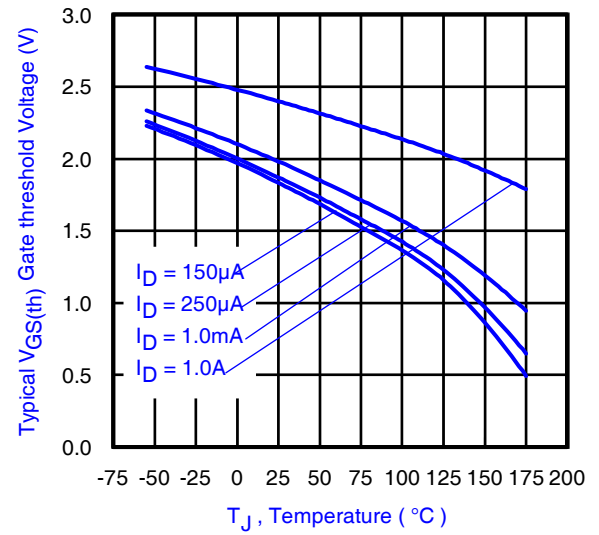

**Fig 13.** Typical Threshold Voltage vs. Junction Temperature

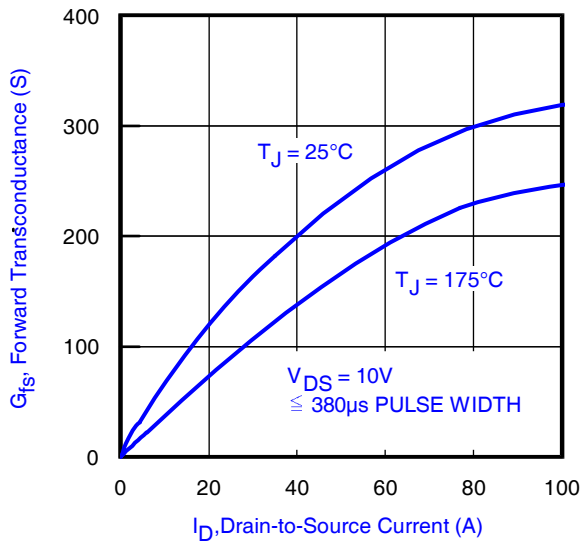

**Fig 14.** Typ. Forward Transconductance vs. Drain Current

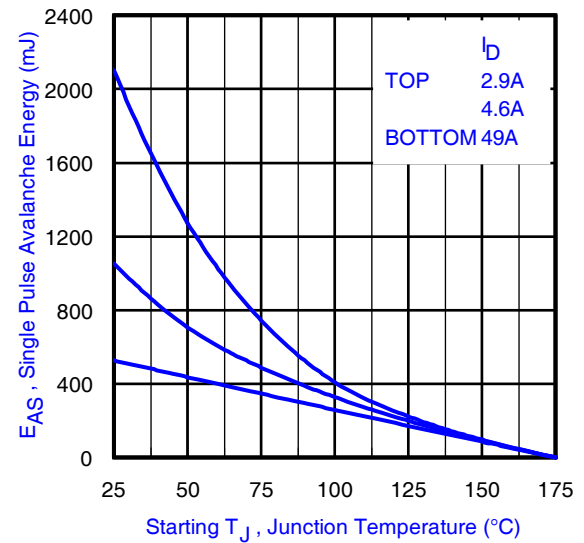

**Fig 15.** Maximum Avalanche Energy vs. Drain Current

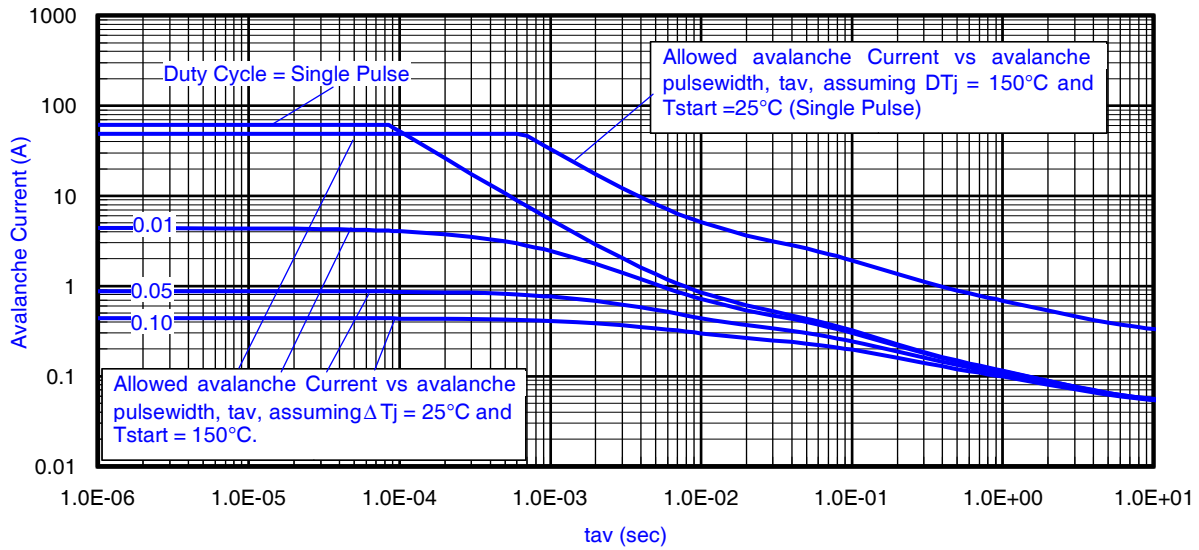

**Fig 16.** Typical Avalanche Current vs.Pulsewidth

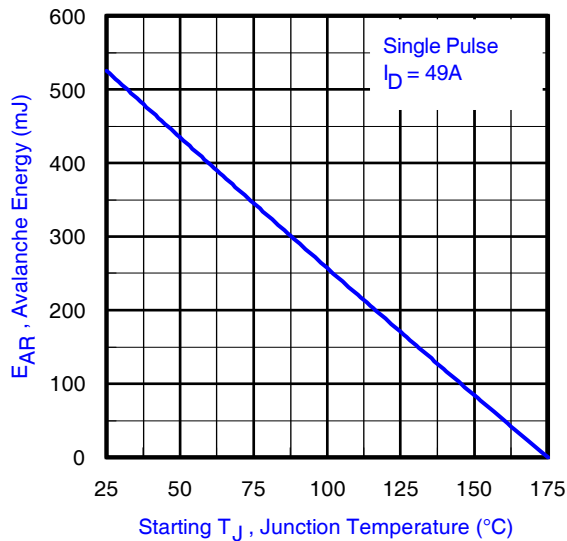

**Fig 17.** Maximum Avalanche Energy vs. Temperature

**Notes on Repetitive Avalanche Curves , Figures 16, 17:**  
(For further info, see AN-1005 at [www.irf.com](http://www.irf.com))

1. Avalanche failures assumption:  
Purely a thermal phenomenon and failure occurs at a temperature far in excess of  $T_{jmax}$ . This is validated for every part type.
2. Safe operation in Avalanche is allowed as long as  $T_{jmax}$  is not exceeded.
3. Equation below based on circuit and waveforms shown in Figures 19a, 19b.
4.  $P_{D(ave)}$  = Average power dissipation per single avalanche pulse.
5. BV = Rated breakdown voltage (1.3 factor accounts for voltage increase during avalanche).
6.  $I_{av}$  = Allowable avalanche current.
7.  $\Delta T$  = Allowable rise in junction temperature, not to exceed  $T_{jmax}$  (assumed as 25°C in Figure 16, 17).  
 $t_{av}$  = Average time in avalanche.  
 $D$  = Duty cycle in avalanche =  $t_{av} \cdot f$   
 $Z_{thJC}(D, t_{av})$  = Transient thermal resistance, see figure 11)

$$P_{D(ave)} = 1/2 ( 1.3 \cdot BV \cdot I_{av} ) = \Delta T / Z_{thJC}$$

$$I_{av} = 2\Delta T / [1.3 \cdot BV \cdot Z_{th}]$$

$$E_{AS(AR)} = P_{D(ave)} \cdot t_{av}$$

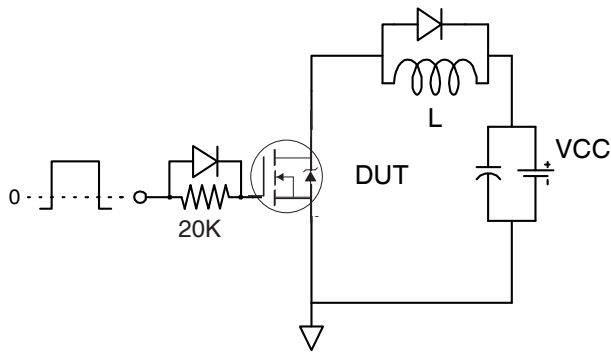

**Fig 18a.** Gate Charge Test Circuit

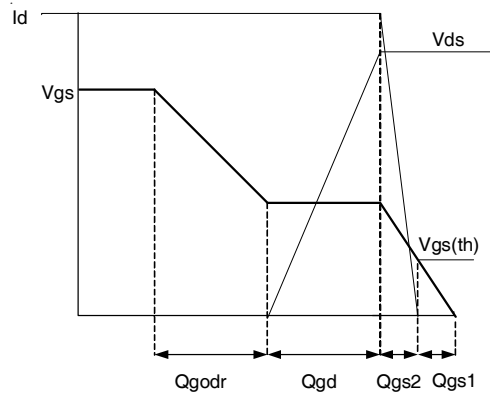

**Fig 18b.** Gate Charge Waveform

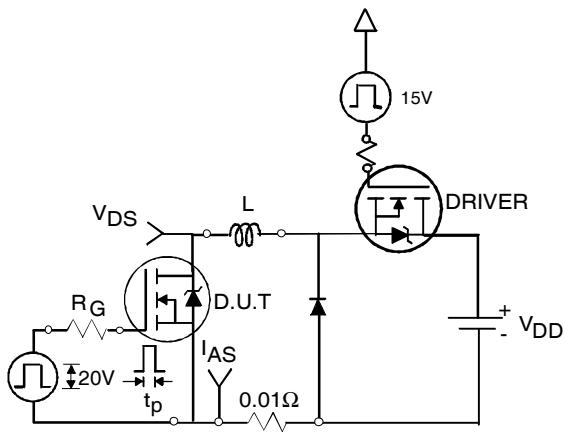

**Fig 19a.** Unclamped Inductive Test Circuit

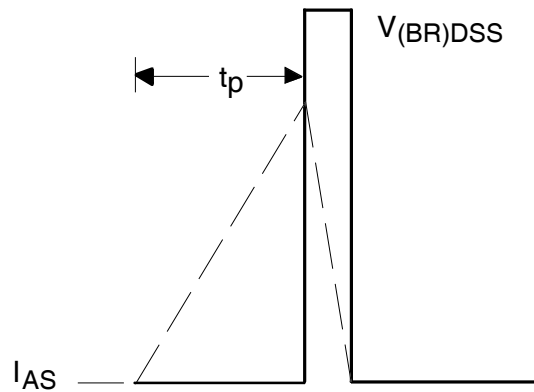

**Fig 19b.** Unclamped Inductive Waveforms

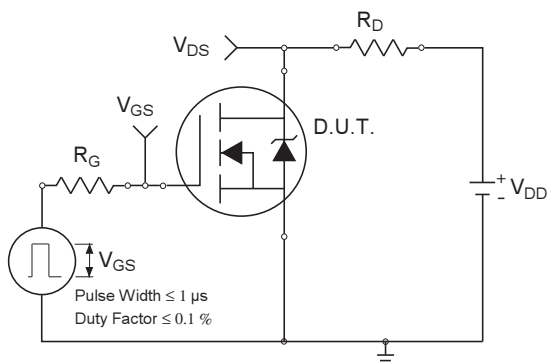

**Fig 20a.** Switching Time Test Circuit

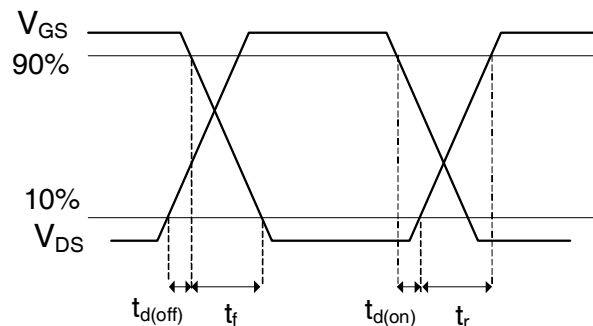

**Fig 20b.** Switching Time Waveforms

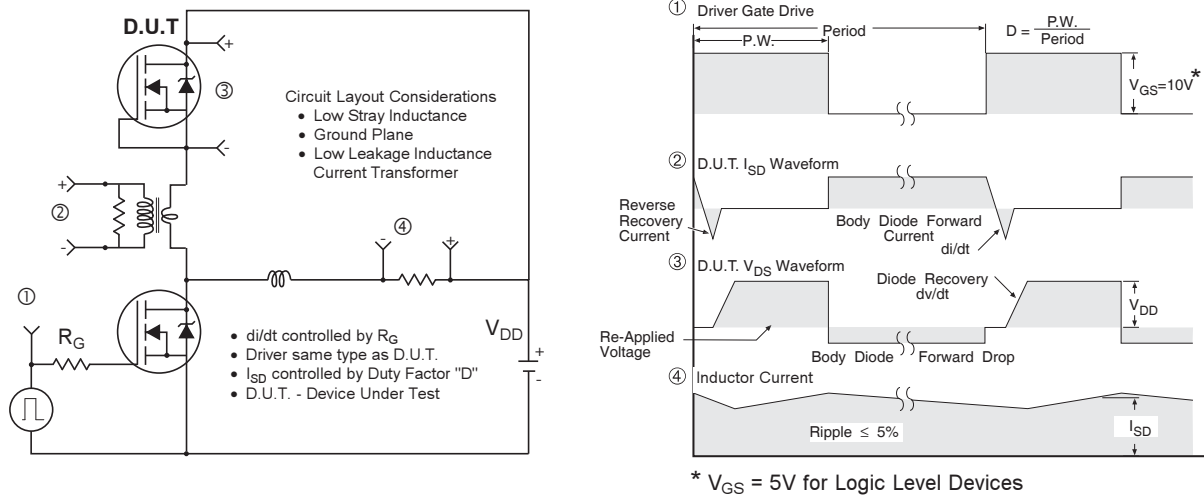

**Fig 19. Diode Reverse Recovery Test Circuit for N-Channel HEXFET® Power MOSFETs**

## DirectFET® Board Footprint, L6 (Large Size Can).

Please see AN-1035 for DirectFET assembly details and stencil and substrate design recommendations

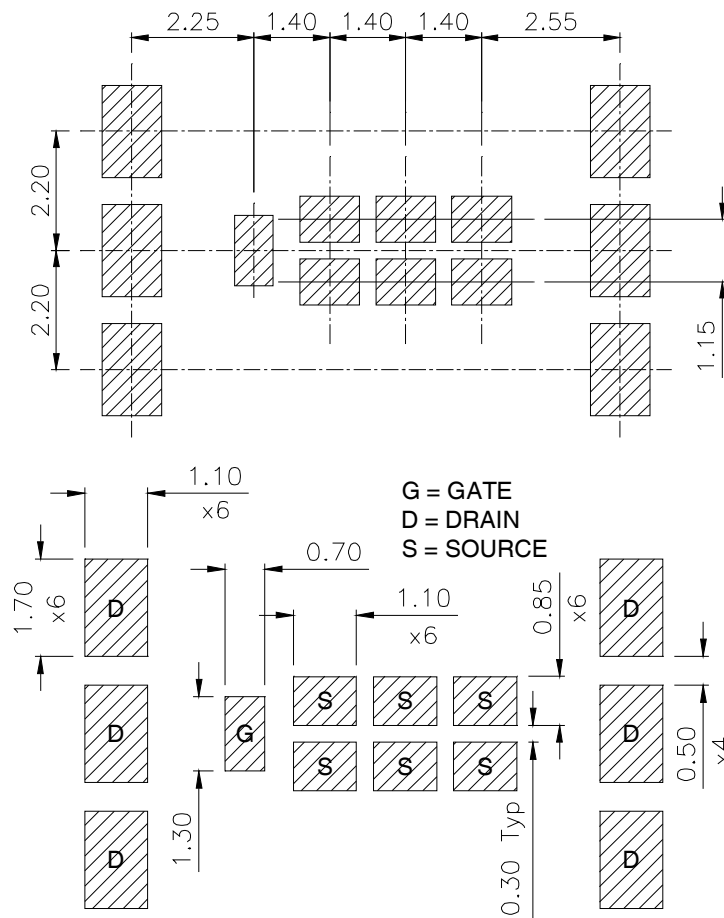



## DirectFET® Outline Dimension, L6 Outline (LargeSize Can).

Please see AN-1035 for DirectFET assembly details and stencil and substrate design recommendations

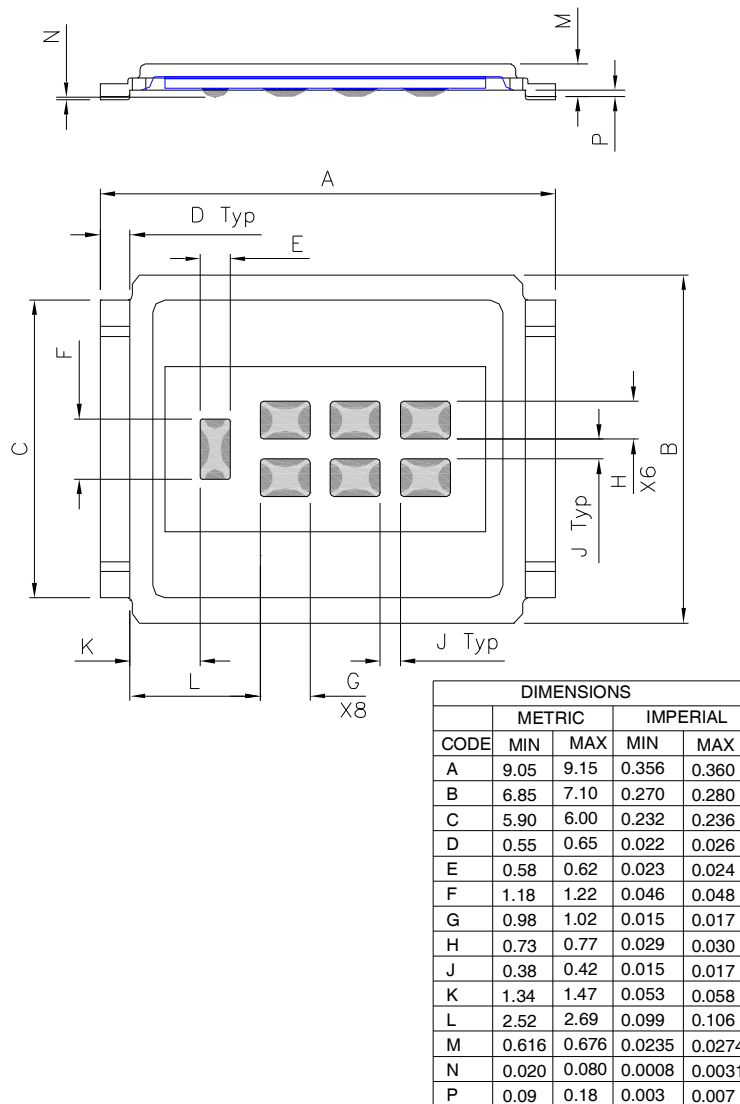

## DirectFET® Part Marking

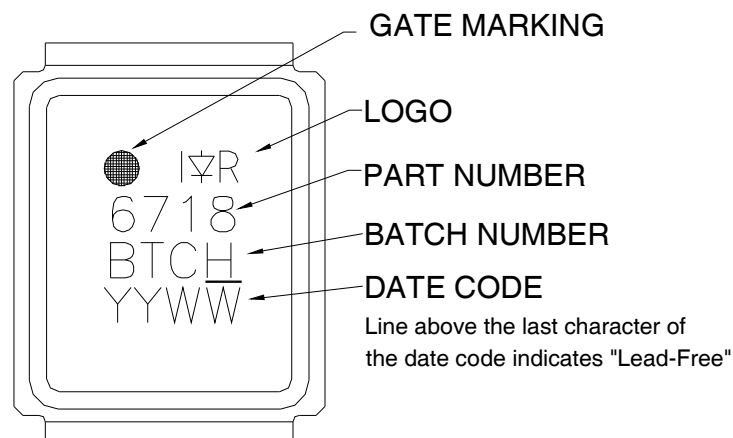

## DirectFET® Tape & Reel Dimension (Showing component orientation).

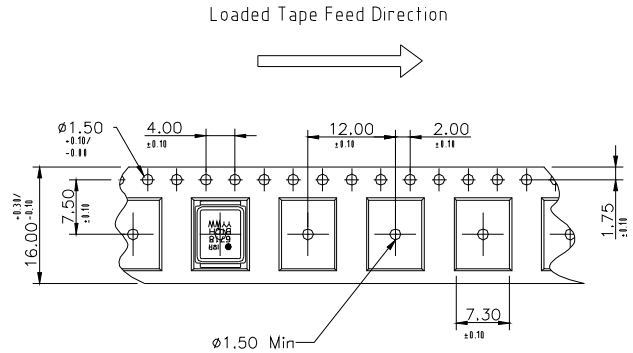
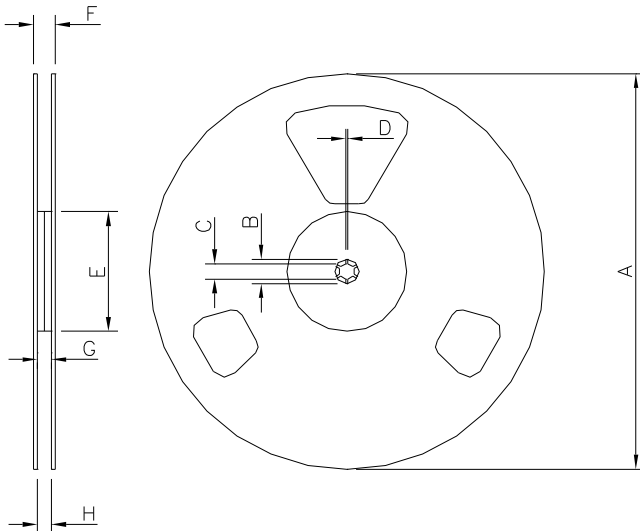

NOTE: Controlling dimensions in mm Std reel quantity is 4000 parts. (ordered as IRF6718L2PBF).

REEL DIMENSIONS				
STANDARD OPTION (QTY 4000)				
CODE	METRIC		IMPERIAL	
	MIN	MAX	MIN	MAX
A	330.0	N.C	12.992	N.C
B	20.2	N.C	0.795	N.C
C	12.8	13.2	0.504	0.520
D	1.5	N.C	0.059	N.C
E	100.0	N.C	3.937	N.C
F	N.C	22.4	N.C	0.889
G	16.4	18.4	0.646	0.724
H	15.9	18.4	0.626	0.724

NOTE: CONTROLLING DIMENSIONS IN MM

CODE	DIMENSIONS			
	METRIC		IMPERIAL	
	MIN	MAX	MIN	MAX
A	11.90	12.10	0.469	0.476
B	4.00	N/C	0.157	N/C
C	15.90	16.30	0.623	0.642
D	7.40	7.60	0.291	0.299
E	7.20	7.40	0.283	0.291
F	9.30	9.50	0.366	0.374
G	1.50	N/C	0.059	N/C
H	1.50	1.60	0.059	0.063

Note: For the most current drawing please refer to IR website at <http://www.irf.com/package>

Data and specifications subject to change without notice.

This product has been designed and qualified to MSL1 rating for the Consumer market.

Additional storage requirement details for DirectFET products can be found in application note AN1035 on IR's Web site.

Qualification Standards can be found on IR's Web site.

International  
**IR** Rectifier

IR WORLD HEADQUARTERS: 101 N. Sepulveda Blvd., El Segundo, California 90245, USA Tel: (310) 252-7105

TAC Fax: (310) 252-7903

Visit us at [www.irf.com](http://www.irf.com) for sales contact information. 07/2011