

OptiMOS[®] 2 Power-Transistor
Features

- Ideal for high-frequency dc/dc converters
- Qualified according to JEDEC¹⁾ for target applications
- N-channel, logic level
- Excellent gate charge x $R_{DS(on)}$ product (FOM)
- Superior thermal resistance
- 175 °C operating temperature
- Pb-free lead plating; RoHS compliant

Product Summary

V_{DS}	25	V
$R_{DS(on),max}$ (SMD Version)	4.2	m Ω
I_D	90	A

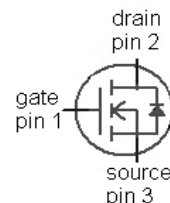

Type	IPDH4N03LA G	IPSH4N03LA G
Package	PG-TO252-3-11	PG-TO251-3-11
Ordering Code	Q67042-S4250	Q67042-S4254
Marking	H4N03LA	H4N03LA

Maximum ratings, at $T_j=25\text{ °C}$, unless otherwise specified

Parameter	Symbol	Conditions	Value	Unit
Continuous drain current	I_D	$T_C=25\text{ °C}^{2)}$	90	A
		$T_C=100\text{ °C}$	77	
Pulsed drain current	$I_{D,pulse}$	$T_C=25\text{ °C}^{3)}$	360	
Avalanche energy, single pulse	E_{AS}	$I_D=90\text{ A}$, $R_{GS}=25\ \Omega$	150	mJ
Reverse diode dv/dt	dv/dt	$I_D=90\text{ A}$, $V_{DS}=20\text{ V}$, $di/dt=200\text{ A}/\mu\text{s}$, $T_{j,max}=175\text{ °C}$	6	kV/ μs
Gate source voltage ⁴⁾	V_{GS}		± 20	V
Power dissipation	P_{tot}	$T_C=25\text{ °C}$	94	W
Operating and storage temperature	T_j, T_{stg}		-55 ... 175	°C
IEC climatic category; DIN IEC 68-1			55/175/56	

Parameter	Symbol	Conditions	Values			Unit
			min.	typ.	max.	

Thermal characteristics

Thermal resistance, junction - case	R_{thJC}		-	-	1.6	K/W
SMD version, device on PCB	R_{thJA}	minimal footprint	-	-	75	
		6 cm ² cooling area ⁵⁾	-	-	50	

Electrical characteristics, at $T_j=25\text{ °C}$, unless otherwise specified
Static characteristics

Drain-source breakdown voltage	$V_{(BR)DSS}$	$V_{GS}=0\text{ V}, I_D=1\text{ mA}$	25	-	-	V
Gate threshold voltage	$V_{GS(th)}$	$V_{DS}=V_{GS}, I_D=40\text{ }\mu\text{A}$	1.2	1.6	2	
Zero gate voltage drain current	I_{DSS}	$V_{DS}=25\text{ V}, V_{GS}=0\text{ V}, T_j=25\text{ °C}$	-	0.1	1	μA
		$V_{DS}=25\text{ V}, V_{GS}=0\text{ V}, T_j=125\text{ °C}$	-	10	100	
Gate-source leakage current	I_{GSS}	$V_{GS}=20\text{ V}, V_{DS}=0\text{ V}$	-	10	100	nA
Drain-source on-state resistance	$R_{DS(on)}$	$V_{GS}=4.5\text{ V}, I_D=50\text{ A}$	-	6.1	7.6	m Ω
		$V_{GS}=4.5\text{ V}, I_D=50\text{ A},$ SMD version	-	5.9	7.4	
		$V_{GS}=10\text{ V}, I_D=60\text{ A}$	-	3.7	4.4	
		$V_{GS}=10\text{ V}, I_D=60\text{ A},$ SMD version	-	3.5	4.2	
Gate resistance	R_G		-	1.3	-	Ω
Transconductance	g_{fs}	$ V_{DS} >2 I_D R_{DS(on)max},$ $I_D=60\text{ A}$	45	90	-	S

¹⁾ J-STD20 and JESD22

¹⁾ Current is limited by bondwire; with an $R_{thJC}=1.6\text{ K/W}$ the chip is able to carry 109 A.

³⁾ See figure 3

⁴⁾ $T_{j,max}=150\text{ °C}$ and duty cycle $D<0.25$ for $V_{GS}<-5\text{ V}$

⁵⁾ Device on 40 mm x 40 mm x 1.5 mm epoxy PCB FR4 with 6 cm² (one layer, 70 μm thick) copper area for drain connection. PCB is vertical in still air.

Parameter	Symbol	Conditions	Values			Unit
			min.	typ.	max.	

Dynamic characteristics

Input capacitance	C_{iss}	$V_{GS}=0\text{ V}, V_{DS}=15\text{ V},$ $f=1\text{ MHz}$	-	2400	3200	pF
Output capacitance	C_{oss}		-	920	1200	
Reverse transfer capacitance	C_{rss}		-	110	160	
Turn-on delay time	$t_{d(on)}$	$V_{DD}=15\text{ V}, V_{GS}=10\text{ V},$ $I_D=25\text{ A}, R_G=2.7\ \Omega$	-	9	14	ns
Rise time	t_r		-	7	11	
Turn-off delay time	$t_{d(off)}$		-	29	44	
Fall time	t_f		-	4.6	7	

Gate Charge Characteristics⁶⁾

Gate to source charge	Q_{gs}	$V_{DD}=15\text{ V}, I_D=45\text{ A},$ $V_{GS}=0\text{ to }5\text{ V}$	-	8	11	nC
Gate charge at threshold	$Q_{g(th)}$		-	3.9	5.1	
Gate to drain charge	Q_{gd}		-	5.6	8	
Switching charge	Q_{sw}		-	10	14	
Gate charge total	Q_g		-	19	26	
Gate plateau voltage	$V_{plateau}$		-	3.4	-	
Gate charge total, sync. FET	$Q_{g(sync)}$	$V_{DS}=0.1\text{ V},$ $V_{GS}=0\text{ to }5\text{ V}$	-	17	23	nC
Output charge	Q_{oss}	$V_{DD}=15\text{ V}, V_{GS}=0\text{ V}$	-	20	27	

Reverse Diode

Diode continuous forward current	I_S	$T_C=25\text{ }^\circ\text{C}$	-	-	78	A
Diode pulse current	$I_{S,pulse}$		-	-	360	
Diode forward voltage	V_{SD}	$V_{GS}=0\text{ V}, I_F=78\text{ A},$ $T_j=25\text{ }^\circ\text{C}$	-	0.93	1.2	V
Reverse recovery charge	Q_{rr}	$V_R=15\text{ V}, I_F=I_S,$ $di_F/dt=400\text{ A}/\mu\text{s}$	-	-	15	nC

⁶⁾ See figure 16 for gate charge parameter definition

1 Power dissipation

$$P_{tot} = f(T_C)$$

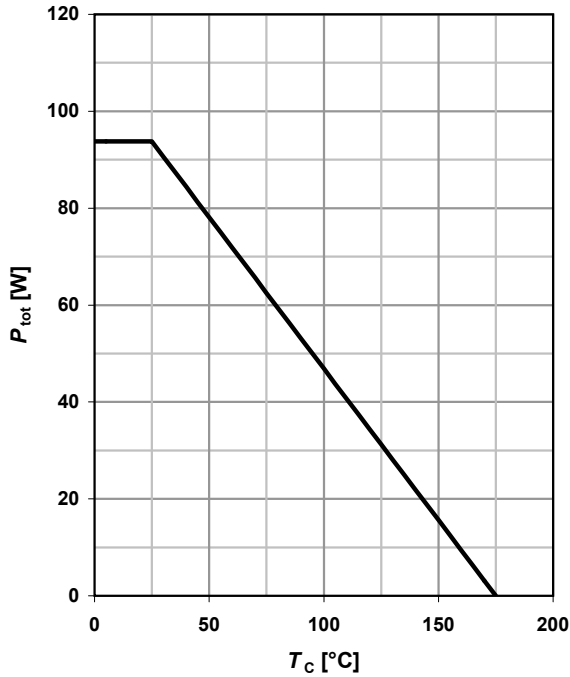

2 Drain current

$$I_D = f(T_C); V_{GS} \geq 10 \text{ V}$$

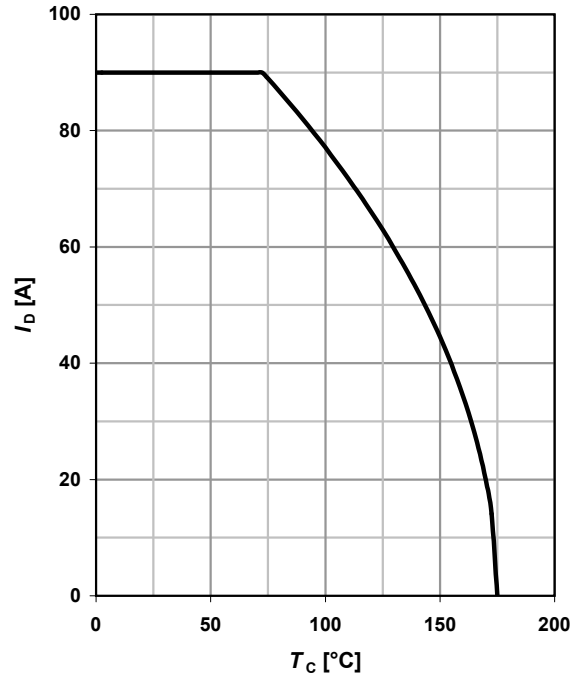

3 Safe operating area

$$I_D = f(V_{DS}); T_C = 25 \text{ °C}; D = 0$$

parameter: t_p

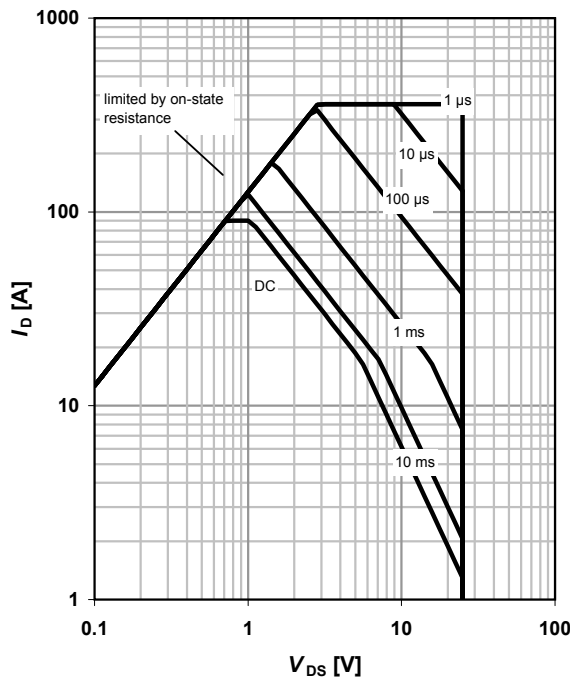

4 Max. transient thermal impedance

$$Z_{thJC} = f(t_p)$$

parameter: $D = t_p / T$

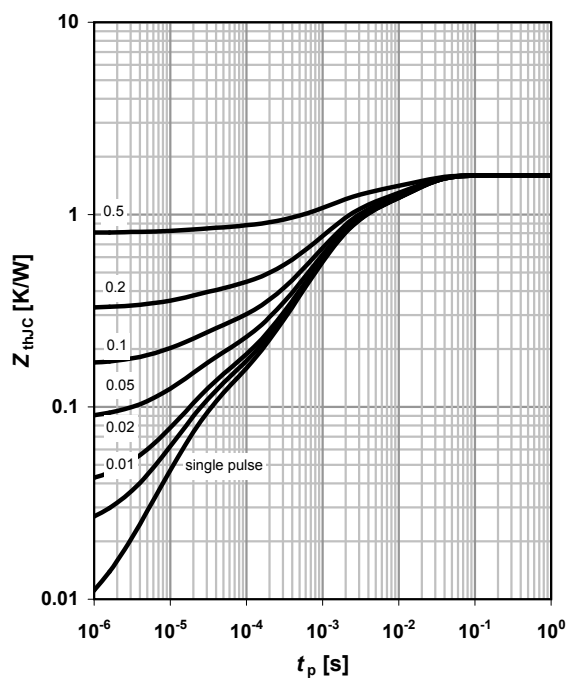

5 Typ. output characteristics

$I_D = f(V_{DS}); T_j = 25\text{ }^\circ\text{C}$

parameter: V_{GS}

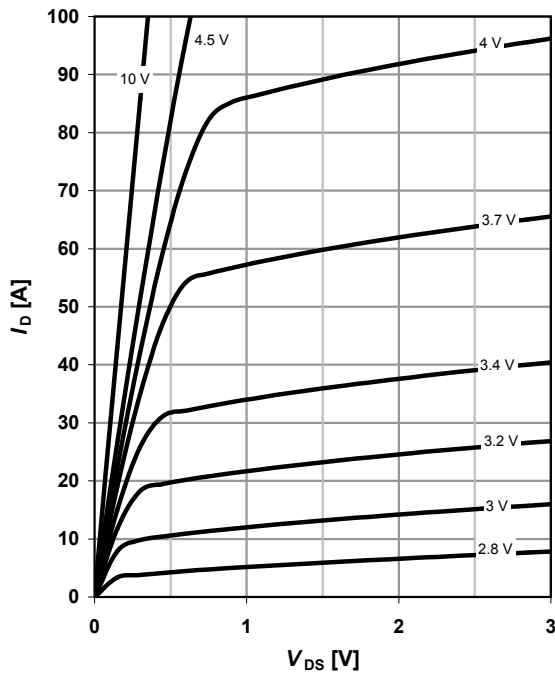

6 Typ. drain-source on resistance

$R_{DS(on)} = f(I_D); T_j = 25\text{ }^\circ\text{C}$

parameter: V_{GS}

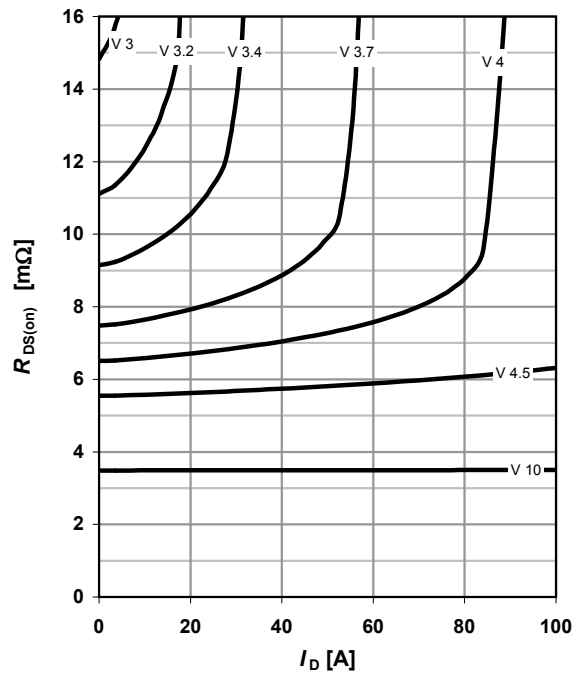

7 Typ. transfer characteristics

$I_D = f(V_{GS}); |V_{DS}| > 2|I_D|R_{DS(on)max}$

parameter: T_j

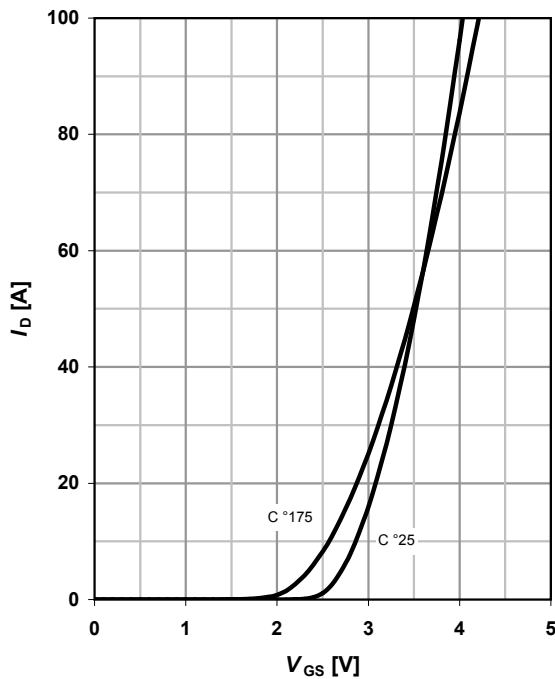

8 Typ. forward transconductance

$g_{fs} = f(I_D); T_j = 25\text{ }^\circ\text{C}$

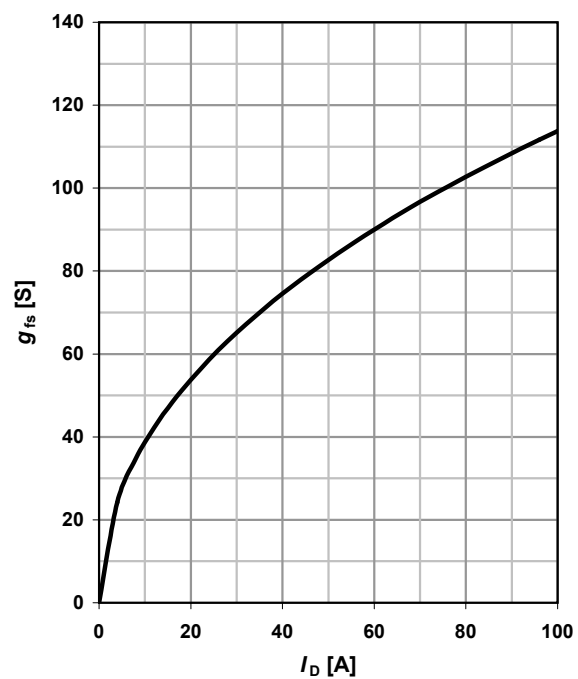

9 Drain-source on-state resistance

$R_{DS(on)} = f(T_j); I_D = 60 \text{ A}; V_{GS} = 10 \text{ V}$

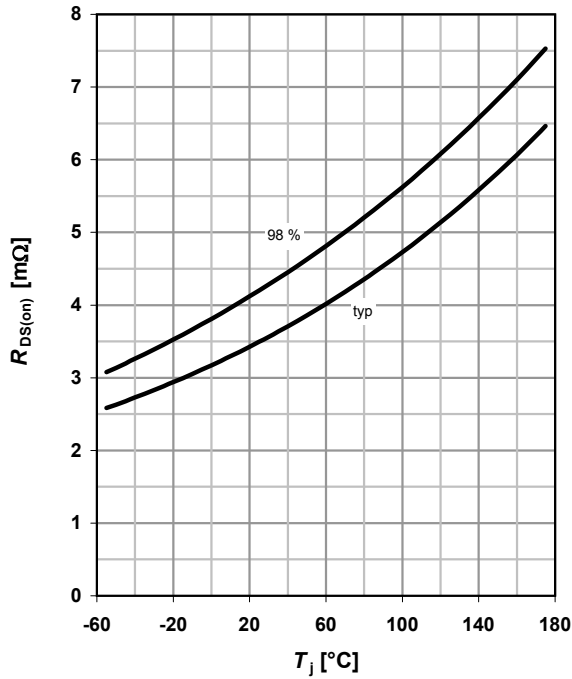

10 Typ. gate threshold voltage

$V_{GS(th)} = f(T_j); V_{GS} = V_{DS}$

parameter: I_D

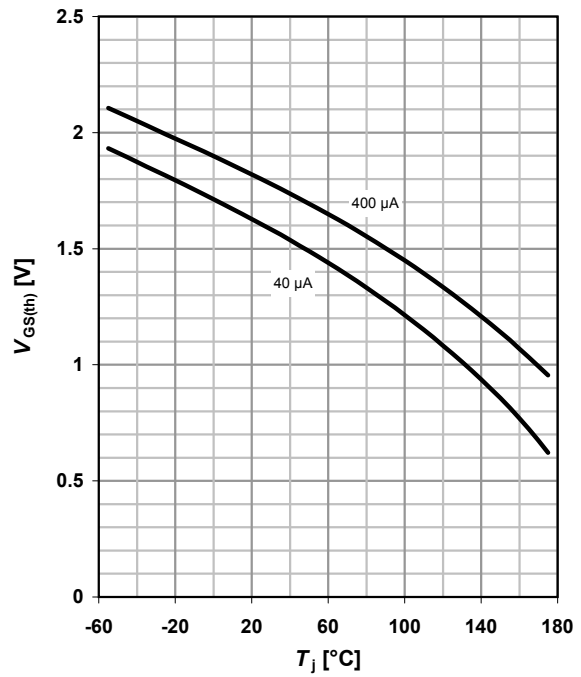

11 Typ. capacitances

$C = f(V_{DS}); V_{GS} = 0 \text{ V}; f = 1 \text{ MHz}$

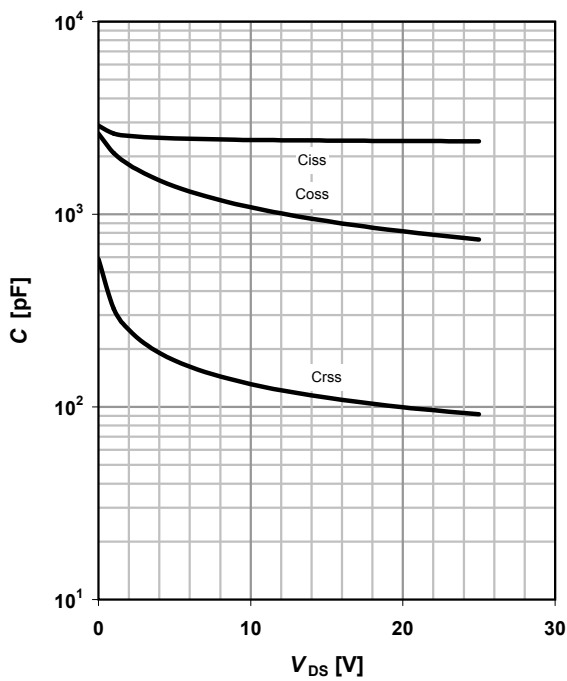

12 Forward characteristics of reverse diode

$I_F = f(V_{SD})$

parameter: T_j

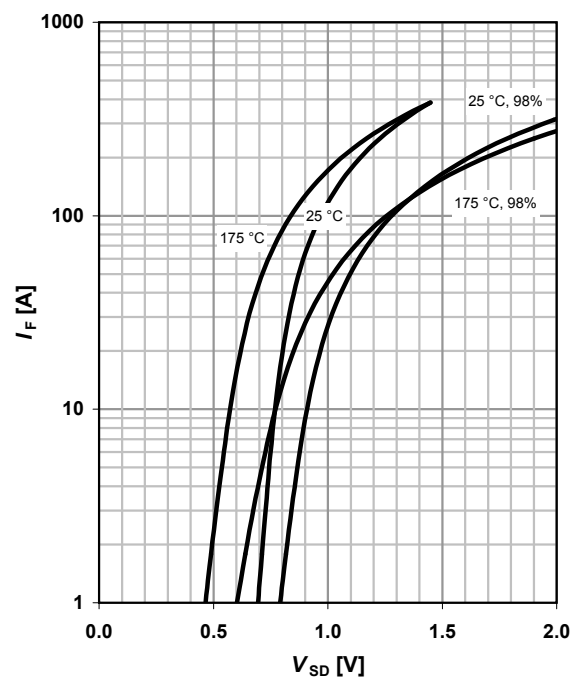

13 Avalanche characteristics

$I_{AS}=f(t_{AV}); R_{GS}=25 \Omega$

parameter: $T_{j(start)}$

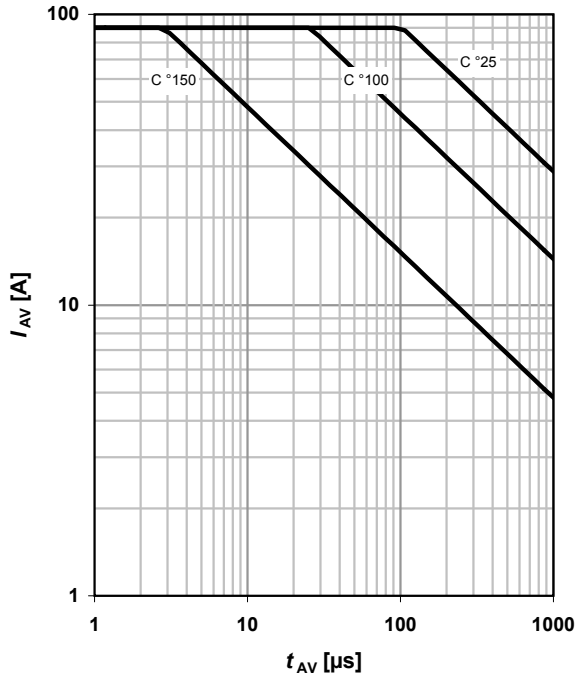

14 Typ. gate charge

$V_{GS}=f(Q_{gate}); I_D=45 \text{ A pulsed}$

parameter: V_{DD}

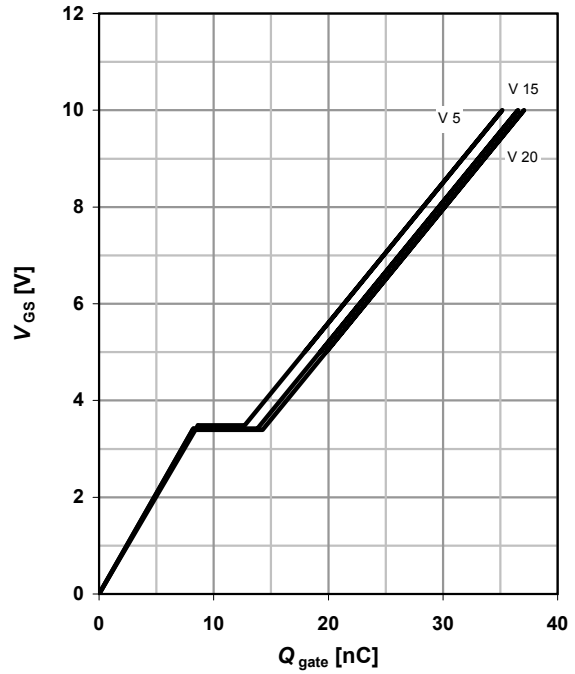

15 Drain-source breakdown voltage

$V_{BR(DSS)}=f(T_j); I_D=1 \text{ mA}$

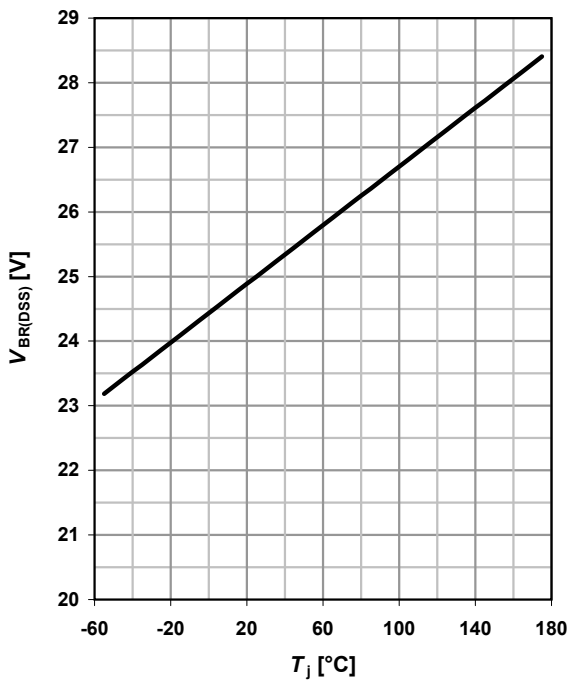

16 Gate charge waveforms



Package Outline

PG-TO252-3-11: Outline

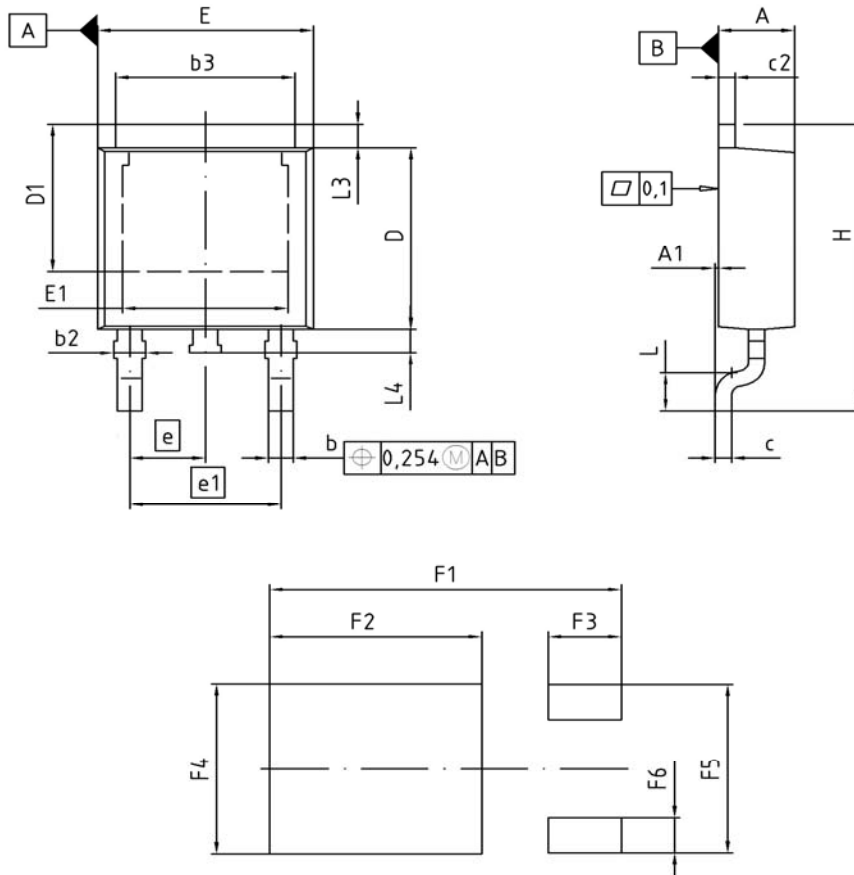

DIM	MILLIMETERS		INCHES	
	MIN	MAX	MIN	MAX
A	2.16	2.41	0.085	0.095
A1	0.00	0.15	0.000	0.006
b	0.64	0.89	0.025	0.035
b2	0.65	1.15	0.026	0.045
b3	5.00	5.50	0.197	0.217
c	0.46	0.60	0.018	0.024
c2	0.46	0.98	0.018	0.039
D	5.97	6.22	0.235	0.245
D1	5.02	5.84	0.198	0.230
E	6.40	6.73	0.252	0.265
E1	4.70	5.21	0.185	0.205
e	2.29		0.090	
e1	4.57		0.180	
N	3		3	
H	9.40	10.48	0.370	0.413
L	1.18	1.70	0.046	0.067
L3	0.90	1.25	0.035	0.049
L4	0.51	1.00	0.020	0.039
F1	10.50	10.70	0.413	0.421
F2	6.30	6.50	0.248	0.256
F3	2.10	2.30	0.083	0.091
F4	5.70	5.90	0.224	0.232
F5	5.66	5.86	0.223	0.231
F6	1.10	1.30	0.043	0.051

DOCUMENT NO.
Z8B00003328

SCALE

EUROPEAN PROJECTION

ISSUE DATE
19-10-2007

REVISION
03

Package Outline

PG-TO251-3-11: Outline

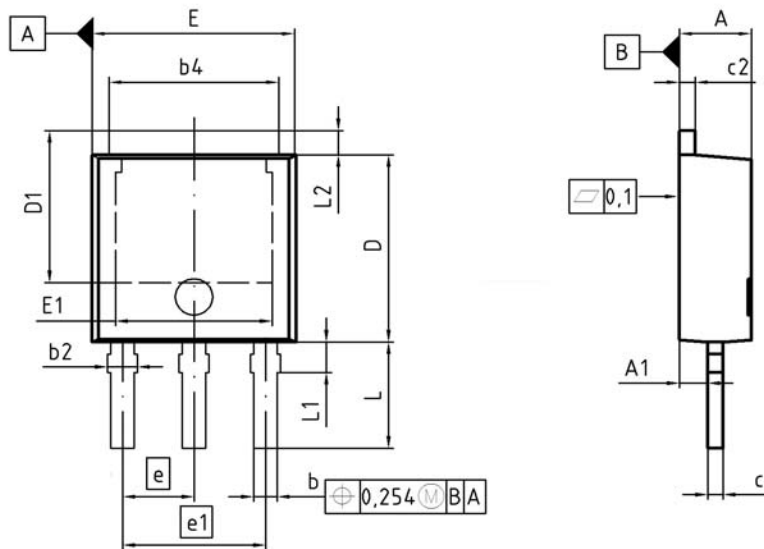

DIM	MILLIMETERS		INCHES	
	MIN	MAX	MIN	MAX
A	2.18	2.39	0.086	0.094
A1	0.80	1.14	0.031	0.045
b	0.64	0.89	0.025	0.035
b2	0.65	1.15	0.026	0.045
b4	4.95	5.50	0.195	0.217
c	0.46	0.58	0.018	0.023
c2	0.46	0.89	0.018	0.035
D	5.97	6.22	0.235	0.245
D1	5.04	5.44	0.198	0.214
E	6.35	6.73	0.250	0.265
E1	4.90	5.10	0.193	0.201
e	2.29		0.090	
e1	4.57		0.180	
N	3		3	
L	3.40	3.60	0.134	0.142
L1	0.90	1.10	0.035	0.043
L2	0.90	1.10	0.035	0.043

DOCUMENT NO.
Z8B00003329

SCALE

EUROPEAN PROJECTION

ISSUE DATE
17-01-2008

REVISION
03

Published by
Infineon Technologies AG
81726 Munich, Germany
© 2008 Infineon Technologies AG
All Rights Reserved.

Legal Disclaimer

The information given in this document shall in no event be regarded as a guarantee of conditions or characteristics. With respect to any examples or hints given herein, any typical values stated herein and/or any information regarding the application of the device, Infineon Technologies hereby disclaims any and all warranties and liabilities of any kind, including without limitation, warranties of non-infringement of intellectual property rights of any third party.

Information

For further information on technology, delivery terms and conditions and prices, please [contact the nearest Infineon Technologies Office \(www.infineon.com\)](http://www.infineon.com).

Warnings

Due to technical requirements, components may contain dangerous substances. For information on the types in question, please contact the nearest Infineon Technologies Office.

Infineon Technologies components may be used in life-support devices or systems only with the express written approval of Infineon Technologies, if a failure of such components can reasonably be expected to cause the failure of that life-support device or system or to affect the safety or effectiveness of that device or system. Life support devices or systems are intended to be implanted in the human body or to support and/or maintain and sustain and/or protect human life. If they fail, it is reasonable to assume that the health of the user or other persons may be endangered.