

GAAS PHEMT MMIC LOW NOISE AMPLIFIER, 18 - 32 GHz

Typical Applications

The HMC519 is ideal for use as either a LNA or driver amplifier for:

- Point-to-Point Radios
- Point-to-Multi-Point Radios & VSAT
- Test Equipment & Sensors
- Military & Space

Functional Diagram

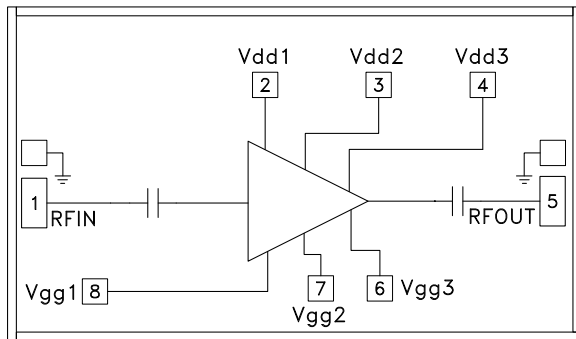

Features

- Noise Figure: 2.8 dB
- Gain: 15 dB
- OIP3: 23 dBm
- Single Supply: +3V @ 65 mA
- 50 Ohm Matched Input/Output
- Die Size: 2.27 x 1.32 x 0.1 mm

General Description

The HMC519 chip is a high dynamic range GaAs PHEMT MMIC Low Noise Amplifier (LNA) which covers the 18 to 32 GHz frequency range. The HMC519 provides 15 dB of small signal gain, 2.8 dB of noise figure and has an output IP3 greater than 23 dBm. The chip can easily be integrated into hybrid or MCM assemblies due to its small size. All data is tested with the chip in a 50 Ohm test fixture connected via 0.075 mm (3 mil) ribbon bonds of minimal length 0.31 mm (12 mil). Two 0.025 mm (1 mil) diameter bondwires may also be used to make the RFIN and RFOUT connections.

Electrical Specifications, $T_A = +25^\circ\text{C}$, Vdd 1, 2, 3 = +3V

Parameter	Min.	Typ.	Max.	Min.	Typ.	Max.	Units
Frequency Range	18 - 28		28 - 32				GHz
Gain	12	15		11	14		dB
Gain Variation Over Temperature		0.015	0.025		0.015	0.025	dB/ °C
Noise Figure		2.8	3.5		3.5	4.5	dB
Input Return Loss		13			9		dB
Output Return Loss		12			12		dB
Output Power for 1 dB Compression (P1dB)	9	12		10	14		dBm
Saturated Output Power (Psat)		15			18		dBm
Output Third Order Intercept (IP3)		23			26		dBm
Supply Current (Idd)(Vdd = +3V)		65	88		65	88	mA

GAAS PHEMT MMIC LOW NOISE AMPLIFIER, 18 - 32 GHz

Broadband Gain & Return Loss

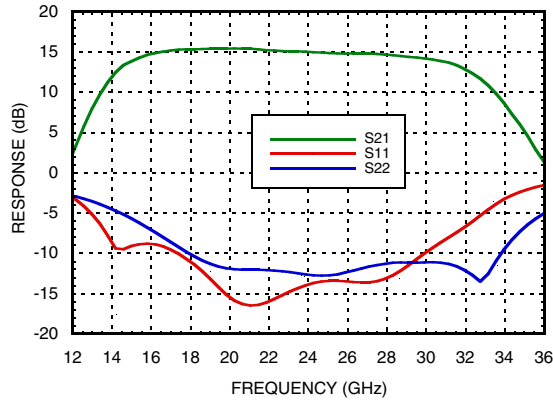

Gain vs. Temperature

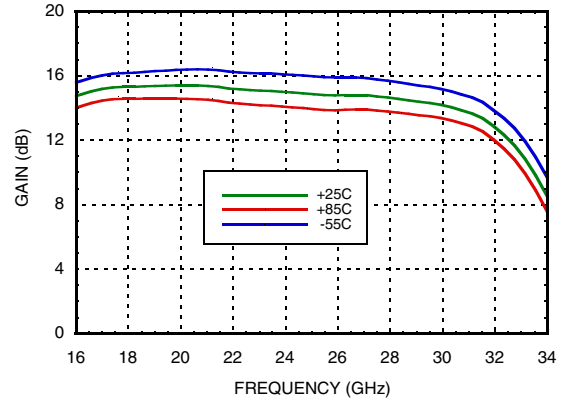

Input Return Loss vs. Temperature

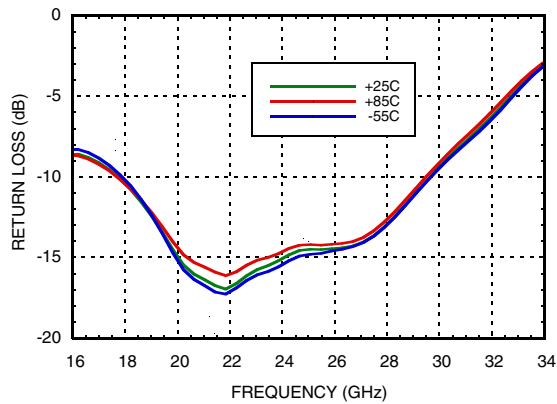

Output Return Loss vs. Temperature

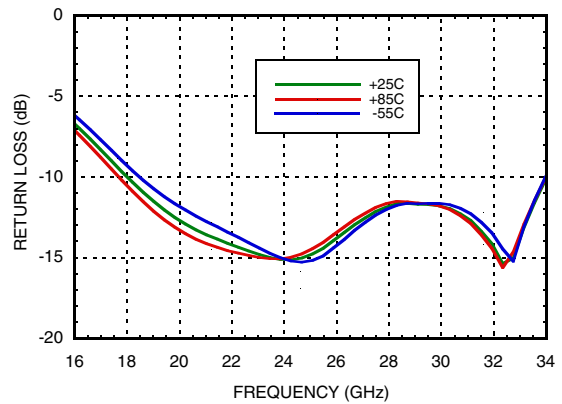

Noise Figure vs. Temperature

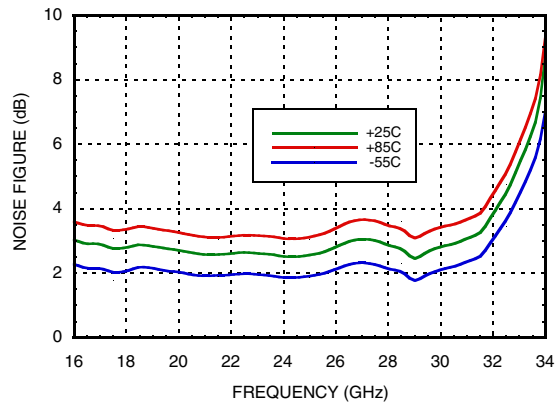

Output IP3 vs. Temperature

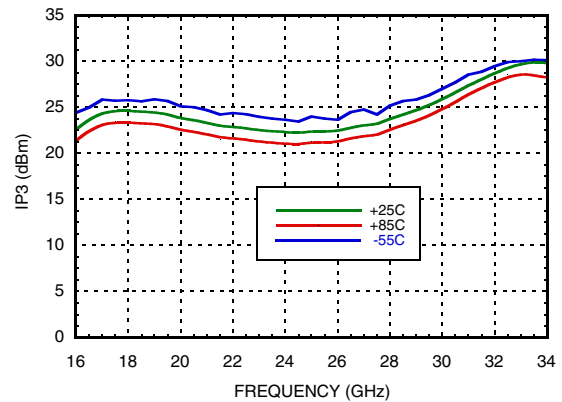

GAAS PHEMT MMIC LOW NOISE AMPLIFIER, 18 - 32 GHz

P1dB vs. Temperature

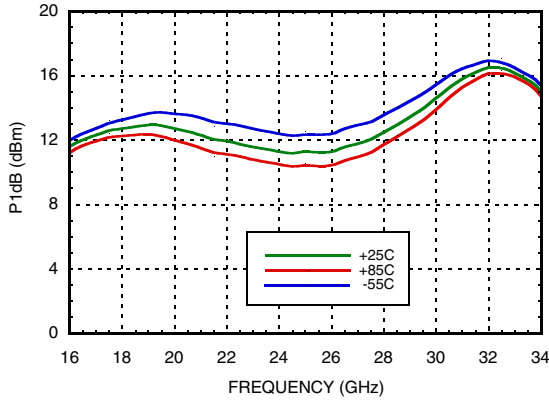

Psat vs. Temperature

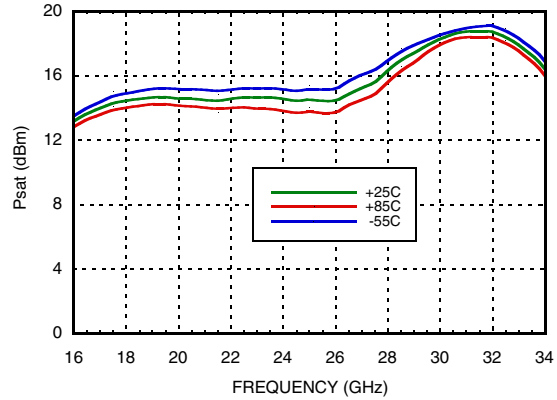

Reverse Isolation vs. Temperature

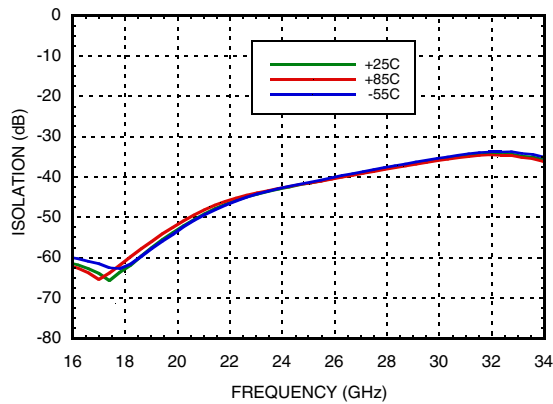

Power Compression @ 24 GHz

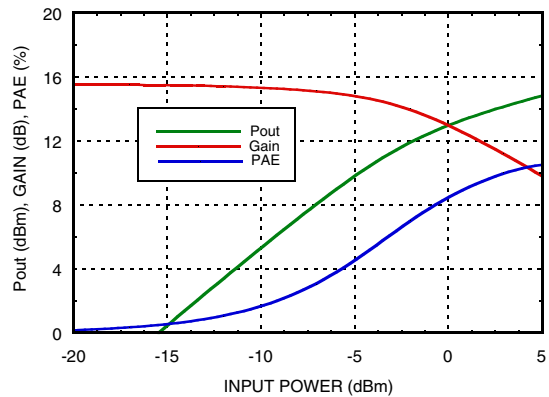

Gain, Noise Figure & Power vs. Supply Voltage @ 24 GHz

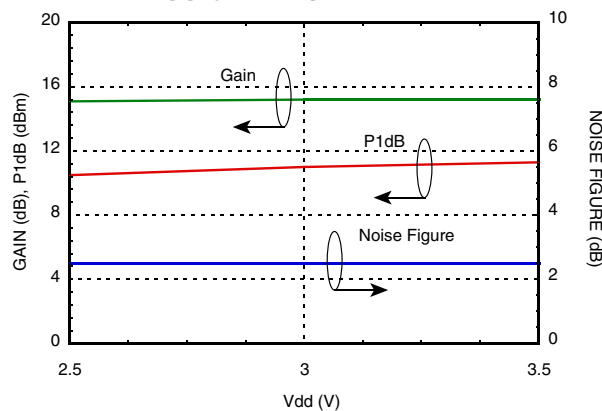

Additive Phase Noise Vs Offset Frequency, RF Frequency = 26.5 GHz, RF Input Power = 4 dBm (Psat)

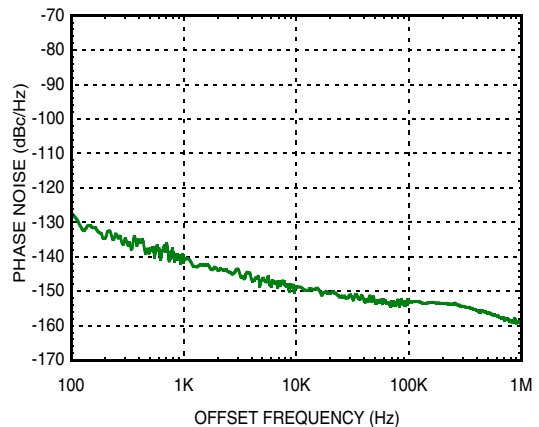

GAAS PHEMT MMIC LOW NOISE AMPLIFIER, 18 - 32 GHz

Absolute Maximum Ratings

Drain Bias Voltage (Vdd1, Vdd2, Vdd3)	+5.5 Vdc
RF Input Power (RFIN)(Vdd = +3.0 Vdc)	+20 dBm
Channel Temperature	175 °C
Continuous Pdiss (T= 85 °C) (derate 18 mW/°C above 85 °C)	1.65 W
Thermal Resistance (channel to die bottom)	54.6 °C/W
Storage Temperature	-65 to +150 °C
Operating Temperature	-55 to +85 °C
ESD Sensitivity (HBM)	Class 1A

Typical Supply Current vs. Vdd

Vdd (Vdc)	Idd (mA)
+2.5	61
+3.0	65
+3.5	69

Note: Amplifier will operate over full voltage ranges shown above.



ELECTROSTATIC SENSITIVE DEVICE
OBSERVE HANDLING PRECAUTIONS

Outline Drawing

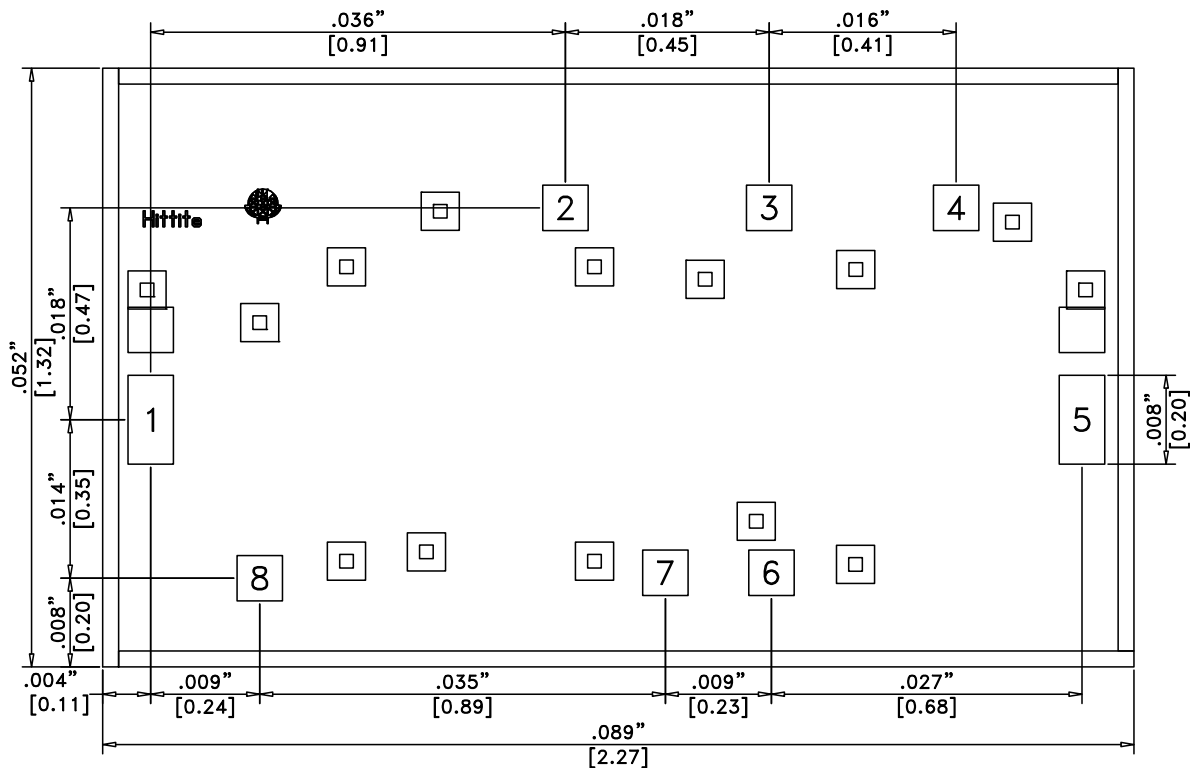

Die Packaging Information ^[1]

Standard	Alternate
GP-2 (Gel Pack)	[2]

[1] Refer to the "Packaging Information" section for die packaging dimensions.

[2] For alternate packaging information contact Hittite Microwave Corporation.

NOTES:

- ALL DIMENSIONS ARE IN INCHES [MM]
- DIE THICKNESS IS .004"
- TYPICAL BOND IS .004" SQUARE
- BACKSIDE METALLIZATION: GOLD
- BOND PAD METALLIZATION: GOLD
- BACKSIDE METAL IS GROUND.
- CONNECTION NOT REQUIRED FOR UNLABELED BOND PADS.

GAAS PHEMT MMIC LOW NOISE AMPLIFIER, 18 - 32 GHz

Pad Descriptions

Pad Number	Function	Description	Interface Schematic
1	RFIN	This pad is AC coupled and matched to 50 Ohms.	RFIN ○ — —
2, 3, 4	Vdd1, 2, 3	Power Supply Voltage for the amplifier. External bypass capacitors of 100 pF and 0.1 μF are required.	○ Vdd1,2,3
5	RFOUT	This pad is AC coupled and matched to 50 Ohms.	— — ○ RFOUT
6, 7, 8	Vgg3, Vgg2, Vgg1	These pads must be connected to RF/DC ground for proper operation.	
Die Bottom	GND	Die Bottom must be connected to RF/DC ground.	○ GND

Assembly Diagram

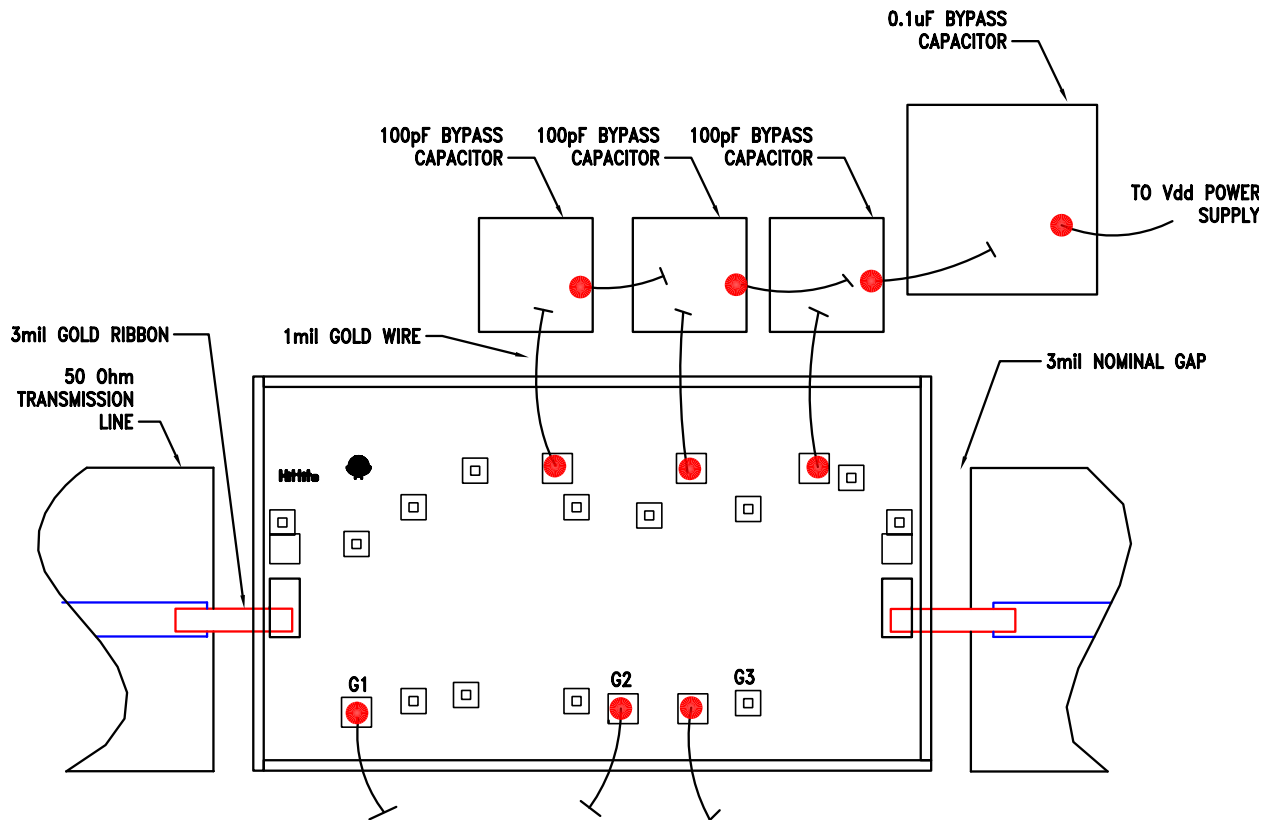

Note: Vgg1, Vgg2 and Vgg3 must be connected to RF/DC ground.

GAAS PHEMT MMIC LOW NOISE AMPLIFIER, 18 - 32 GHz

Mounting & Bonding Techniques for Millimeterwave GaAs MMICs

The die should be attached directly to the ground plane eutectically or with conductive epoxy (see *HMC general Handling, Mounting, Bonding Note*).

50 Ohm Microstrip transmission lines on 0.127mm (5 mil) thick alumina thin film substrates are recommended for bringing RF to and from the chip (Figure 1). If 0.254mm (10 mil) thick alumina thin film substrates must be used, the die should be raised 0.150mm (6 mils) so that the surface of the die is coplanar with the surface of the substrate. One way to accomplish this is to attach the 0.102mm (4 mil) thick die to a 0.150mm (6 mil) thick molybdenum heat spreader (moly-tab) which is then attached to the ground plane (Figure 2).

Microstrip substrates should be brought as close to the die as possible in order to minimize bond wire length. Typical die-to-substrate spacing is 0.076mm to 0.152 mm (3 to 6 mils). Gold ribbon of 0.075 mm (3 mils) width and minimum < 0.31 mm (<12 mils) is recommended.

Handling Precautions

Follow these precautions to avoid permanent damage.

Storage: All bare die are placed in either Waffle or Gel based ESD protective containers, and then sealed in an ESD protective bag for shipment. Once the sealed ESD protective bag has been opened, all die should be stored in a dry nitrogen environment.

Cleanliness: Handle the chips in a clean environment. DO NOT attempt to clean the chip using liquid cleaning systems.

Static Sensitivity: Follow ESD precautions to protect against ESD strikes.

Transients: Suppress instrument and bias supply transients while bias is applied. Use shielded signal and bias cables to minimize inductive pick-up.

General Handling: Handle the chip along the edges with a vacuum collet or with a sharp pair of bent tweezers. The surface of the chip has fragile air bridges and should not be touched with vacuum collet, tweezers, or fingers.

Mounting

The chip is back-metallized and can be die mounted with AuSn eutectic preforms or with electrically conductive epoxy. The mounting surface should be clean and flat.

Eutectic Die Attach: A 80/20 gold tin preform is recommended with a work surface temperature of 255 °C and a tool temperature of 265 °C. When hot 90/10 nitrogen/hydrogen gas is applied, tool tip temperature should be 290 °C. DO NOT expose the chip to a temperature greater than 320 °C for more than 20 seconds. No more than 3 seconds of scrubbing should be required for attachment.

Epoxy Die Attach: Apply a minimum amount of epoxy to the mounting surface so that a thin epoxy fillet is observed around the perimeter of the chip once it is placed into position. Cure epoxy per the manufacturer's schedule.

Wire Bonding

RF bonds made with 0.003" x 0.0005" ribbon are recommended. These bonds should be thermosonically bonded with a force of 40-60 grams. DC bonds of 0.001" (0.025 mm) diameter, thermosonically bonded, are recommended. Ball bonds should be made with a force of 40-50 grams and wedge bonds at 18-22 grams. All bonds should be made with a nominal stage temperature of 150 °C. A minimum amount of ultrasonic energy should be applied to achieve reliable bonds. All bonds should be as short as possible, less than 12 mils (0.31 mm).

