

SUMMARY

Wires

Low	2
High	0
Coax	0
Triax	0
Quad	0
Fiber	0
Fluidic	0

Series	1E
Termination type	Male solder
IP rating	68
Cable Ø	2.60 - 3.00 mm
Matching parts	ERA.1E.302.CLL
Status	active
Alternative part	



Image is for illustrative purpose only

Download

[Request a quote](#)

[Catalog](#)

TECHNICAL DETAILS

Mechanics

Shell Style/Model	FFA*: Straight plug, cable collet and nut for fitting a bend relief
Keying	Hermaphroditic keying ("half moon" insert), plug has male pin 1
Housing Material	Brass (chrome plated) shell and collet nut, nickel plated brass latch sleeve and mid pieces
Cable Fixing	C30: 2.6 - 3 mm
Variant	Z : Nut for fitting a bend relief
Weight	23.90 g

Performance

Configuration	1E.302 : 2 Low Voltage
Insulator	L: PEEK (UL 94 / V-0/3.2, depends on material thickness)
Rated Current	15 Amps

Specifications

Contact Type: Solder
Max. Matings: 5000

LEMO products and services are provided "as is". LEMO makes no warranties or representations with regard to LEMO product & services or use of them, express, implied or statutory, including for accuracy, completeness, or security. The user is fully responsible for his products and applications using LEMO components.

Contact Dia.: 1.3 mm (0.051in)
 Bucket Dia.: 1 mm (0.039in)
 Max. Solid Conductor: 0.5 mm² (AWG 20)
 Max. Stranded Conductor: 0.5 mm² (AWG 20)
 R (max): 3.6 mOhm
 Vtest: 1200 V (AC), 1700 V (DC)

Others

Endurance (Shell): 5000 mating cycles
 Temp (min / max): -55°C / +200°C
 Humidity (max): <=95% [at 60 deg C / 140 F]
 Vibration: 15 g [10 Hz - 2000 Hz]
 Shock Resistance: 100 g [6 ms]
 Salt Spray Corrosion: >1000 hr
 Climatical Category: 50/175/21
 Shielding (min): 95 dB (10 MHz)
 Shielding (min): 80 dB (1 GHz)
 IP Rating: 68

DRAWINGS

Draws

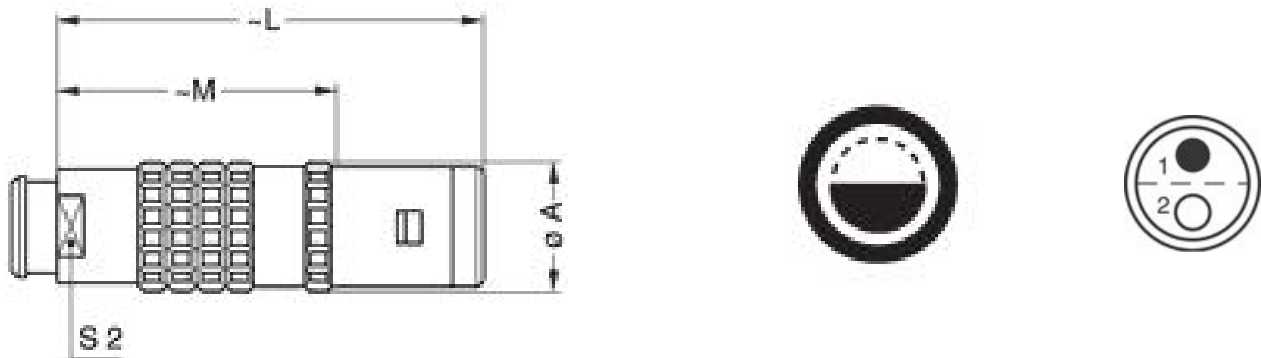

Dimensions

	A	L	M	S2
mm.	13	42	28	9
in.	0,51	1,65	1,10	0,35

LEMO products and services are provided "as is". LEMO makes no warranties or representations with regard to LEMO product & services or use of them, express, implied or statutory, including for accuracy, completeness, or security. The user is fully responsible for his products and applications using LEMO components.







RECOMMENDED BY LEMO

Tools

Spanner wrench: DCD.1E.008.PA090

Caps: BFA.1E.100.NAS

Cables

CMN.02.T28.030PGCE	PVC	GREY	
CMN.02.T28.030PGZE		Grey	
CMN.02.T28.030PNCE	PVC	Black	
CMN.02.T28.030PNZE			
002 050	PVC	Black	
002 260	PTFE	White	

LEMO products and services are provided "as is". LEMO makes no warranties or representations with regard to LEMO product & services or use of them, express, implied or statutory, including for accuracy, completeness, or security. The user is fully responsible for his products and applications using LEMO components.