

SUMMARY

Wires

Low	14
High	0
Coax	0
Triax	0
Quad	0
Fiber	0
Fluidic	0



Image is for illustrative purpose only

Download

[Request a quote](#)

[Catalog](#)

Series	2W
Termination type	Female solder
IP rating	68
Cable Ø	0.00 - 0.00 mm
Matching parts	FVG.2W.314.CLAC50
Status	active
Alternative part	

TECHNICAL DETAILS

Mechanics

Shell Style/Model	EV*: Fixed socket, nut fixing
Keying	1 key (alpha=0; Plug: male contacts; Receptacle: female contacts)
Housing Material	Brass (chrome plated) shell and collet nut, nickel plated brass latch sleeve and mid pieces
Cable Fixing	∅ 0 - 0 mm
Variant	
Weight	24.75 g

Performance

Configuration	
Insulator	
Rated Current	6.5 Amps

Specifications

Contact Type:	Solder
Max. Matings:	5000
Contact Dia.:	0.7 mm (0.028in)

LEMO products and services are provided "as is". LEMO makes no warranties or representations with regard to LEMO product & services or use of them, express, implied or statutory, including for accuracy, completeness, or security. The user is fully responsible for his products and applications using LEMO components.

Bucket Dia.: 0.8 mm (0.031in)
 Max. Solid Conductor: 0.34 mm² (AWG 22)
 Max. Stranded Conductor: 0.34 mm² (AWG 22)
 R (max): 6.1 mOhm
 Vtest (contact-contact): 1150 V (AC) 1600 V (DC)
 Vtest (contact-shell): 1350 V (AC) 1900 V (DC)

Others

Pressure: 30 bars
 IP Rating: 68

DRAWINGS

Draws

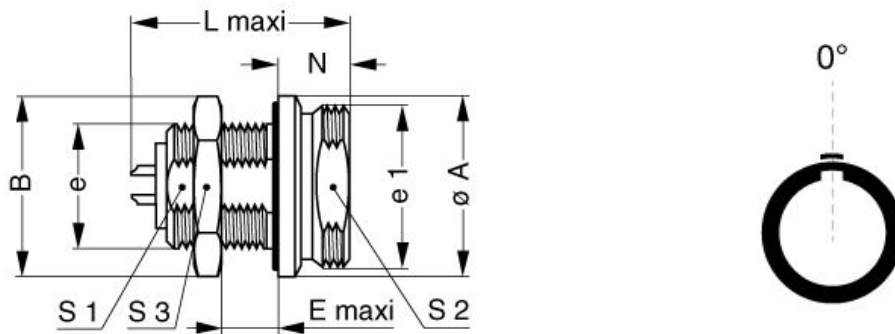

Dimensions

	A	B	E	L	N	S1	S2	S3	e	e1
mm.	22.5	21.8	9	30.7	9	14.5	18.5	19	M16x1.0	M20x1.0
in.	0,89	0,86	0,35	1,21	0,35	0,57	0,73	0,75		















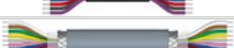

RECOMMENDED BY LEMO

Tools

None

Cables

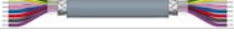
LEMO products and services are provided "as is". LEMO makes no warranties or representations with regard to LEMO product & services or use of them, express, implied or statutory, including for accuracy, completeness, or security. The user is fully responsible for his products and applications using LEMO components.

CMN.14.T22.068PGCE	PVC	GREY	
CMN.14.T22.068PGZE		Grey	
CMN.14.T22.068PNCE	PVC	Black	
CMN.14.T22.068PNZE			
CMN.14.T22.081PGCE	PVC	GREY	
CMN.14.T22.081PGZE		Grey	
CMN.14.T22.081PNCE	PVC	Black	
CMN.14.T22.081PNZE			
CMN.14.T28.056PGCE	PVC	GREY	
CMN.14.T28.056PGZE		Grey	
CMN.14.T28.056PNCE	PVC	Black	
CMN.14.T28.056PNZE			
CMN.14.T28.056QGZE	TPR (medical)	Grey	
114 260	PTFE	White	
214 140	PVC	Black	
214 240	PTFE	White	
314 250	PVC	Grey	

LEMO products and services are provided "as is". LEMO makes no warranties or representations with regard to LEMO product & services or use of them, express, implied or statutory, including for accuracy, completeness, or security. The user is fully responsible for his products and applications using LEMO components.