

SUMMARY



Image is for illustrative purpose only

Wires

Low	2
High	0
Coax	0
Triax	0
Quad	0
Fiber	0
Fluidic	0

Download

[Request a quote](#)

[Catalog](#)

Series	0W
Termination type	Female solder
IP rating	68
Cable Ø	0.00 - 0.00 mm
Matching parts	FVG.0W.302.CLAC50Z
Status	active
Alternative part	

TECHNICAL DETAILS

Mechanics

Shell Style/Model	EV*: Fixed socket, nut fixing
Keying	1 key (alpha=0; Plug: male contacts; Receptacle: female contacts)
Housing Material	Brass (chrome plated) shell and collet nut, nickel plated brass latch sleeve and mid pieces
Cable Fixing	∅ 0 - 0 mm
Variant	
Weight	10.54 g

Performance

Configuration	
Insulator	
Rated Current	#10 Amps

Specifications

Contact Type: Solder
Max. Matings: 5000
Contact Dia.: 0.9 mm (0.035in)

LEMO products and services are provided "as is". LEMO makes no warranties or representations with regard to LEMO product & services or use of them, express, implied or statutory, including for accuracy, completeness, or security. The user is fully responsible for his products and applications using LEMO components.

Bucket Dia.: 0.8 mm (0.031in)
 Max. Solid Conductor: 0.34 mm² (AWG 22)
 Max. Stranded Conductor: 0.34 mm² (AWG 22)
 R (max): 4.8 mOhm
 Vtest (contact-contact): 1300 V (AC) 1800 V (DC)
 Vtest (contact-shell): 1050 V (AC) 1500 V (DC)

Others

Pressure: 30 bars
 IP Rating: 68

DRAWINGS

Draws

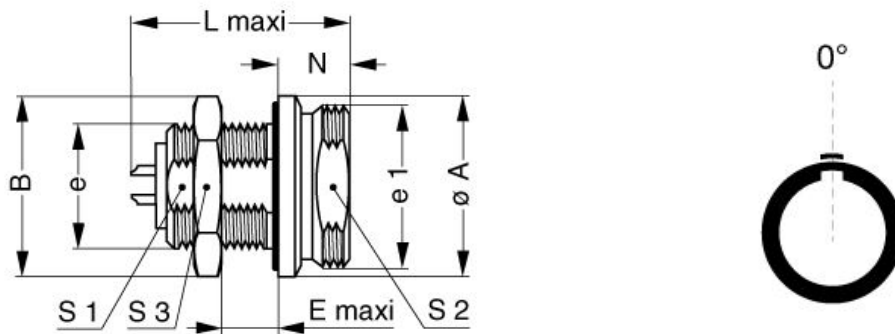

Dimensions

	A	B	E	L	N	S1	S2	S3	e	e1
mm.	16.2	16	4	21.7	8	10.5	12.5	14	M12x1.0	M14x1.0
in.	0,64	0,63	0,16	0,85	0,31	0,41	0,49	0,55		





























RECOMMENDED BY LEMO

Tools

None

Cables

LEMO products and services are provided "as is". LEMO makes no warranties or representations with regard to LEMO product & services or use of them, express, implied or statutory, including for accuracy, completeness, or security. The user is fully responsible for his products and applications using LEMO components.

CMN.02.T22.047PGCE	PVC	GREY	
CMN.02.T22.047PGZE		Grey	
CMN.02.T22.047PNCE	PVC	Black	
CMN.02.T22.047PNZE			
CMN.02.T28.030PGCE	PVC	GREY	
CMN.02.T28.030PGZE		Grey	
CMN.02.T28.030PNCE	PVC	Black	
CMN.02.T28.030PNZE			
002 050	PVC	Black	
002 080	PVC	Grey	
002 221	PVC	Black	
002 260	PTFE	White	
002 280	PVC	Black	
004 082	PVC	Grey	
020 140	PVC	Grey	
020 140	PVC	Grey	
020 141	PVC	Grey	
020 142	PVC	Red	
020 143	PVC	Green	
020 144	PVC	Black	
020 145	PVC	Yellow	
020 146	PVC	Black	
020 240	PTFE	White	
020 260	PVC	Black	
020 264	PVC	Black	
020 266	PVC	Violet	
020 550	PUR	Black	
020 560	PUR	White	
102 080	PVC	Grey	
120 184	PVC	Black	
120 240	PVC	Black	
120 250	PVC	Grey	
CCX.50.RG1.74U30B	TFE	White	
CMB.02.210.635	PUR	Black	

LEMO products and services are provided "as is". LEMO makes no warranties or representations with regard to LEMO product & services or use of them, express, implied or statutory, including for accuracy, completeness, or security. The user is fully responsible for his products and applications using LEMO components.