



SERIES: ETSA 60W UD | **DESCRIPTION:** AC-DC POWER SUPPLY

FEATURES

- 60 W power
- universal input (90~264 Vac)
- single regulated output from 12~48V
- over voltage and short circuit protections
- UL/cUL and TUV safety approvals
- level V efficiency
- custom designs available



MODEL	output voltage (Vdc)	output current max (A)	output power max (W)	ripple and noise ¹ max (mVp-p)	efficiency level
ETSA120500UD	12	5.0	60	150	V
ETSA190342UD	19	3.42	60	190	V
ETSA240270UD	24	2.70	60	240	V
ETSA480125UD	48	1.25	60	190	V

Notes: 1. At full load, 100 ~ 240 Vac input, 20 MHz bandwidth oscilloscope, each output terminated with 10 μ F aluminum electrolytic and 0.1 μ F ceramic capacitors.

PART NUMBER KEY

ETSA120500UD X - XX - SZ - CXX

Base Number
example of 12 Vdc, 5 A

AC Input Plug:
D = IEC 320 C8 plug

Input Cable:
"Blank" = No Cable
C = North American input cable
2 = European input cable
3 = United Kingdom input cable
4 = Australian input cable
5 = China input cable
6 = South Korea input cable
7 = Brazil input cable
8 = South Africa input cable
9 = Japan input cable

DC Plug type:
see output plug options
on page 7

Factory Designation

Reserved for Custom Configurations

INPUT

parameter	conditions/description	min	typ	max	units
voltage		90		264	Vac
frequency		47		63	Hz
inrush current	12 V model all other models			1.4 1.5	A A
leakage current				0.25	mA
no load power consumption	12 V model all other models			0.5 0.3	W W

OUTPUT

parameter	conditions/description	min	typ	max	units
line regulation			±1		%
load regulation			±5		%

PROTECTIONS

parameter	conditions/description	min	typ	max	units
over voltage protection	24 V model 19, 48 V models			36 32	Vdc Vdc
short circuit protection	output shut down and auto restart				

SAFETY & COMPLIANCE

parameter	conditions/description	min	typ	max	units
isolation voltage	input to output at 10 mA for 1 minute			3,000 4,242	Vac Vdc
isolation resistance	input to output at 500 V dc	100			MΩ
safety approvals	UL/cUL (UL 60950-1), CE, EN 60950-1/IEC 60950-1				
EMI/EMC	FCC part 15, subpart b, class B; CE; CISPR 22, class B; ICES-003; VCCI; EN 61204-3; EN 55022; EN 55024; EN 61000-(2, 3); IEC 61000-4-(2, 3, 4, 5, 6, 8, 11)				
RoHS	2011/65/EU				

ENVIRONMENTAL

parameter	conditions/description	min	typ	max	units
operating temperature		0		40	°C
storage temperature		-10		70	°C
operating humidity		20		80	%
storage humidity		10		90	%

MECHANICAL

parameter	conditions/description	min	typ	max	units
dimensions	4.567 x 1.969 x 1.220 (116 x 50 x 31 mm)				inch
input plug	IEC320 / C8				

MECHANICAL DRAWING

units: mm
tolerance: ± 1 mm

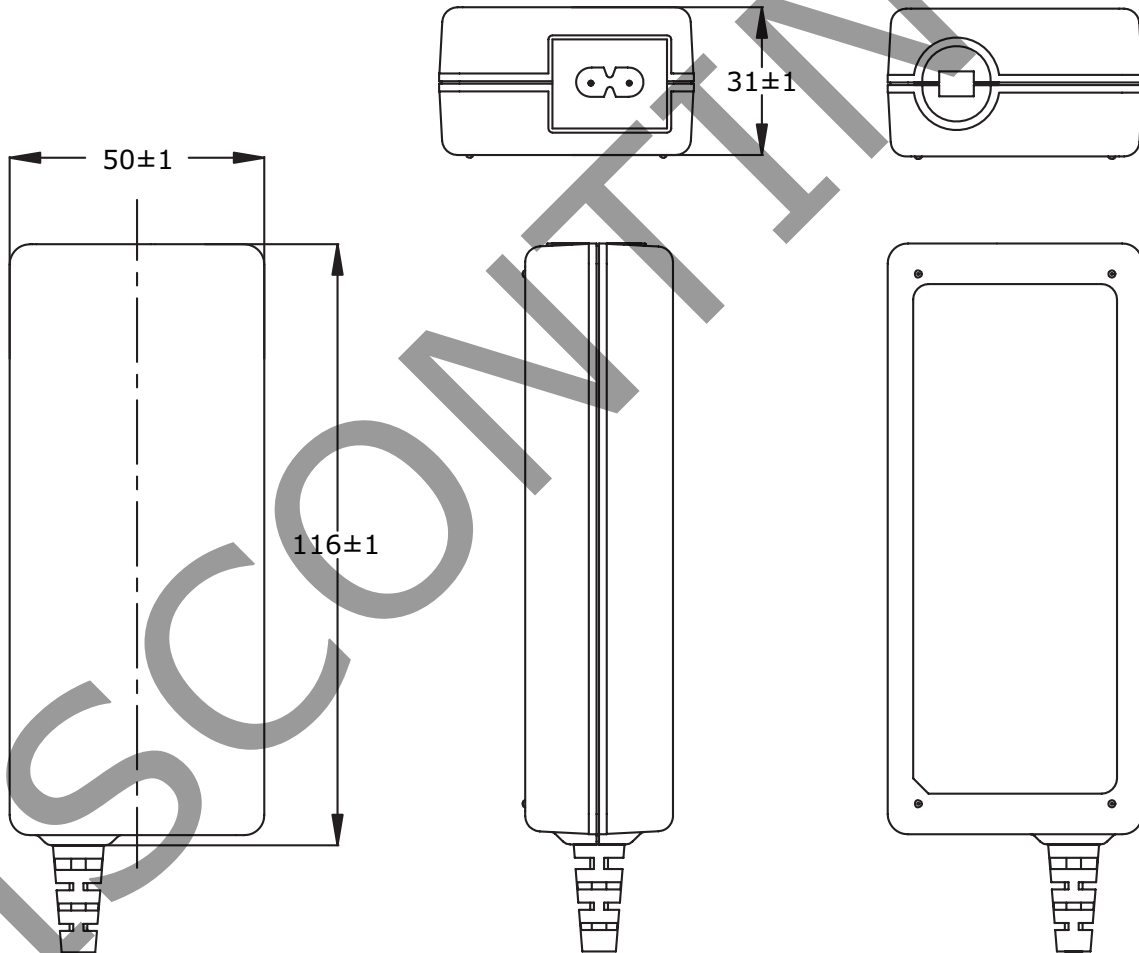

DC CORD

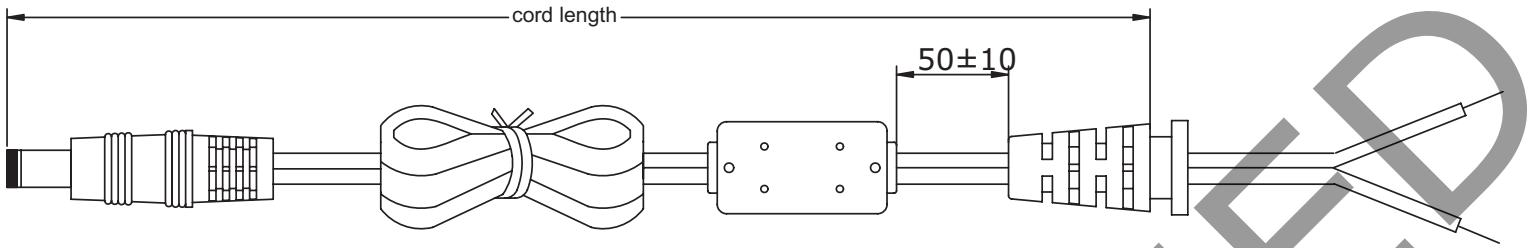

MODEL NO.	CABLE GAUGE	CORD LENGTH
ETSA120500UD	16 AWG	1,000 ±100
ETSA190342UD	18 AWG	1,830 +150/-0
ETSA240270UD	18 AWG	1,530 ±100
ETSA480125UD	18 AWG	1,830 +150/-0

AC CORD

NORTH AMERICAN INPUT CABLE

units: mm

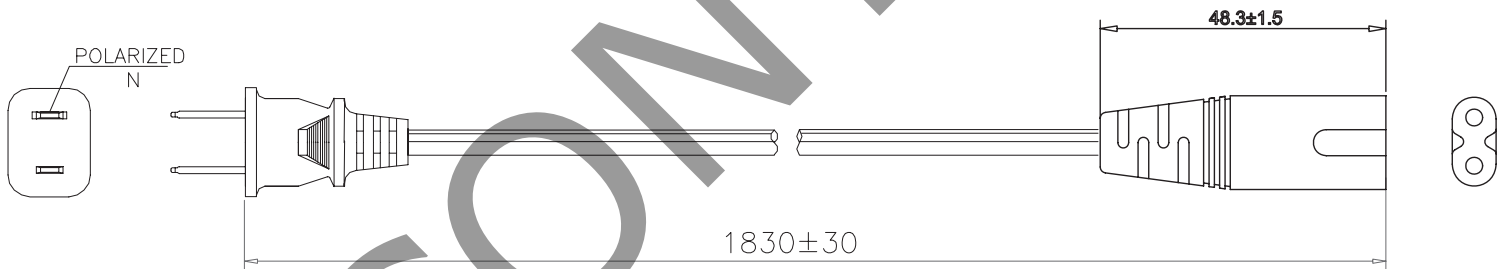

EUROPEAN INPUT CABLE

units: mm

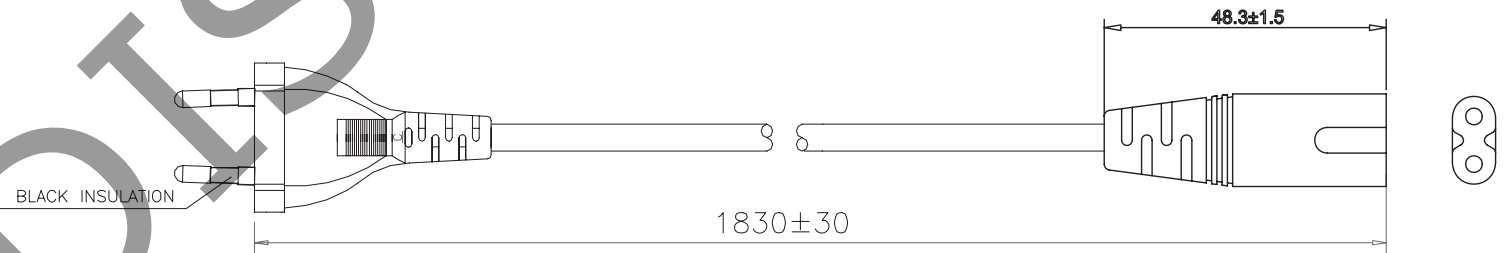

AC CORD (CONTINUED)

UNITED KINGDOM INPUT CABLE

units: mm

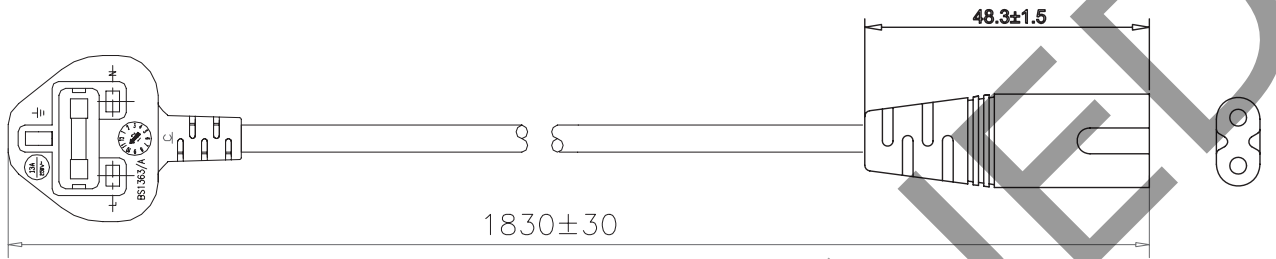

AUSTRALIAN INPUT CABLE

units: mm

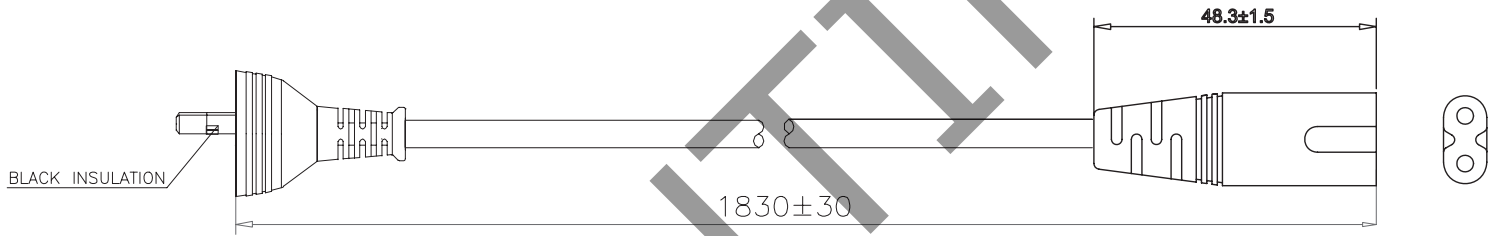

CHINA INPUT CABLE

units: mm

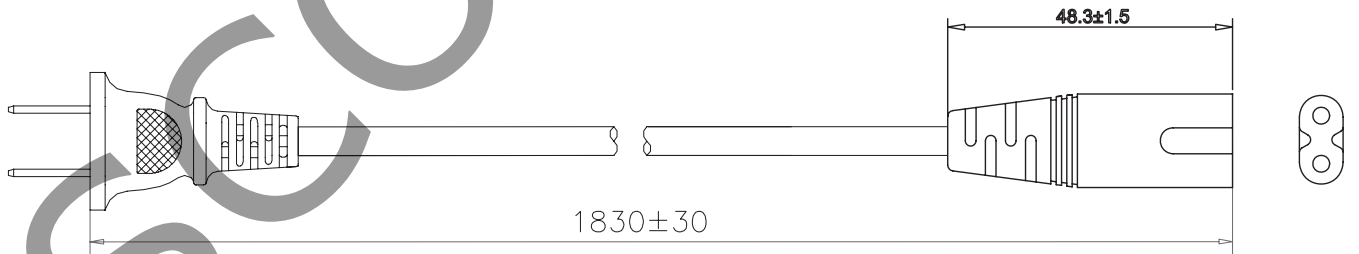

SOUTH KOREA INPUT CABLE

units: mm

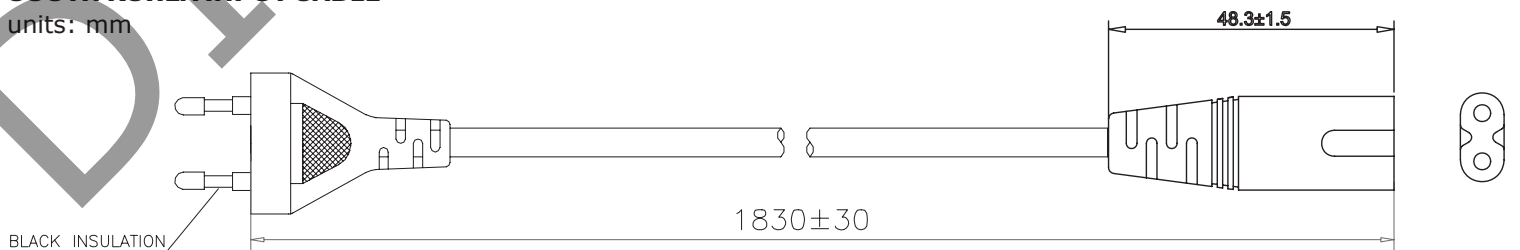

AC CORD (CONTINUED)

BRAZIL INPUT CABLE

units: mm

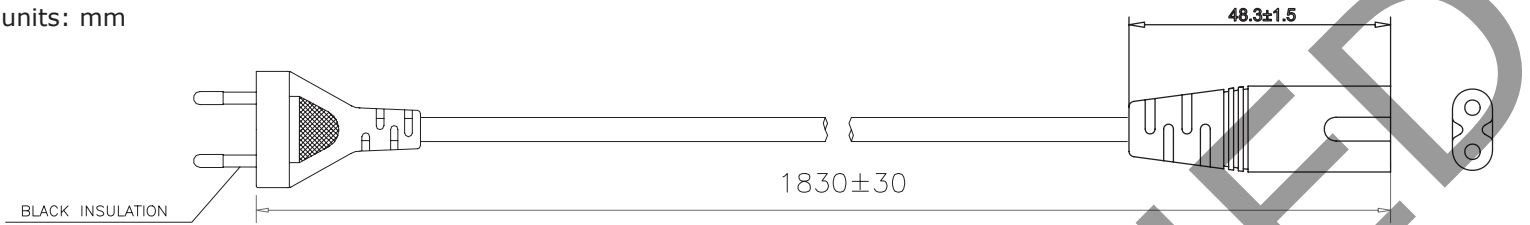

SOUTH AFRICA INPUT CABLE

units: mm

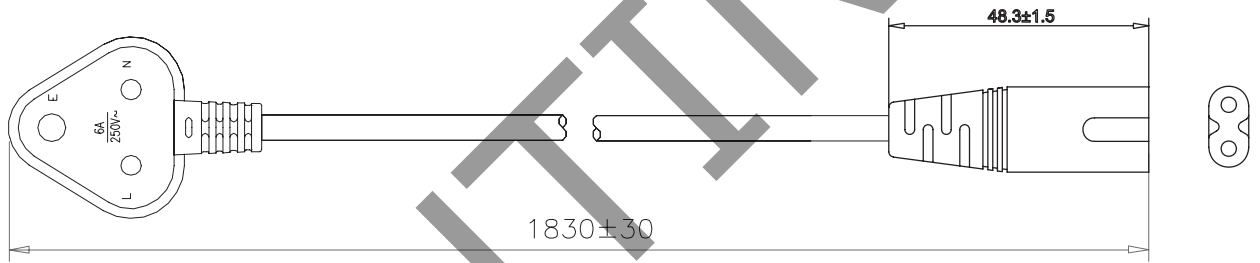

JAPAN INPUT CABLE

units: mm

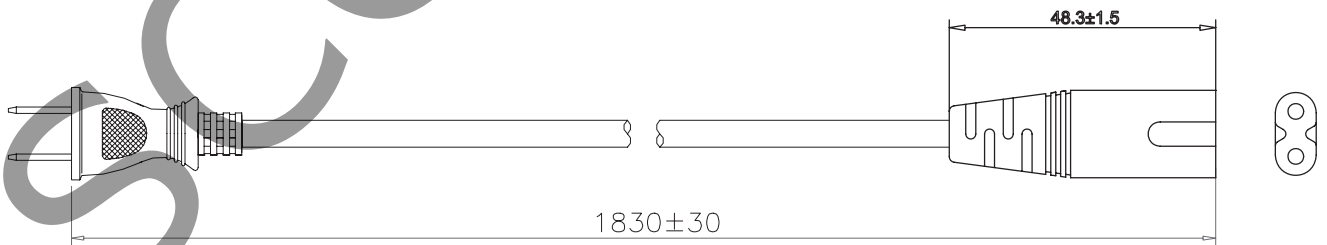

OUTPUT PLUG OPTIONS

3.5 mm Phono Plug

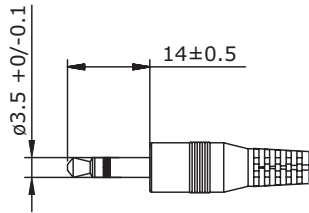

P1

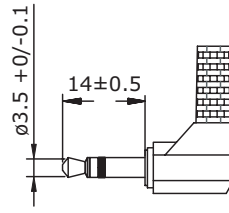

P1R

*Tip positive

Standard DC Plug

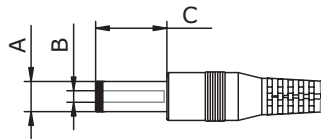

Standard PX

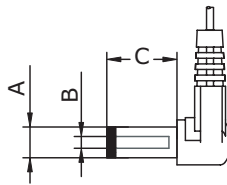

Right Angle PXR

	A	B	C	Unit
P5/P5R	5.5	2.1	9.5	mm
P6/P6R	5.5	2.5	9.5	mm
P7/P7R	3.5	1.35	9.5	mm
P8/P8R	3.8	1.35	9.5	mm
P9/P9R	3.8	1.05	9.5	mm

Locking DC Plug

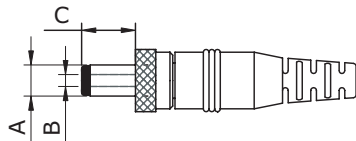

	A	B	C	Unit
P10	5.5	2.1	9.5	mm
P11	5.5	2.5	9.5	mm

EIAJ Plugs

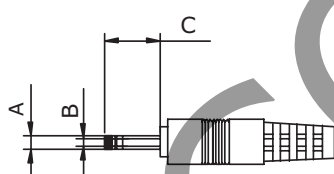

Standard PXX

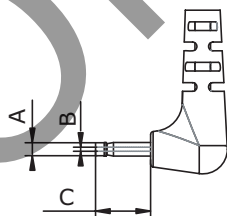

Right Angle PXXR

	EIAJ	A	B	C	D	Unit
P12/P12R	EIAJ-1	2.35	0.7	9.5	NA	mm
P13/P13R	EIAJ-2	4.0	1.7	9.5	5.0	mm
P14/P14R	EIAJ-3	4.75	1.7	9.5	5.0	mm

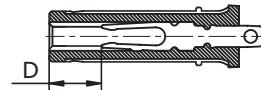

Stripped and Tinned

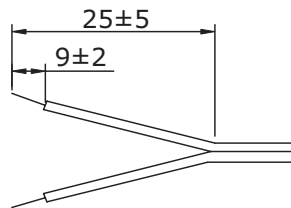

DC PLUG TYPE

PXX XX

Plug Type:
PXX = See above plug options
ST = Stripped and Tinned

Plug Angle:
"blank" = Straight
R = Right Angle

Plug Polarity:
P = Center Positive



N = Center Negative



*Contact CUI for additional plug options

REVISION HISTORY

rev.	description	date
1.0	initial release	01/24/2010
1.01	new template applied	12/22/2011
1.02	P7/P7R B dimension updated, V-Infinity branding removed, safety and EMI/EMC data updated	08/21/2012
1.03	updated series/model numbers	11/20/2012
1.04	corrected dc cord lengths	01/16/2013
1.05	added ac cord options	11/18/2014

The revision history provided is for informational purposes only and is believed to be accurate.



Headquarters
20050 SW 112th Ave.
Tualatin, OR 97062
800.275.4899

Fax 503.612.2383
cui.com
techsupport@cui.com

This device complies with part 15 of the FCC Rules. Operation is subject to the following two conditions:
(1) This device may not cause harmful interference, and
(2) this device must accept any interference received, including interference that may cause undesired operation.

CUI offers a one (1) year limited warranty. Complete warranty information is listed on our website.

CUI reserves the right to make changes to the product at any time without notice. Information provided by CUI is believed to be accurate and reliable. However, no responsibility is assumed by CUI for its use, nor for any infringements of patents or other rights of third parties which may result from its use.

CUI products are not authorized or warranted for use as critical components in equipment that requires an extremely high level of reliability. A critical component is any component of a life support device or system whose failure to perform can be reasonably expected to cause the failure of the life support device or system, or to affect its safety or effectiveness.