



SERIES: ETSA 150W U | **DESCRIPTION:** AC-DC POWER SUPPLY

FEATURES

- 150 W power
- universal input (90~264 Vac)
- single regulated outputs
- over voltage, over current, and short circuit protections
- UL/cUL safety approvals
- level VI efficiency
- power factor correction
- custom designs available



MODEL	output voltage	output current max	output power max	ripple and noise ¹ max	efficiency level
	(Vdc)	(A)	(W)	(mVp-p)	
ETSA1201167U	12	11.67	140	240	VI
ETSA160938U	16	9.38	150	320	VI
ETSA190790U	19	7.90	150	380	VI
ETSA240625U	24	6.25	150	480	VI
ETSA360417U	36	4.17	150	480	VI
ETSA480313U	48	3.13	150	480	VI

Notes: 1. Ripple and noise measured with 20 MHz bandwidth oscilloscope, each output terminated with 10 µF/50 V electrolytic and 0.1 µF ceramic capacitors.

PART NUMBER KEY

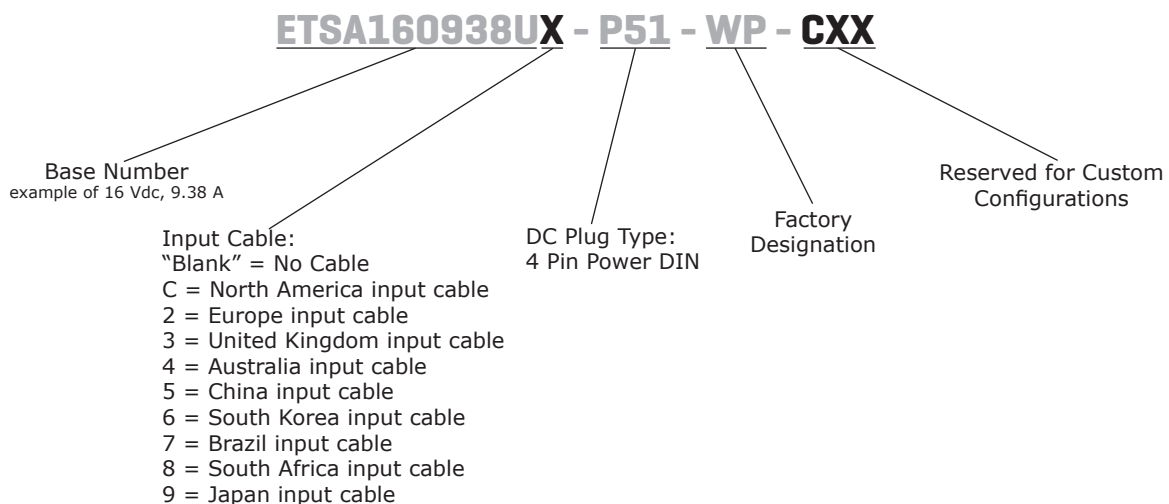

INPUT

parameter	conditions/description	min	typ	max	units
voltage		90		264	Vac
frequency		47		63	Hz
current	at 90 Vac, 50 Hz			2.5	A
inrush current	at 230 Vac, cold start			150	A
power factor correction	at full load		0.9		
no load power consumption				0.15	W

OUTPUT

parameter	conditions/description	min	typ	max	units
regulation	12, 16, 19 Vdc output models 24, 36, 48 Vdc output models		±5 ±3		% %
hold-up time	at 115/230 Vac, full load	16			ms
temperature coefficient				±0.05	%/°C

PROTECTIONS

parameter	conditions/description	min	typ	max	units
over voltage protection	output latch off	110		130	%
over current protection	output shut down, auto recovery	110		160	%
short circuit protection	output shut down, auto recovery				

SAFETY & COMPLIANCE

parameter	conditions/description	min	typ	max	units
isolation voltage	input to output for 4 seconds input to frame ground for 4 seconds		4,242 2,121		Vdc Vdc
isolation resistance	input to output at 500 Vdc input to frame ground at 500 Vdc	20 20			MΩ MΩ
safety approvals	UL/cUL, GS				
EMI/EMC	FCC Part 15 Class B, EN55022/EN55024 Class B, CE				
MTBF	at full load, 25°C	140,000			hours
RoHS	2011/65/EU				

ENVIRONMENTAL

parameter	conditions/description	min	typ	max	units
operating temperature	derate linearly 2.5% per °C from 41~60°C	0		60	°C
storage temperature		-10		85	°C
operating humidity	non-condensing	20		90	%
storage humidity	non-condensing	20		90	%

MECHANICAL

parameter	conditions/description	min	typ	max	units
dimensions	170 x 85 x 44				mm
inlet plug	IEC320 / C14				

MECHANICAL DRAWING

units: mm
tolerance: ±0.5 mm

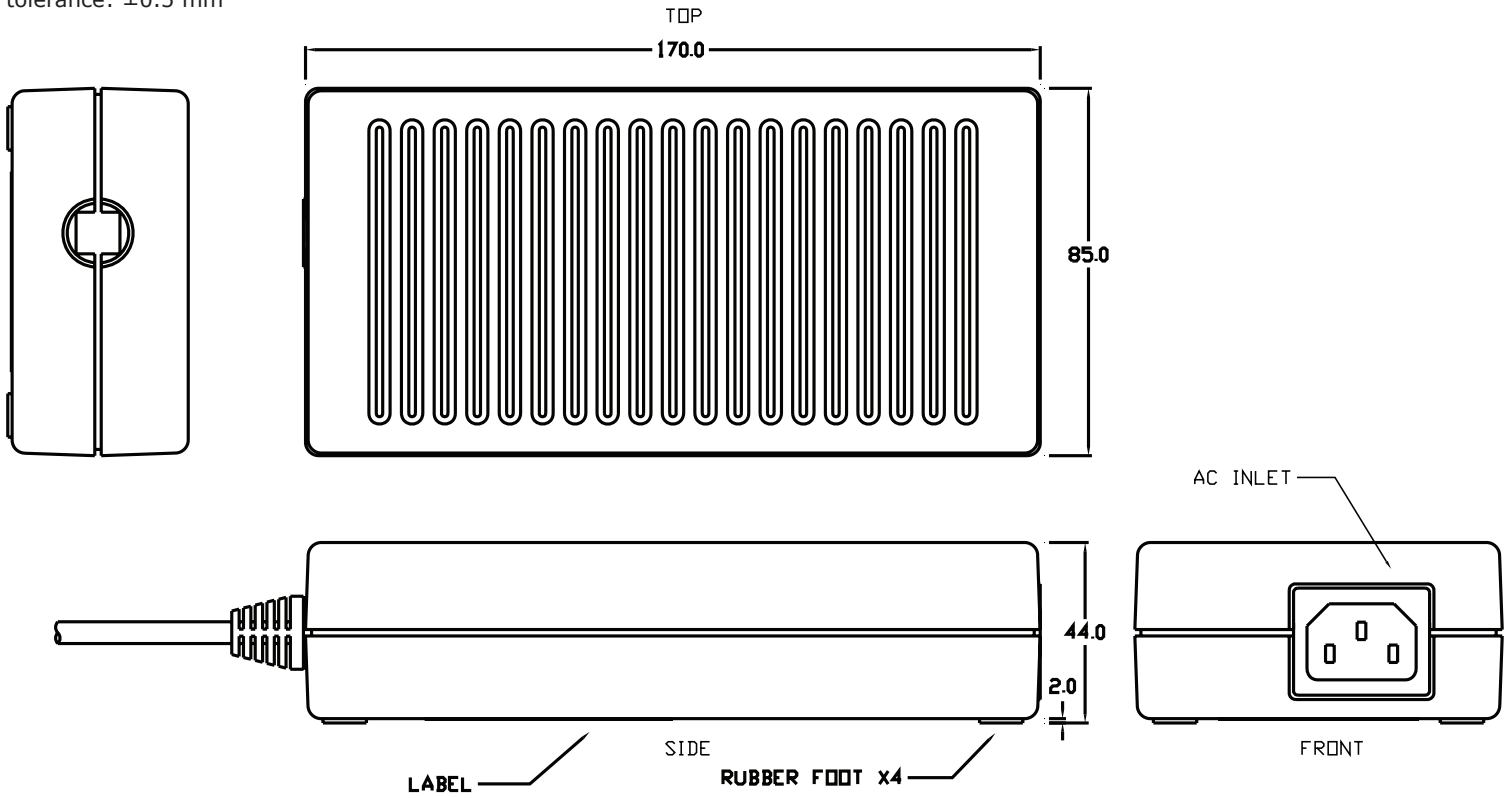

DC CORD

units: mm

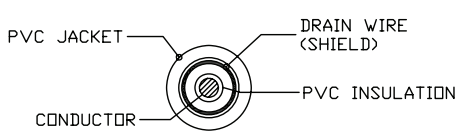

See Table 1
SECTIONAL DRAWING

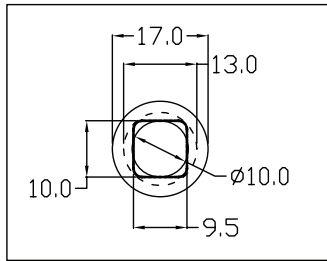
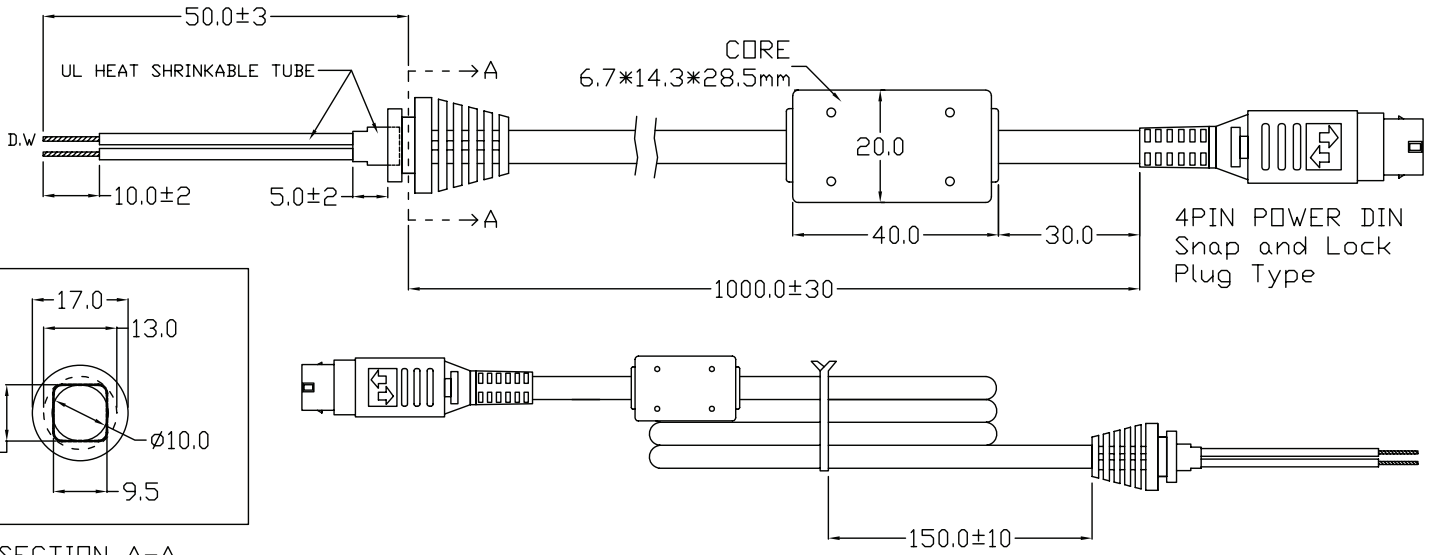
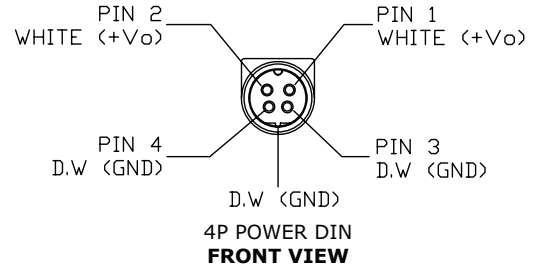

SECTION A-A

Table 1

MODEL NO.	CABLE
ETSA1201167U	14 AWG, Black, UL1571, 80°C, 30 V, 14 AWGX1C + aluminum shield (14 AWG)
ETSA160938U	14 AWG, Black, UL1571, 80°C, 30 V, 14 AWGX1C + aluminum shield (14 AWG)
ETSA190790U	14 AWG, Black, UL1571, 80°C, 30 V, 14 AWGX1C + aluminum shield (14 AWG)
ETSA240625U	14 AWG, Black, UL1571, 80°C, 30 V, 14 AWGX1C + aluminum shield (14 AWG)
ETSA360417U	16 AWG, Black, UL1185 80/90°C, 300 V, 16 AWGX1C + aluminum shield (16 AWG)
ETSA480313U	16 AWG, Black, UL1185 80/90°C, 300 V, 16 AWGX1C + aluminum shield (16 AWG)

AC CORD

units: mm

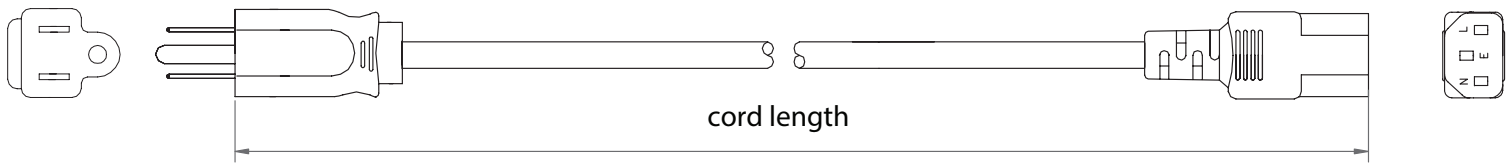

NORTH AMERICA

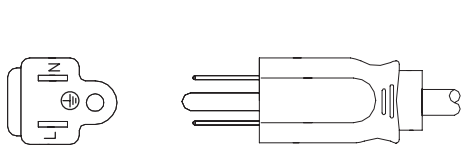

EUROPE

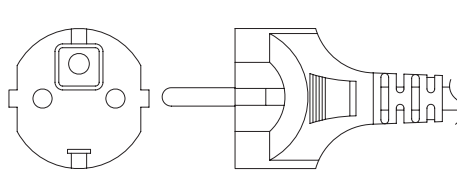

UNITED KINGDOM

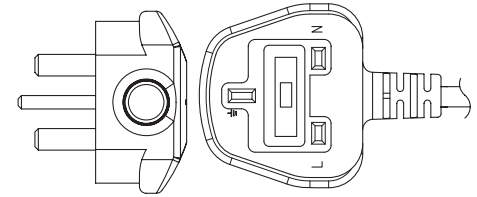

AUSTRALIA

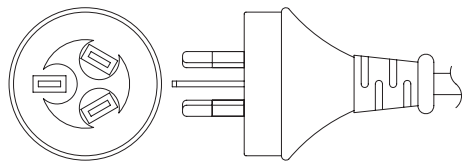

CHINA

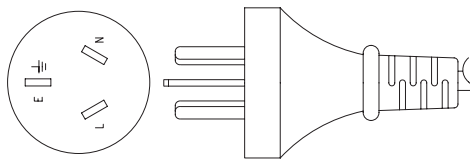

SOUTH KOREA

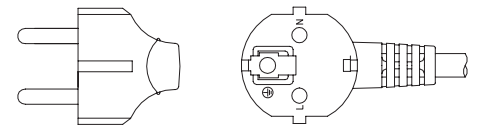

BRAZIL

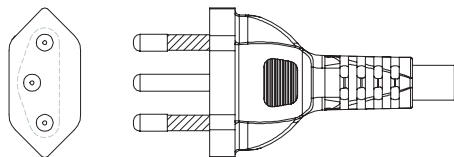

SOUTH AFRICA

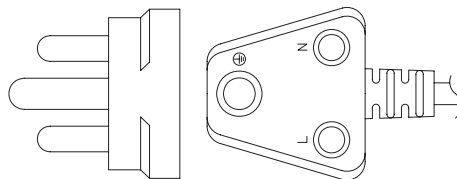

JAPAN

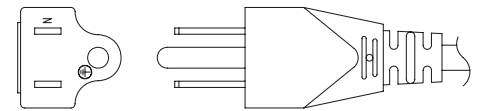

Table 2

AC INPUT	CORD LENGTH
North America	1,830 mm ±50
Europe	1,830 mm ±30
United Kingdom	1,800 mm ±50
Australia	1,830 mm ±30
China	1,830 mm ±50
South Korea	1,800 mm ±30
Brazil	1,830 mm ±30
South Africa	1,830 mm ±30
Japan	1,830 mm ±30

REVISION HISTORY

rev.	description	date
1.0	initial release	11/22/2013
1.01	added ac cord options	10/09/2014
1.02	updated to level VI efficiency	05/08/2015

The revision history provided is for informational purposes only and is believed to be accurate.



CUI INC[®]

Headquarters
20050 SW 112th Ave.
Tualatin, OR 97062
800.275.4899

Fax 503.612.2383
cui.com
techsupport@cui.com

This device complies with part 15 of the FCC Rules. Operation is subject to the following two conditions:

- (1) This device may not cause harmful interference, and
- (2) this device must accept any interference received, including interference that may cause undesired operation.

CUI offers a one (1) year limited warranty. Complete warranty information is listed on our website.

CUI reserves the right to make changes to the product at any time without notice. Information provided by CUI is believed to be accurate and reliable. However, no responsibility is assumed by CUI for its use, nor for any infringements of patents or other rights of third parties which may result from its use.

CUI products are not authorized or warranted for use as critical components in equipment that requires an extremely high level of reliability. A critical component is any component of a life support device or system whose failure to perform can be reasonably expected to cause the failure of the life support device or system, or to affect its safety or effectiveness.