

EL5462

500MHz Low Power Current Feedback Amplifier

FN7492
Rev 0.00
February 14, 2005

The EL5462 is a current feedback amplifier with a bandwidth of 500MHz which makes this amplifier ideal for today's high speed video and monitor applications.

With a supply current of just 1.5mA per amplifier and the ability to run from a single supply voltage from 5V to 12V, the EL5462 is also ideal for handheld, portable or battery-powered equipment.

The EL5462 is available in a 14-pin SO package and operates over the industrial temperature range of -40°C to +85°C.

Pinout

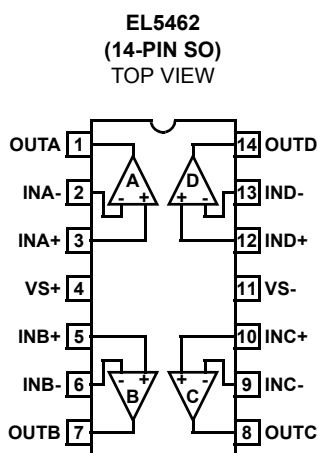

Features

- 500MHz -3dB bandwidth
- 4000V/μs slew rate
- 1.5mA supply current per amplifier
- Single and dual supply operation, from 5V to 12V supply span
- High speed, 1.4GHz product available (EL5167 & EL5167)
- High speed, 4mA, 630MHz product available (EL5164 & EL5165)
- Pb-free available (RoHS compliant)

Applications

- Battery-powered equipment
- Handheld, portable devices
- Video amplifiers
- Cable drivers
- RGB amplifiers
- Test equipment
- Instrumentation
- Current-to-voltage converters

Ordering Information

PART NUMBER	PACKAGE	TAPE & REEL	PKG. DWG. #
EL5462IS	14-Pin SO	-	MDP0027
EL5462IS-T7	14-Pin SO	7"	MDP0027
EL5462IS-T13	14-Pin SO	13"	MDP0027
EL5462ISZ (See Note)	14-Pin SO (Pb-Free)	-	MDP0027
EL5462ISZ-T7 (See Note)	14-Pin SO (Pb-Free)	7"	MDP0027
EL5462ISZ-T13 (See Note)	14-Pin SO (Pb-Free)	13"	MDP0027

NOTE: Intersil Pb-free products employ special Pb-free material sets; molding compounds/die attach materials and 100% matte tin plate termination finish, which are RoHS compliant and compatible with both SnPb and Pb-free soldering operations. Intersil Pb-free products are MSL classified at Pb-free peak reflow temperatures that meet or exceed the Pb-free requirements of IPC/JEDEC J STD-020.

Absolute Maximum Ratings ($T_A = 25^\circ\text{C}$)

Supply Voltage between V_{S+} and V_{S-}	13.2V	Pin Voltages.....	$V_{S-} - 0.5\text{V}$ to $V_{S+} + 0.5\text{V}$
Maximum Continuous Output Current.....	50mA	Power Dissipation.....	See Curves
Maximum Voltage between $IN+$ and $IN-$, Disabled.....	$\pm 1.5\text{V}$	Operating Junction Temperature.....	$+125^\circ\text{C}$
Current into $IN+$, $IN-$, CE	$\pm 5\text{mA}$	Storage Temperature.....	-65°C to $+150^\circ\text{C}$
Slew Rate from V_{S+} to V_{S-}	$1\text{V}/\mu\text{s}$	Ambient Operating Temperature.....	-40°C to $+85^\circ\text{C}$

CAUTION: Stresses above those listed in "Absolute Maximum Ratings" may cause permanent damage to the device. This is a stress only rating and operation of the device at these or any other conditions above those indicated in the operational sections of this specification is not implied.

IMPORTANT NOTE: All parameters having Min/Max specifications are guaranteed. Typical values are for information purposes only. Unless otherwise noted, all tests are at the specified temperature and are pulsed tests, therefore: $T_J = T_C = T_A$

Electrical Specifications $V_{S+} = +5\text{V}$, $V_{S-} = -5\text{V}$, $R_F = 750\Omega$ for $A_V = 1$, $R_F = 400\Omega$ for $A_V = 2$, $R_L = 150\Omega$, $T_A = 25^\circ\text{C}$ unless otherwise specified.

PARAMETER	DESCRIPTION	CONDITIONS	MIN	TYP	MAX	UNIT
AC PERFORMANCE						
BW	-3dB Bandwidth	$A_V = +1$, $R_L = 500\Omega$, $R_F = 598\Omega$		500		MHz
		$A_V = +2$, $R_L = 150\Omega$, $R_F = 422\Omega$		233		MHz
BW1	0.1dB Bandwidth			30		MHz
SR	Slew Rate	$V_O = -2.5\text{V}$ to $+2.5\text{V}$, $A_V = +2$, $R_L = 100\Omega$	2500	4000	5000	$\text{V}/\mu\text{s}$
t_S	0.1% Settling Time	$V_{OUT} = -2.5\text{V}$ to $+2.5\text{V}$, $A_V = +1$		25		ns
e_N	Input Voltage Noise			3		$\text{nV}/\sqrt{\text{Hz}}$
i_{N-}	$IN-$ Input Current Noise			10		$\text{pA}/\sqrt{\text{Hz}}$
i_{N+}	$IN+$ Input Current Noise			6.5		$\text{pA}/\sqrt{\text{Hz}}$
dG	Differential Gain Error (Note 1)	$A_V = +2$		0.05		%
dP	Differential Phase Error (Note 1)	$A_V = +2$		0.15		$^\circ$
DC PERFORMANCE						
V_{OS}	Offset Voltage		-5	1.5	+5	mV
$T_C V_{OS}$	Input Offset Voltage Temperature Coefficient	Measured from T_{MIN} to T_{MAX}		6		$\mu\text{V}/^\circ\text{C}$
R_{OL}	Transimpedance		500	1000		$\text{k}\Omega$
INPUT CHARACTERISTICS						
CMIR	Common Mode Input Range	Guaranteed by CMRR test	± 3	± 3.3		V
CMRR	Common Mode Rejection Ratio	$V_{IN} = \pm 3\text{V}$	50	62	75	dB
-ICMR	- Input Current Common Mode Rejection		-1	0.22	+1	$\mu\text{A}/\text{V}$
$+I_{IN}$	+ Input Current		-8	0.5	+8	μA
$-I_{IN}$	- Input Current		-10	2	+10	μA
R_{IN}	Input Resistance		0.8	1.6	3	$\text{M}\Omega$
C_{IN}	Input Capacitance			1		pF
OUTPUT CHARACTERISTICS						
V_O	Output Voltage Swing	$R_L = 150\Omega$ to GND	± 3.35	± 3.6	± 3.75	V
		$R_L = 1\text{k}\Omega$ to GND	± 3.75	± 3.9	± 4.15	V
I_{OUT}	Output Current	$R_L = 10\Omega$ to GND	60	100		mA

Electrical Specifications $V_{S+} = +5V$, $V_{S-} = -5V$, $R_F = 750\Omega$ for $A_V = 1$, $R_F = 400\Omega$ for $A_V = 2$, $R_L = 150\Omega$, $T_A = 25^\circ C$ unless otherwise specified. (Continued)

PARAMETER	DESCRIPTION	CONDITIONS	MIN	TYP	MAX	UNIT
SUPPLY						
I_{SON}	Supply Current - Enabled, per Amplifier	No load, $V_{IN} = 0V$	1.3	1.5	1.7	mA
PSRR	Power Supply Rejection Ratio	DC, $V_S = \pm 4.75V$ to $\pm 5.25V$	65	76		dB
-IPSR	- Input Current Power Supply Rejection	DC, $V_S = \pm 4.75V$ to $\pm 5.25V$	-0.5	0.1	+0.5	$\mu A/V$

NOTE:

- Standard NTSC test, AC signal amplitude = 286mV_{p-p}, f = 3.58MHz

Typical Performance Curves

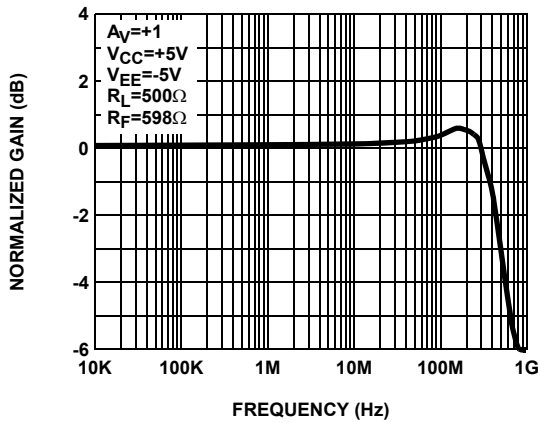

FIGURE 1. FREQUENCY RESPONSE FOR $A_V = +1$

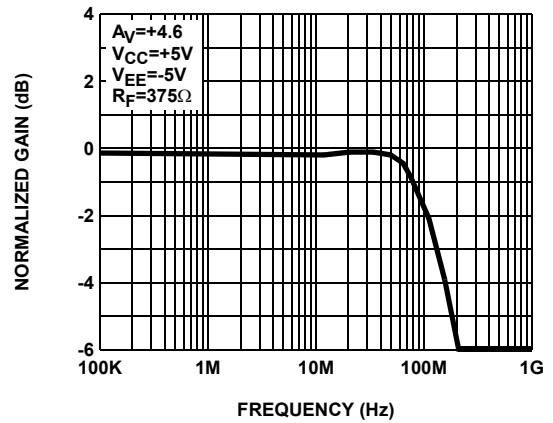

FIGURE 2. FREQUENCY RESPONSE FOR $A_V = +4.6$

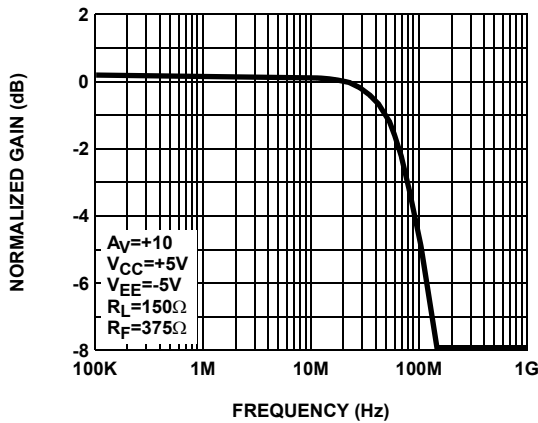

FIGURE 3. FREQUENCY RESPONSE FOR $A_V = +10$

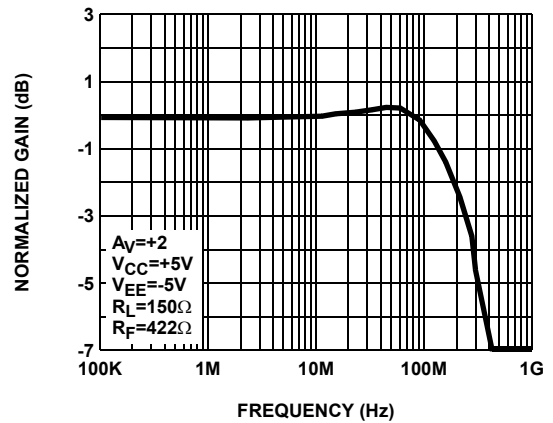

FIGURE 4. FREQUENCY RESPONSE FOR $A_V = +2$

Typical Performance Curves (Continued)

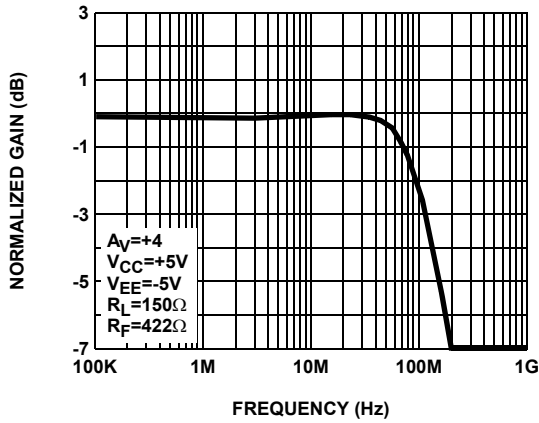

FIGURE 5. FREQUENCY RESPONSE FOR $A_V=+4$

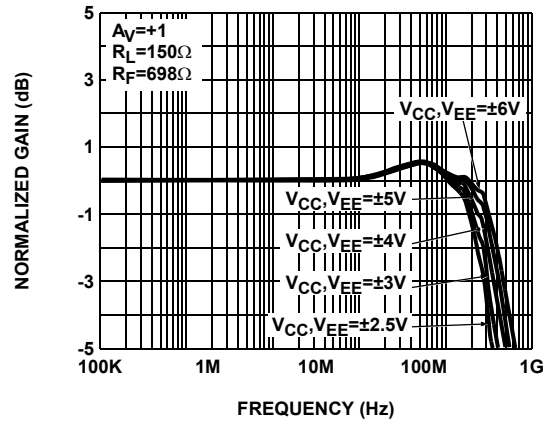

FIGURE 6. FREQUENCY RESPONSE FOR VARIOUS V_{CC}, V_{EE}

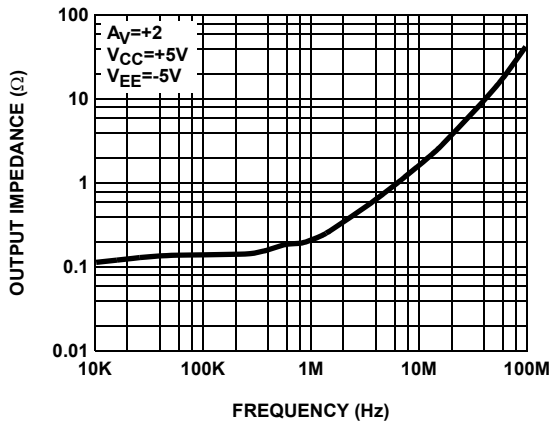

FIGURE 7. CLOSED LOOP OUTPUT IMPEDANCE

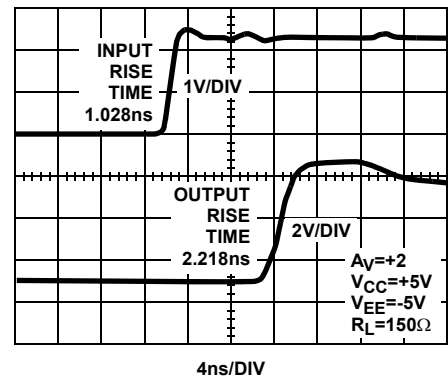

FIGURE 8. OUTPUT RISE TIME

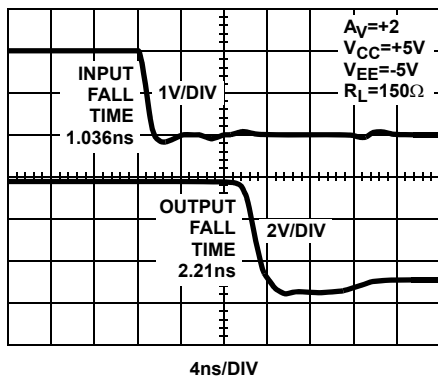

FIGURE 9. OUTPUT FALL TIME

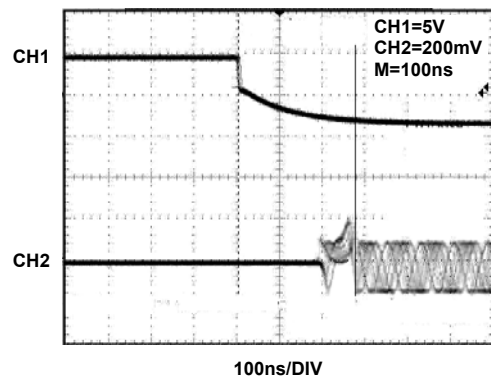

FIGURE 10. TURN ON TIME

Typical Performance Curves (Continued)

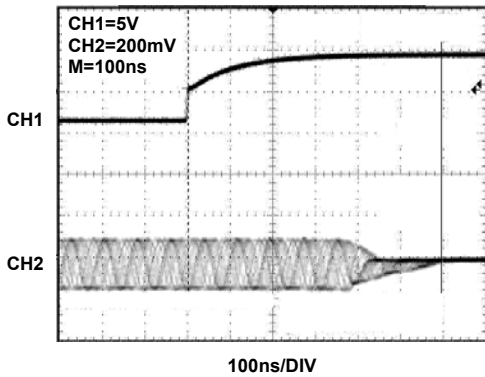

FIGURE 11. TURN OFF TIME

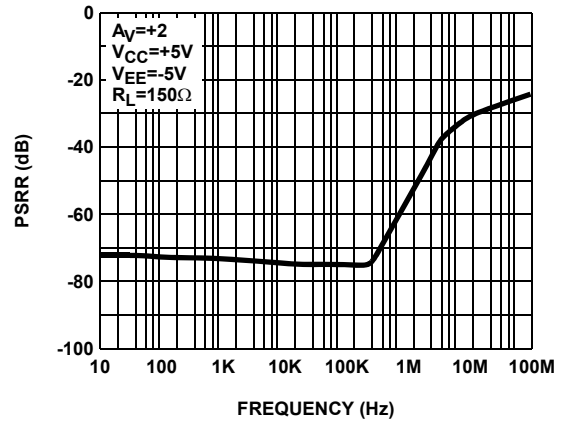

FIGURE 12. PSRR (V_{CC})

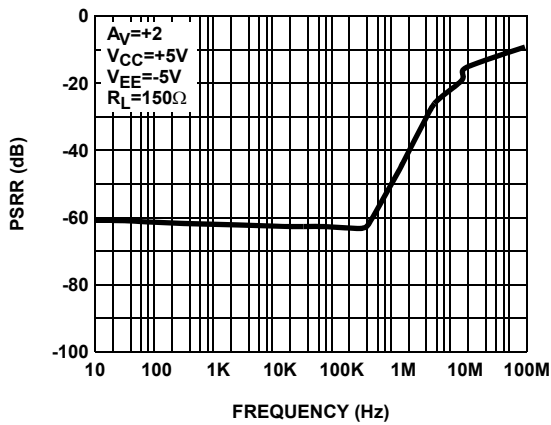

FIGURE 13. PSRR (V_{EE})

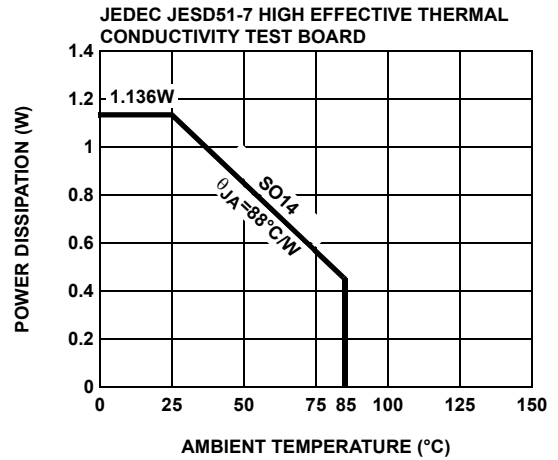

FIGURE 14. PACKAGE POWER DISSIPATION vs AMBIENT TEMPERATURE

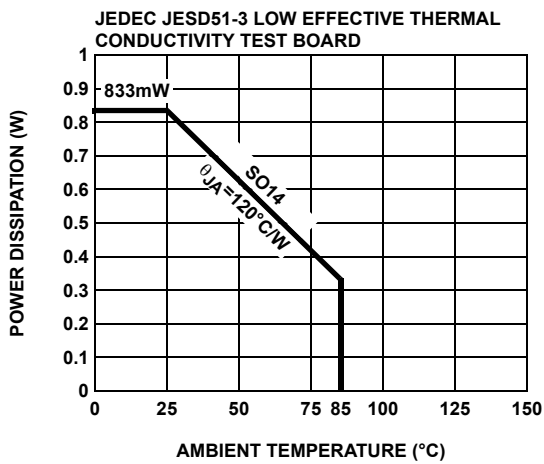
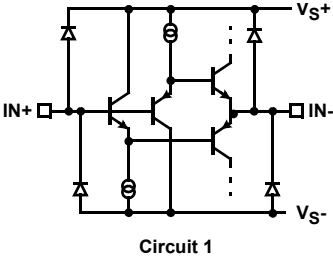
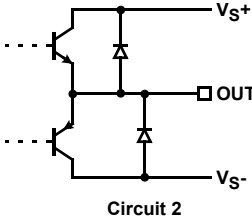

FIGURE 15. PACKAGE POWER DISSIPATION vs AMBIENT TEMPERATURE

Pin Descriptions

EL5462	PIN NAME	FUNCTION	EQUIVALENT CIRCUIT
2, 6, 9, 13	IN-	Inverting input	 <p style="text-align: center;">Circuit 1</p>
3, 5, 10, 12	IN+	Non-inverting input	(See circuit 1)
11	VS-	Negative supply	
1, 7, 8, 14	OUT	Output	 <p style="text-align: center;">Circuit 2</p>
4	VS+	Positive supply	

Applications Information

Product Description

The EL5462 is a low power, current-feedback operational amplifier that offers a wide -3dB bandwidth of 500MHz and a low supply current of 1.5mA per amplifier. The EL5462 works with supply voltages ranging from a single 5V to 10V and they are also capable of swinging to within 1V of either supply on the output. Because of its current-feedback topology, the EL5462 does not have the normal gain-bandwidth product associated with voltage-feedback operational amplifiers. Instead, its -3dB bandwidth to remain relatively constant as closed-loop gain is increased. This combination of high bandwidth and low power, together with aggressive pricing makes the EL5462 the ideal choice for many low-power/high-bandwidth applications such as portable, handheld, or battery-powered equipment.

Power Supply Bypassing and Printed Circuit Board Layout

As with any high frequency device, a good printed circuit board layout is necessary for optimum performance. Low impedance ground plane construction is essential. Surface mount components are recommended, but if leaded components are used, lead lengths should be as short as possible. The power supply pins must be well bypassed to reduce the risk of oscillation. The combination of a 4.7 μ F tantalum capacitor in parallel with a 0.01 μ F capacitor has been shown to work well when placed at each supply pin.

For good AC performance, parasitic capacitance should be kept to a minimum, especially at the inverting input. (See the Capacitance at the Inverting Input section) Even when

ground plane construction is used, it should be removed from the area near the inverting input to minimize any stray capacitance at that node. Carbon or Metal-Film resistors are acceptable with the Metal-Film resistors giving slightly less peaking and bandwidth because of additional series inductance. Use of sockets, particularly for the SO package, should be avoided if possible. Sockets add parasitic inductance and capacitance which will result in additional peaking and overshoot.

Capacitance at the Inverting Input

Any manufacturer's high-speed voltage or current-feedback amplifier can be affected by stray capacitance at the inverting input. For inverting gains, this parasitic capacitance has little effect because the inverting input is a virtual ground, but for non-inverting gains, this capacitance (in conjunction with the feedback and gain resistors) creates a pole in the feedback path of the amplifier. This pole, if low enough in frequency, has the same destabilizing effect as a zero in the forward open-loop response. The use of large-value feedback and gain resistors exacerbates the problem by further lowering the pole frequency (increasing the possibility of oscillation.)

The EL5462 has been optimized with a 600 Ω feedback resistor. With the high bandwidth of these amplifiers, these resistor values might cause stability problems when combined with parasitic capacitance, thus ground plane is not recommended around the inverting input pin of the amplifier.

Feedback Resistor Values

The EL5462 has been designed and specified at a gain of +1 with R_F approximately 606Ω . This value of feedback resistor gives 500MHz of -3dB bandwidth at $A_V = 1$ with 0.5dB of peaking. With $A_V = -2$, an R_F of approximately 600Ω gives 300MHz of bandwidth with 1dB of peaking. Since the EL5462 is a current-feedback amplifier, it is also possible to change the value of R_F to get more bandwidth. As seen in the curve of Frequency Response for Various R_F and R_G , bandwidth and peaking can be easily modified by varying the value of the feedback resistor.

Because the EL5462 is a current-feedback amplifier, its gain-bandwidth product is not a constant for different closed-loop gains. This feature actually allows the EL5462 to maintain about the same -3dB bandwidth. As gain is increased, bandwidth decreases slightly while stability increases. Since the loop stability is improving with higher closed-loop gains, it becomes possible to reduce the value of R_F below the specified $TBD\Omega$ and still retain stability, resulting in only a slight loss of bandwidth with increased closed-loop gain.

Supply Voltage Range and Single-Supply Operation

The EL5462 has been designed to operate with supply voltages having a span of greater than 5V and less than 10V. In practical terms, this means that they will operate on dual supplies ranging from $\pm 2.5V$ to $\pm 5V$. With single-supply, the EL5462 will operate from 5V to 10V.

As supply voltages continue to decrease, it becomes necessary to provide input and output voltage ranges that can get as close as possible to the supply voltages. The EL5462 has an input range which extends to within 2V of either supply. So, for example, on +5V supplies, the EL5462 has an input range which spans $\pm 3V$. The output range of the EL5462 is also quite large, extending to within 1V of the supply rail. On a $\pm 5V$ supply, the output is therefore capable of swinging from -4V to +4V. Single-supply output range is larger because of the increased negative swing due to the external pull-down resistor to ground.

Video Performance

For good video performance, an amplifier is required to maintain the same output impedance and the same frequency response as DC levels are changed at the output. This is especially difficult when driving a standard video load of 150Ω , because of the change in output current with DC level. Previously, good differential gain could only be achieved by running high idle currents through the output transistors (to reduce variations in output impedance.) These currents were typically comparable to the entire 1mA supply current of the EL5462 amplifier. Special circuitry has been incorporated in the EL5462 to reduce the variation of output impedance with current output. This results in dG and dP specifications of 0.1% and 0.1° , while driving 150Ω at a gain of 2.

Video performance has also been measured with a 500Ω load at a gain of +1. Under these conditions, the EL5462 has dG and dP specifications of 0.1% and 0.1° .

Output Drive Capability

In spite of its low 1.5mA of supply current, the EL5462 is capable of providing a minimum of $\pm 50mA$ of output current. With a minimum of $\pm 50mA$ of output drive, the EL5462 is capable of driving 50Ω loads to both rails, making it an excellent choice for driving isolation transformers in telecommunications applications.

Driving Cables and Capacitive Loads

When used as a cable driver, double termination is always recommended for reflection-free performance. For those applications, the back-termination series resistor will decouple the EL5462 from the cable and allow extensive capacitive drive. However, other applications may have high capacitive loads without a back-termination resistor. In these applications, a small series resistor (usually between 5Ω and 50Ω) can be placed in series with the output to eliminate most peaking. The gain resistor (R_G) can then be chosen to make up for any gain loss which may be created by this additional resistor at the output. In many cases it is also possible to simply increase the value of the feedback resistor (R_F) to reduce the peaking.

Current Limiting

The EL5462 has no internal current-limiting circuitry. If the output is shorted, it is possible to exceed the Absolute Maximum Rating for output current or power dissipation, potentially resulting in the destruction of the device.

Power Dissipation

With the high output drive capability of the EL5462, it is possible to exceed the $125^\circ C$ Absolute Maximum junction temperature under certain very high load current conditions. Generally speaking when R_L falls below about 25Ω , it is important to calculate the maximum junction temperature (T_{JMAX}) for the application to determine if power supply voltages, load conditions, or package type need to be modified for the EL5462 to remain in the safe operating area. These parameters are calculated as follows:

$$T_{JMAX} = T_{MAX} + (\theta_{JA} \times n \times PD_{MAX})$$

where:

- T_{MAX} = Maximum ambient temperature
- θ_{JA} = Thermal resistance of the package
- n = Number of amplifiers in the package
- PD_{MAX} = Maximum power dissipation of each amplifier in the package

PD_{MAX} for each amplifier can be calculated as follows:

$$PD_{MAX} = (2 \times V_S \times I_{SMAX}) + \left[(V_S - V_{OUTMAX}) \times \frac{V_{OUTMAX}}{R_L} \right]$$

where:

- V_S = Supply voltage
- $I_{S\text{MAX}}$ = Maximum supply current of 1.5mA
- V_{OUTMAX} = Maximum output voltage (required)
- R_L = Load resistance

Typical Application Circuits

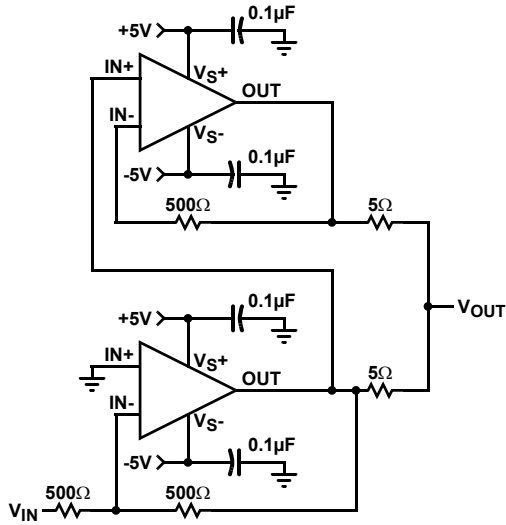

FIGURE 16. INVERTING 200mA OUTPUT CURRENT DISTRIBUTION AMPLIFIER

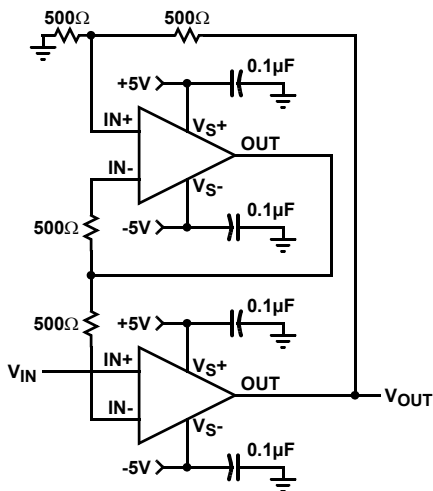
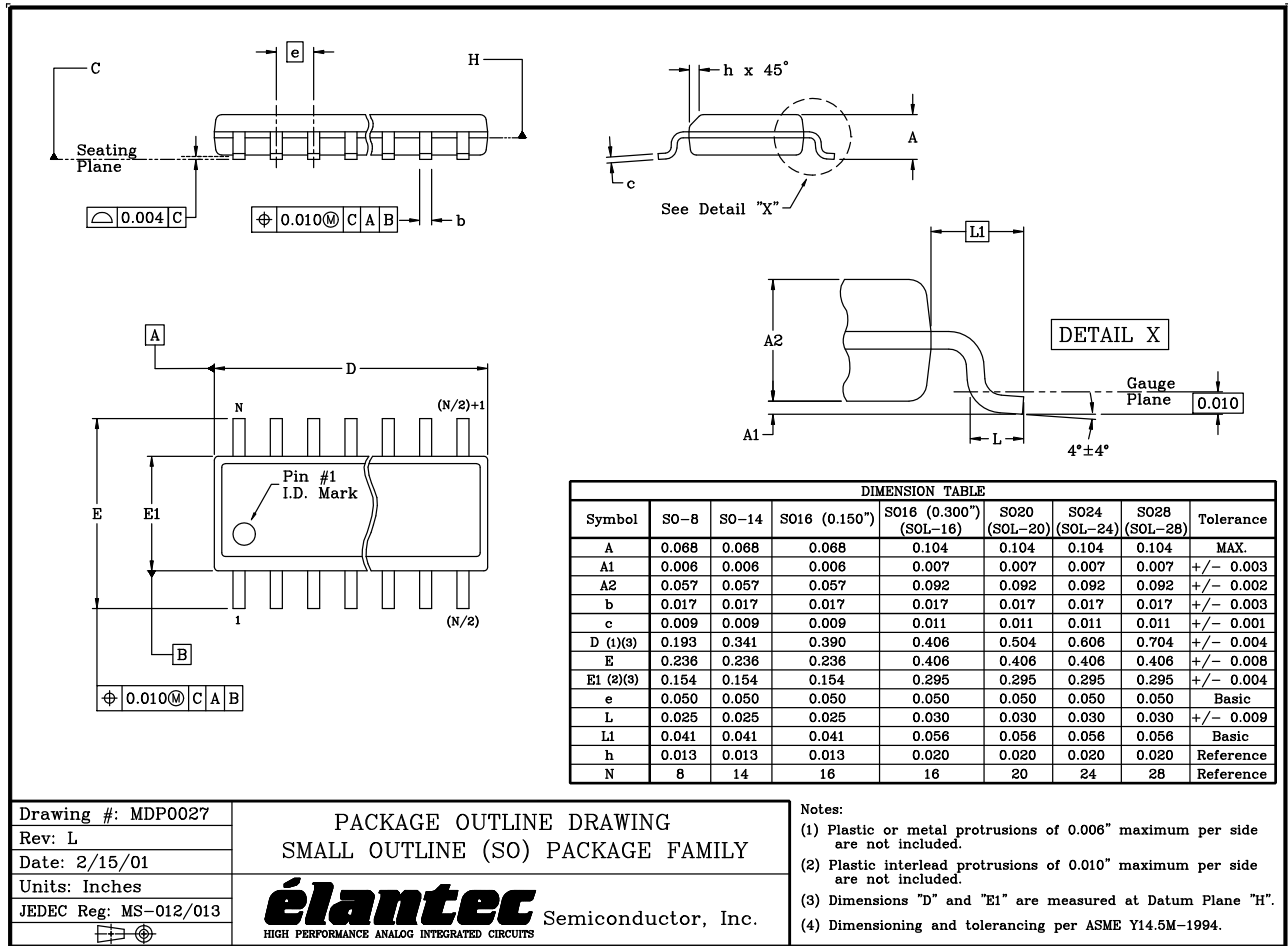

FIGURE 17. FAST-SETTLING PRECISION AMPLIFIER

SO Package Outline Drawing



Drawing #: MDP0027
 Rev: L
 Date: 2/15/01
 Units: Inches
 JEDEC Reg: MS-012/013

PACKAGE OUTLINE DRAWING
 SMALL OUTLINE (SO) PACKAGE FAMILY
elantec Semiconductor, Inc.
 HIGH PERFORMANCE ANALOG INTEGRATED CIRCUITS

Notes:
 (1) Plastic or metal protrusions of 0.006" maximum per side are not included.
 (2) Plastic interlead protrusions of 0.010" maximum per side are not included.
 (3) Dimensions "D" and "E1" are measured at Datum Plane "H".
 (4) Dimensioning and tolerancing per ASME Y14.5M-1994.

NOTE: The package drawing shown here may not be the latest version. To check the latest revision, please refer to the Intersil website at <http://www.intersil.com/design/packages/index.asp>

© Copyright Intersil Americas LLC 2005. All Rights Reserved.
 All trademarks and registered trademarks are the property of their respective owners.

For additional products, see www.intersil.com/en/products.html

Intersil products are manufactured, assembled and tested utilizing ISO9001 quality systems as noted in the quality certifications found at www.intersil.com/en/support/qualandreliability.html

Intersil products are sold by description only. Intersil may modify the circuit design and/or specifications of products at any time without notice, provided that such modification does not, in Intersil's sole judgment, affect the form, fit or function of the product. Accordingly, the reader is cautioned to verify that datasheets are current before placing orders. Information furnished by Intersil is believed to be accurate and reliable. However, no responsibility is assumed by Intersil or its subsidiaries for its use; nor for any infringements of patents or other rights of third parties which may result from its use. No license is granted by implication or otherwise under any patent or patent rights of Intersil or its subsidiaries.

For information regarding Intersil Corporation and its products, see www.intersil.com