

EL5292, EL5292A

Dual 600MHz Current Feedback Amplifier with Enable

FN7192
Rev 1.00
June 28, 2007

The EL5292 and EL5292A represent dual current feedback amplifiers with a very high bandwidth of 600MHz. This makes these amplifiers ideal for today's high speed video and monitor applications.

With a supply current of just 6mA per amplifier and the ability to run from a single supply voltage from 5V to 10V, these amplifiers are also ideal for hand held, portable or battery powered equipment.

The EL5292A also incorporates an enable and disable function to reduce the supply current to 100µA typical per amplifier. Allowing the \overline{CE} pin to float or applying a low logic level will enable the amplifier.

The EL5292 is offered in the industry-standard 8 Ld SOIC package and the space-saving 8 Ld MSOP package. The EL5292A is available in a 10 Ld MSOP package and all operate over the industrial temperature range of -40°C to +85°C.

Pinouts

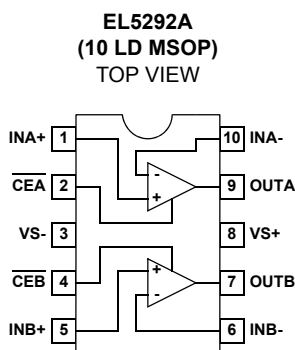
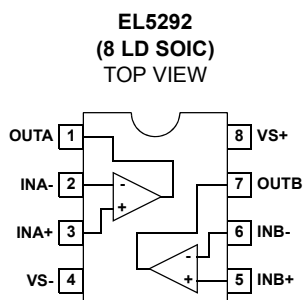

Features

- 600MHz -3dB bandwidth
- 6mA supply current (per amplifier)
- Single and dual supply operation, from 5V to 10V
- Fast enable/disable (EL5292A only)
- Single (EL5192) and triple (EL5392) available
- High speed, 1GHz product available (EL5191)
- Low power, 4mA, 300MHz product available (EL5193, EL5293, and EL5393)

Applications

- Video amplifiers
- Cable drivers
- RGB amplifiers
- Test equipment
- Instrumentation
- Current to voltage converters

Ordering Information

PART NUMBER	PART MARKING	PACKAGE	PKG. DWG. #
EL5292CS	5292CS	8 Ld SOIC	MDP0027
EL5292CS-T7*	5292CS	8 Ld SOIC	MDP0027
EL5292CS-T13*	5292CS	8 Ld SOIC	MDP0027
EL5292ACY	T	10 Ld MSOP	MDP0043
EL5292ACY-T7*	T	10 Ld MSOP	MDP0043
EL5292ACY-T13*	T	10 Ld MSOP	MDP0043

*"-T7" or "-T13" suffix is for tape and reel. Please refer to TB347 for details on reel specifications.

Absolute Maximum Ratings ($T_A = +25^\circ\text{C}$)

Supply Voltage between V_{S+} and V_{S-}	11V
Pin Voltages.....	$V_{S-} -0.5\text{V}$ to $V_{S+} +0.5\text{V}$
Maximum Continuous Output Current.....	50mA

Thermal Information

Storage Temperature.....	-65°C to $+150^\circ\text{C}$
Operating Temperature.....	-40°C to $+85^\circ\text{C}$
Operating Junction Temperature.....	$+125^\circ\text{C}$
Power Dissipation.....	See Curves
Pb-free reflow profile.....	see link below http://www.intersil.com/pbfree/Pb-FreeReflow.asp

CAUTION: Do not operate at or near the maximum ratings listed for extended periods of time. Exposure to such conditions may adversely impact product reliability and result in failures not covered by warranty.

Electrical Specifications $V_{S+} = +5\text{V}$, $V_{S-} = -5\text{V}$, $R_F = 750\Omega$ for $A_V = 1$, $R_F = 375\Omega$ for $A_V = 2$, $R_L = 150\Omega$, $T_A = +25^\circ\text{C}$ unless otherwise specified.

PARAMETER	DESCRIPTION	CONDITIONS	MIN (Note 2)	TYP	MAX (Note 2)	UNIT
AC PERFORMANCE						
BW	-3dB Bandwidth	$A_V = +1$		600		MHz
		$A_V = +2$		300		MHz
BW1	0.1dB Bandwidth			25		MHz
SR	Slew Rate	$V_O = -2.5\text{V}$ to $+2.5\text{V}$, $A_V = +2$	2000	2300		V/ μs
t_S	0.1% Settling Time	$V_{OUT} = -2.5\text{V}$ to $+2.5\text{V}$, $A_V = -1$		9		ns
C_S	Channel Separation	$f = 5\text{MHz}$		60		dB
e_N	Input Voltage Noise			4.1		nV/ $\sqrt{\text{Hz}}$
i_{N-}	IN- Input Current Noise			20		pA/ $\sqrt{\text{Hz}}$
i_{N+}	IN+ Input Current Noise			50		pA/ $\sqrt{\text{Hz}}$
dG	Differential Gain Error (Note 1)	$A_V = +2$		0.015		%
dP	Differential Phase Error (Note 1)	$A_V = +2$		0.04		°
DC PERFORMANCE						
V_{OS}	Offset Voltage		-10	1	10	mV
$T_C V_{OS}$	Input Offset Voltage Temperature Coefficient	Measured from T_{MIN} to T_{MAX}		5		$\mu\text{V}/^\circ\text{C}$
R_{OL}	Transimpedance		200	400		k Ω
INPUT CHARACTERISTICS						
CMIR	Common Mode Input Range		± 3	± 3.3		V
CMRR	Common Mode Rejection Ratio		42	50		dB
$+I_{IN}$	+ Input Current		-60	3	60	μA
$-I_{IN}$	- Input Current		-35	4	35	μA
R_{IN}	Input Resistance			37		k Ω
C_{IN}	Input Capacitance			0.5		pF
OUTPUT CHARACTERISTICS						
V_O	Output Voltage Swing	$R_L = 150\Omega$ to GND	± 3.4	± 3.7		V
		$R_L = 1\text{k}\Omega$ to GND	± 3.8	± 4.0		V
I_{OUT}	Output Current	$R_L = 10\Omega$ to GND	95	120		mA
SUPPLY						
I_{SON}	Supply Current - Enabled	No load, $V_{IN} = 0\text{V}$	5	6	7.5	mA
I_{SOFF}	Supply Current - Disabled	No load, $V_{IN} = 0\text{V}$		100	150	μA
PSRR	Power Supply Rejection Ratio	DC, $V_S = \pm 4.75\text{V}$ to $\pm 5.25\text{V}$	55	75		dB

Electrical Specifications $V_{S+} = +5V$, $V_{S-} = -5V$, $R_F = 750\Omega$ for $A_V = 1$, $R_F = 375\Omega$ for $A_V = 2$, $R_L = 150\Omega$, $T_A = +25^\circ C$ unless otherwise specified. **(Continued)**

PARAMETER	DESCRIPTION	CONDITIONS	MIN (Note 2)	TYP	MAX (Note 2)	UNIT
-IPSR	- Input Current Power Supply Rejection	DC, $V_S = \pm 4.75$ to $\pm 5.25V$	-2		2	$\mu A/V$
ENABLE (EL5292A Only)						
t_{EN}	Enable Time			40		ns
t_{DIS}	Disable Time			600		ns
I_{IHCE}	CE Pin Input High Current	$\overline{CE} = V_{S+}$		0.8	6	μA
I_{ILCE}	CE Pin Input Low Current	$\overline{CE} = V_{S-}$		0	-0.1	μA
V_{IHCE}	CE Input High Voltage for Power-down		$V_{S+} - 1$			V
V_{ILCE}	CE Input Low Voltage for Power-down				$V_{S+} - 3$	V

NOTE:

- Standard NTSC test, AC signal amplitude = 286mV_{p-p}, f = 3.58MHz
- Parts are 100% tested at +25°C. Over temperature limits established by characterization and are not production tested.

Typical Performance Curves

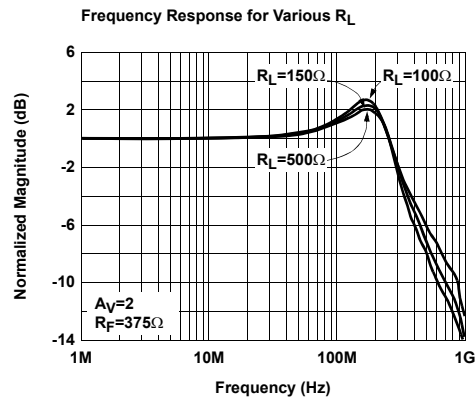
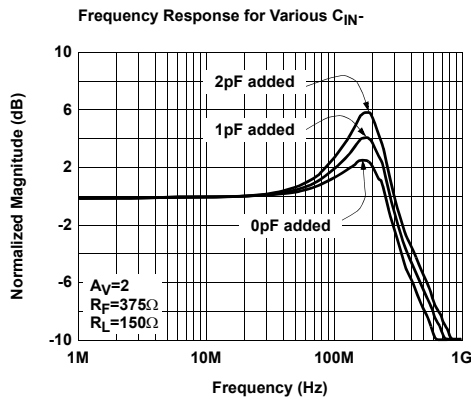
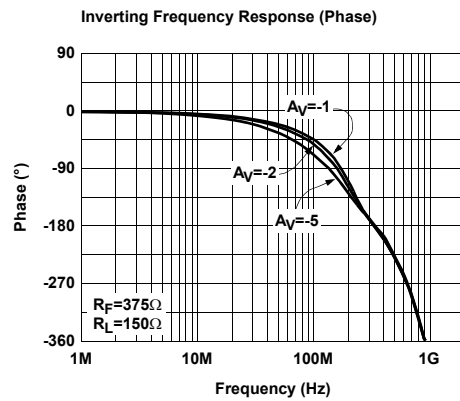
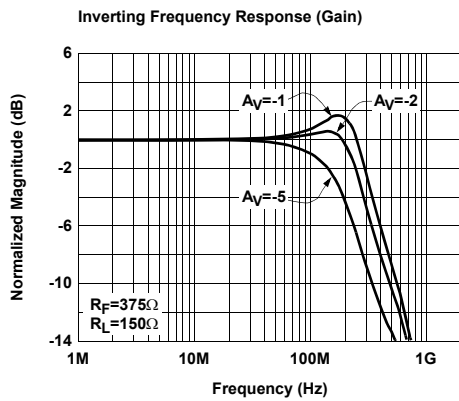
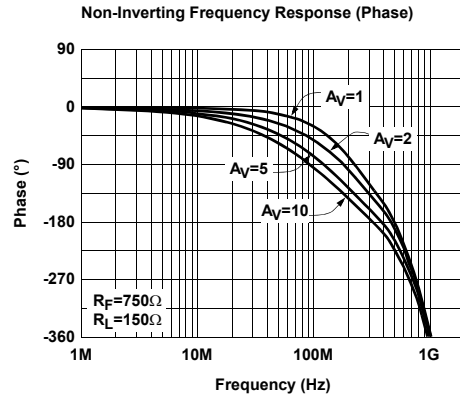
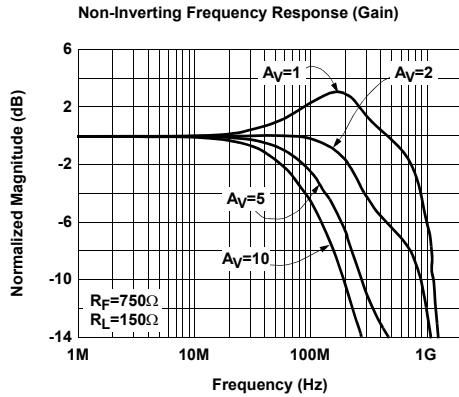

Typical Performance Curves (Continued)

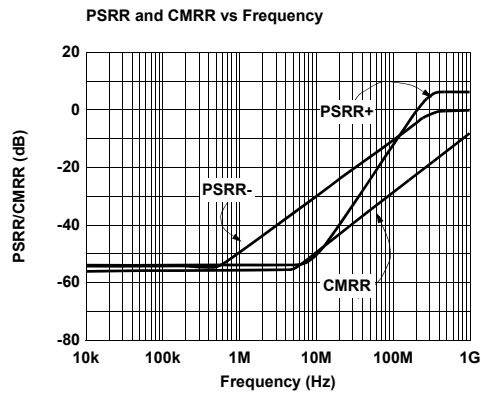
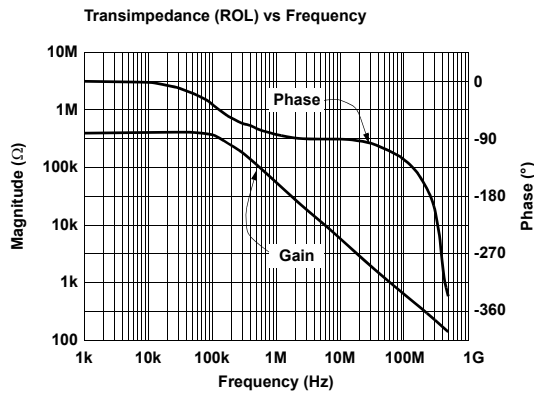
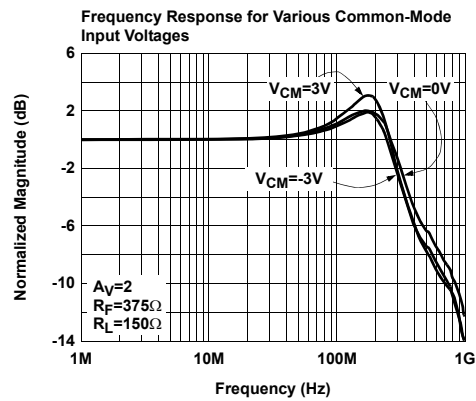
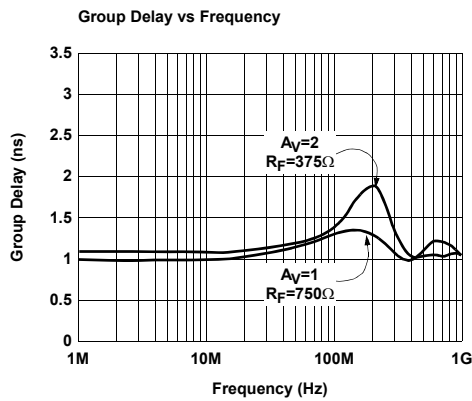
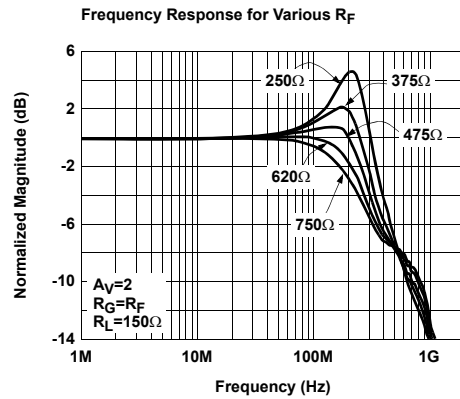
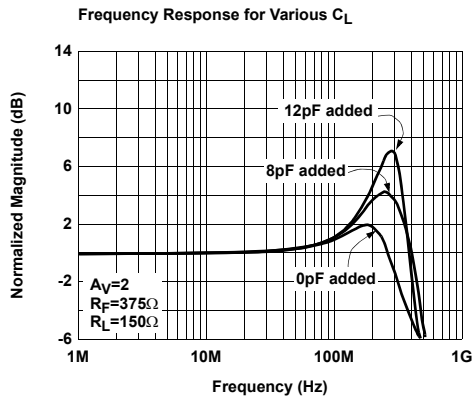

Typical Performance Curves (Continued)

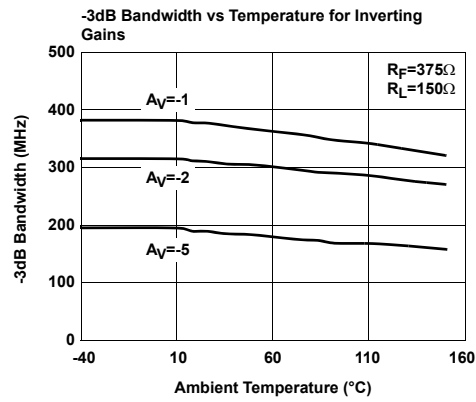
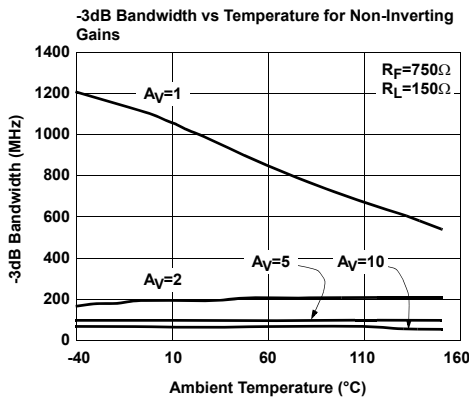
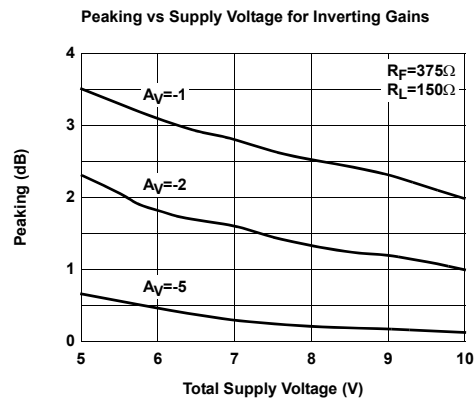
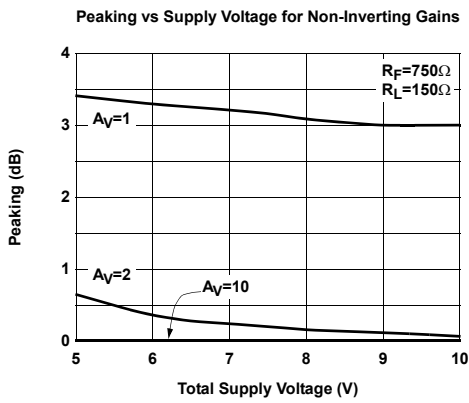
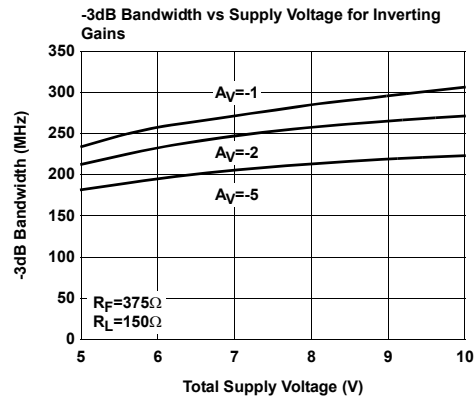
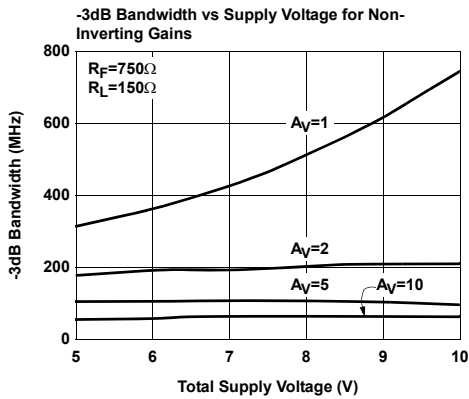

Typical Performance Curves (Continued)

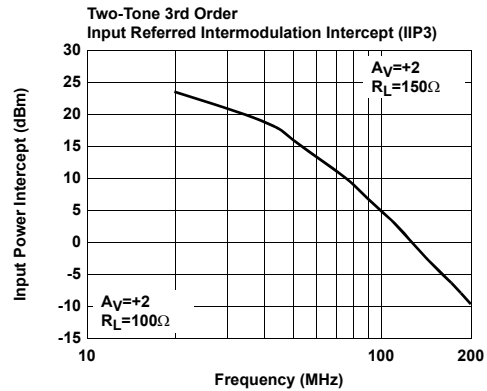
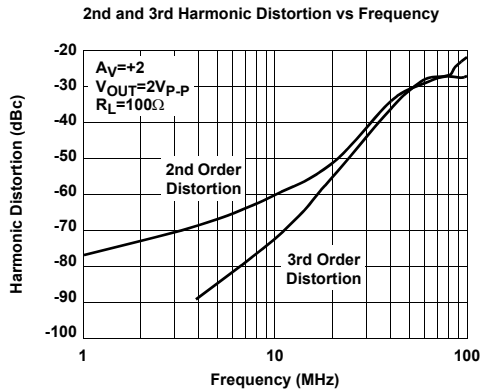
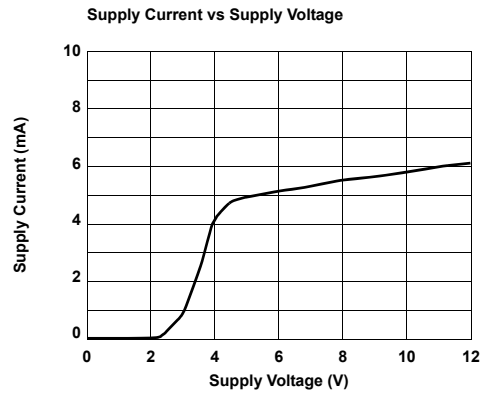
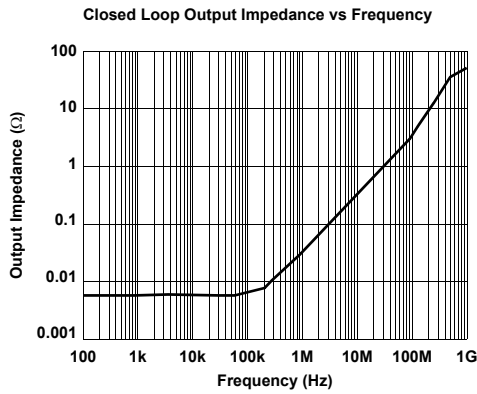
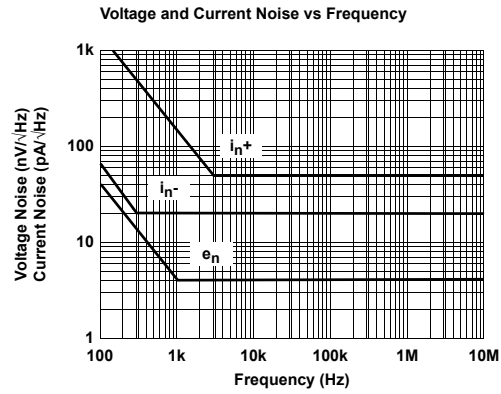
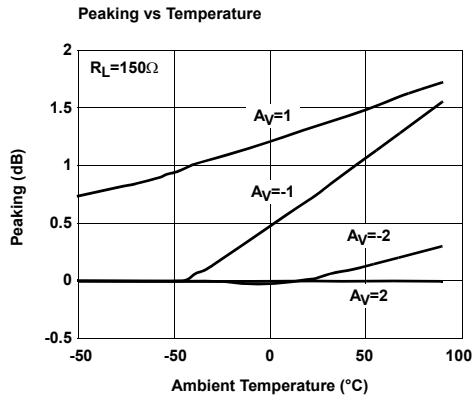

Typical Performance Curves (Continued)

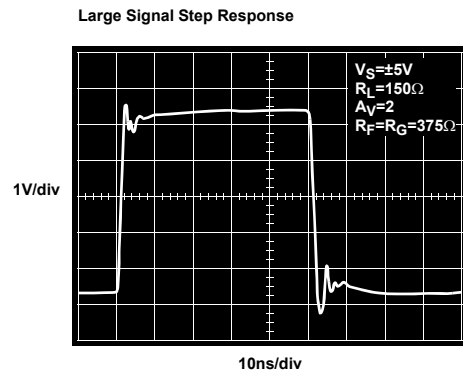
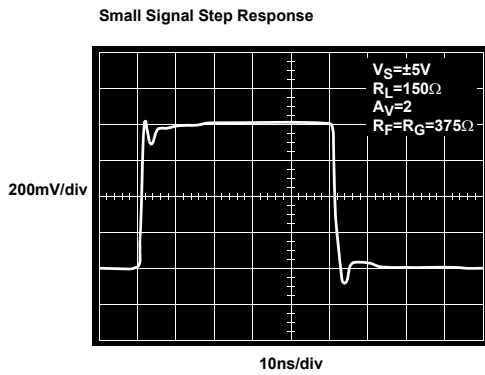
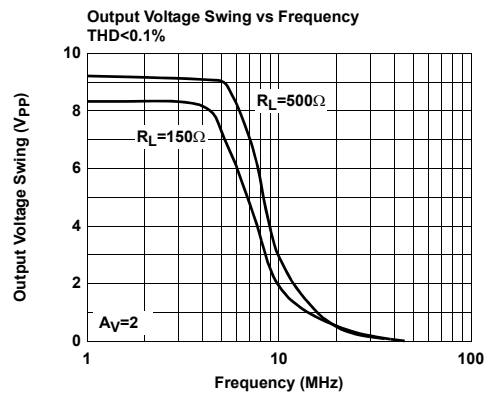
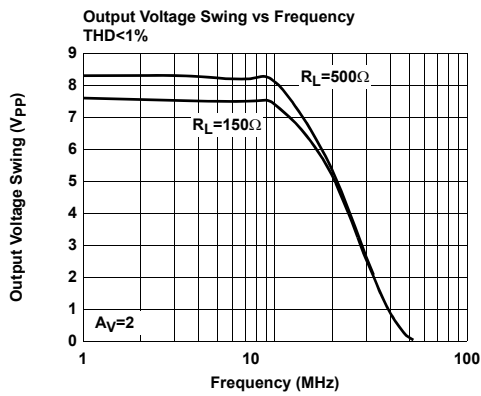
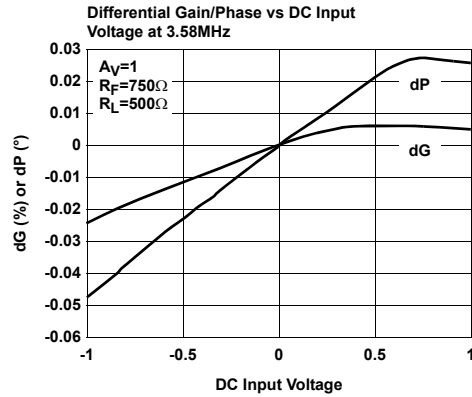
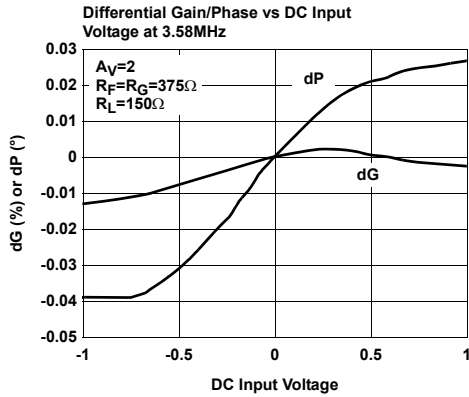

Typical Performance Curves (Continued)

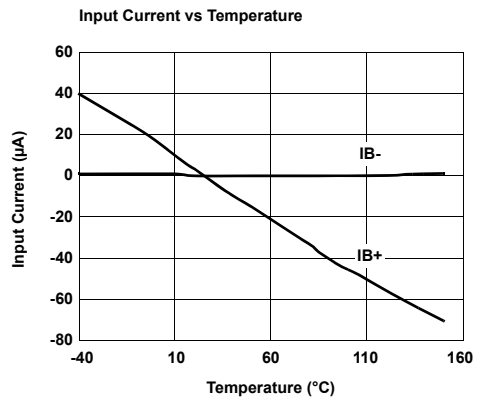
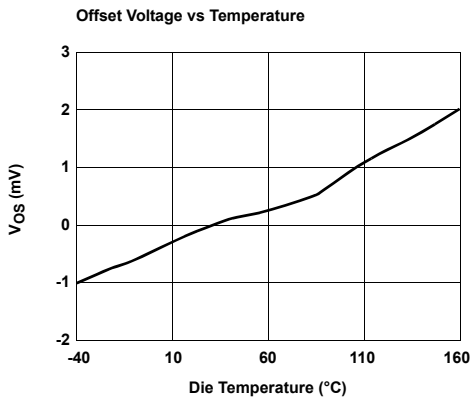
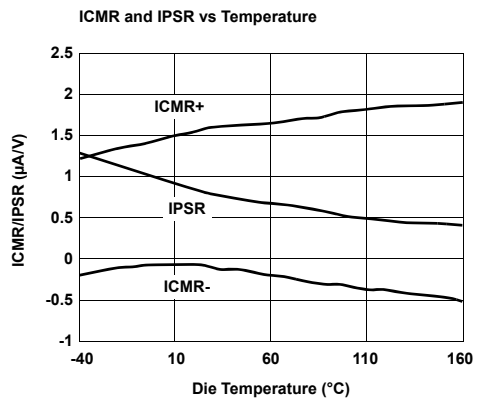
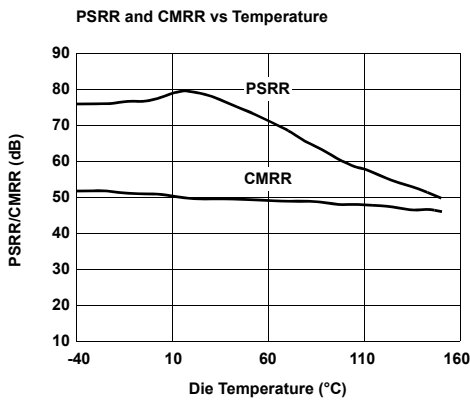
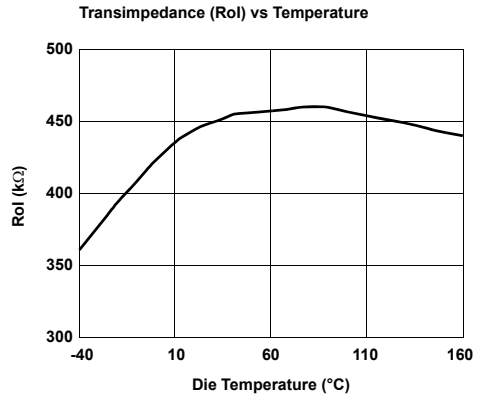
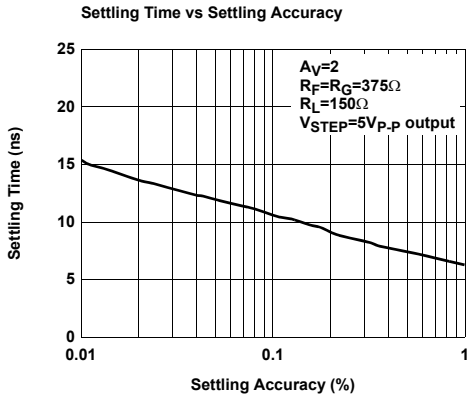

Typical Performance Curves (Continued)

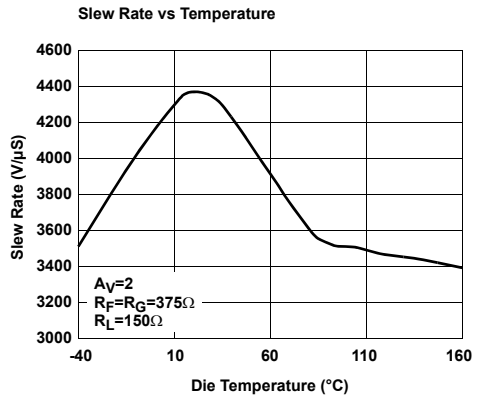
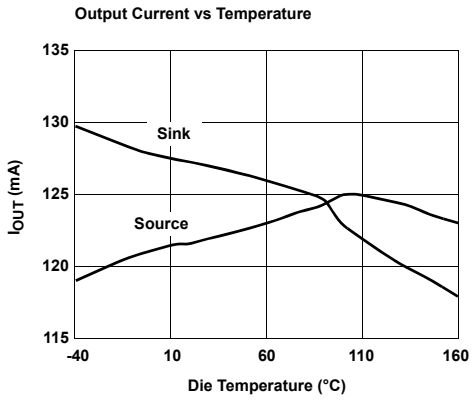
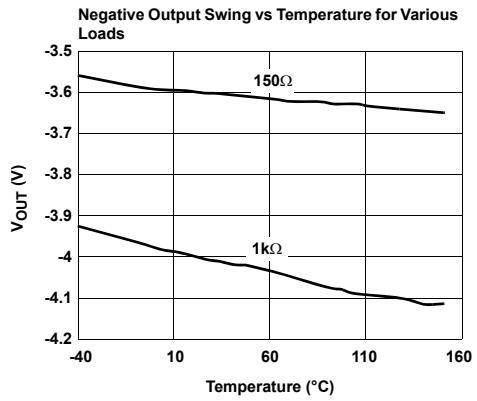
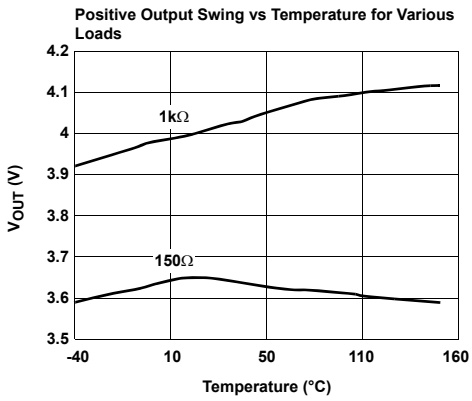
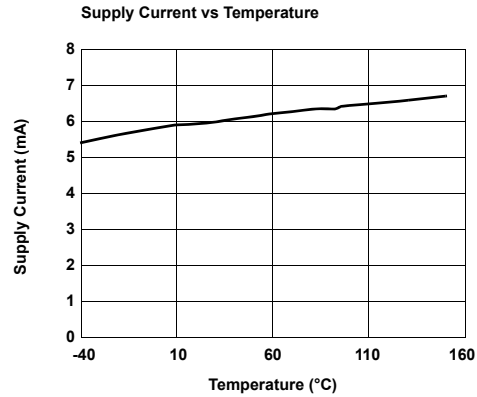
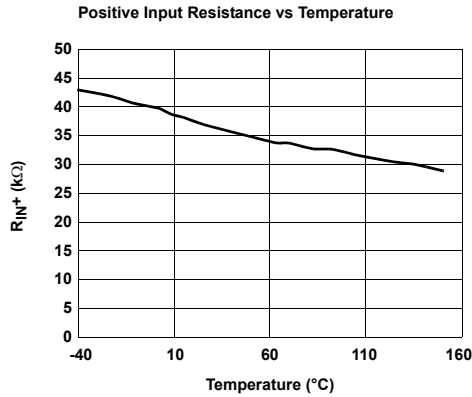

Typical Performance Curves (Continued)

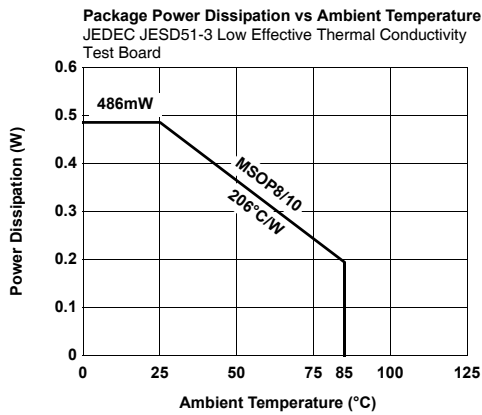
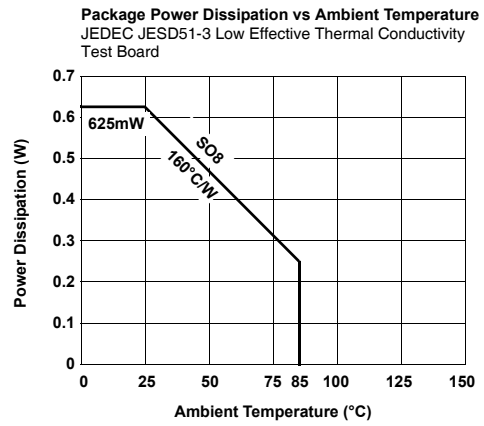
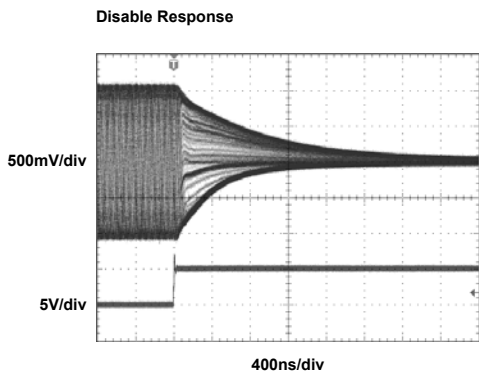
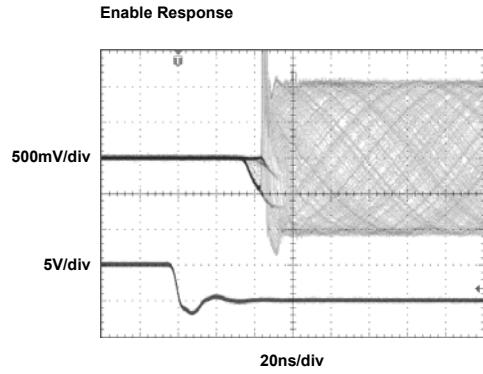
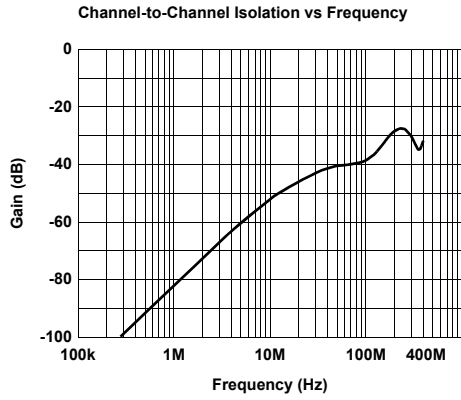

Pin Descriptions

8 LD SOIC/MSOP	10 LD MSOP	PIN NAME	FUNCTION	EQUIVALENT CIRCUIT
1	9	OUTA	Output, channel A	<p>Circuit 1</p>
2	10	INA-	Inverting input, channel A	<p>Circuit 2</p>
3	1	INA+	Non-inverting input, channel A	(see circuit 2)
	2	$\overline{\text{CEA}}$	Chip enable, channel A	<p>Circuit 3</p>
4	3	VS-	Negative supply	
	4	$\overline{\text{CEB}}$	Chip enable, channel B	(see circuit 3)
5	5	INB+	Non-inverting input, channel B	(see circuit 2)
6	6	INB-	Inverting input, channel B	(see circuit 2)
7	7	OUTB	Output, channel B	(see circuit 1)
8	8	VS+	Positive supply	

Applications Information

Product Description

The EL5292 is a current-feedback operational amplifier that offers a wide -3dB bandwidth of 600MHz and a low supply current of 6mA per amplifier. The EL5292 works with supply voltages ranging from a single 5V to 10V and they are also capable of swinging to within 1V of either supply on the output. Because of their current-feedback topology, the EL5292 does not have the normal gain-bandwidth product associated with voltage-feedback operational amplifiers. Instead, its -3dB bandwidth to remain relatively constant as closed-loop gain is increased. This combination of high bandwidth and low power, together with aggressive pricing make the EL5292 the ideal choice for many low-power/high-bandwidth applications such as portable, handheld, or battery-powered equipment.

For varying bandwidth needs, consider the EL5191 with 1GHz on a 9mA supply current or the EL5193 with 300MHz on a 4mA supply current. Versions include single, dual, and triple amp packages with 5 Ld SOT23, 16 Ld QSOP, and 8 Ld or 16 Ld SOIC outlines.

Power Supply Bypassing and Printed Circuit Board Layout

As with any high frequency device, good printed circuit board layout is necessary for optimum performance. Low impedance ground plane construction is essential. Surface mount components are recommended, but if leaded components are used, lead lengths should be as short as possible. The power supply pins must be well bypassed to reduce the risk of oscillation. The combination of a 4.7 μ F tantalum capacitor in parallel with a 0.01 μ F capacitor has been shown to work well when placed at each supply pin.

For good AC performance, parasitic capacitance should be kept to a minimum, especially at the inverting input. (See the Capacitance at the Inverting Input section) Even when ground plane construction is used, it should be removed from the area near the inverting input to minimize any stray capacitance at that node. Carbon or Metal-Film resistors are acceptable with the Metal-Film resistors giving slightly less peaking and bandwidth because of additional series inductance. Use of sockets, particularly for the SOIC package, should be avoided if possible. Sockets add parasitic inductance and capacitance which will result in additional peaking and overshoot.

Disable/Power-Down

The EL5292A amplifier can be disabled placing its output in a high impedance state. When disabled, the amplifier supply current is reduced to $< 300\mu\text{A}$. The EL5292A is disabled when its $\overline{\text{CE}}$ pin is pulled up to within 1V of the positive supply. Similarly, the amplifier is enabled by floating or pulling its $\overline{\text{CE}}$ pin to at least 3V below the positive supply. For $\pm 5\text{V}$ supply, this means that an EL5292A amplifier will be enabled when $\overline{\text{CE}}$ is 2V or less, and disabled when $\overline{\text{CE}}$ is above 4V. Although the logic levels are not standard TTL, this choice of logic voltages allows the EL5292A to be enabled by tying $\overline{\text{CE}}$ to ground, even in 5V single supply applications. The $\overline{\text{CE}}$ pin can be driven from CMOS outputs.

Capacitance at the Inverting Input

Any manufacturer's high-speed voltage- or current-feedback amplifier can be affected by stray capacitance at the inverting input. For inverting gains, this parasitic capacitance has little effect because the inverting input is a virtual ground, but for non-inverting gains, this capacitance (in conjunction with the feedback and gain resistors) creates a pole in the feedback path of the amplifier. This pole, if low enough in frequency, has the same destabilizing effect as a zero in the forward open-loop response. The use of large-value feedback and gain resistors exacerbates the problem by further lowering the pole frequency (increasing the possibility of oscillation.)

The EL5292 has been optimized with a 375Ω feedback resistor. With the high bandwidth of these amplifiers, these resistor values might cause stability problems when combined with parasitic capacitance, thus ground plane is not recommended around the inverting input pin of the amplifier.

Feedback Resistor Values

The EL5292 has been designed and specified at a gain of +2 with R_F approximately 375Ω . This value of feedback resistor gives 300MHz of -3dB bandwidth at $A_V = 2$ with 2dB of peaking. With $A_V = -2$, an R_F of 375Ω gives 275MHz of bandwidth with 1dB of peaking. Since the EL5292 is a current-feedback amplifier, it is also possible to change the value of R_F to get more bandwidth. As seen in the curve of Frequency Response for Various R_F and R_G , bandwidth and

peaking can be easily modified by varying the value of the feedback resistor.

Because the EL5292 is a current-feedback amplifier, its gain-bandwidth product is not a constant for different closed-loop gains. This feature actually allows the EL5292 to maintain about the same -3dB bandwidth. As gain is increased, bandwidth decreases slightly while stability increases. Since the loop stability is improving with higher closed-loop gains, it becomes possible to reduce the value of R_F below the specified 375Ω and still retain stability, resulting in only a slight loss of bandwidth with increased closed-loop gain.

Supply Voltage Range and Single-Supply Operation

The EL5292 has been designed to operate with supply voltages having a span of greater than 5V and less than 10V. In practical terms, this means that the EL5292 will operate on dual supplies ranging from $\pm 2.5\text{V}$ to $\pm 5\text{V}$. With single-supply, the EL5292 will operate from 5V to 10V.

As supply voltages continue to decrease, it becomes necessary to provide input and output voltage ranges that can get as close as possible to the supply voltages. The EL5292 has an input range which extends to within 2V of either supply. So, for example, on $\pm 5\text{V}$ supplies, the EL5292 has an input range which spans $\pm 3\text{V}$. The output range of the EL5292 is also quite large, extending to within 1V of the supply rail. On a $\pm 5\text{V}$ supply, the output is therefore capable of swinging from -4V to +4V. Single-supply output range is larger because of the increased negative swing due to the external pull-down resistor to ground.

Video Performance

For good video performance, an amplifier is required to maintain the same output impedance and the same frequency response as DC levels are changed at the output. This is especially difficult when driving a standard video load of 150Ω , because of the change in output current with DC level. Previously, good differential gain could only be achieved by running high idle currents through the output transistors (to reduce variations in output impedance.) These currents were typically comparable to the entire 6mA supply current of each EL5292 amplifier. Special circuitry has been incorporated in the EL5292 to reduce the variation of output impedance with current output. This results in dG and dP specifications of 0.015% and 0.04° , while driving 150Ω at a gain of 2.

Video performance has also been measured with a 500Ω load at a gain of +1. Under these conditions, the EL5292 has dG and dP specifications of 0.03% and 0.05° , respectively.

Output Drive Capability

In spite of its low 6mA of supply current, the EL5292 is capable of providing a minimum of $\pm 95\text{mA}$ of output current. With a minimum of $\pm 95\text{mA}$ of output drive, the EL5292 is

capable of driving 50Ω loads to both rails, making it an excellent choice for driving isolation transformers in telecommunications applications.

Driving Cables and Capacitive Loads

When used as a cable driver, double termination is always recommended for reflection-free performance. For those applications, the back-termination series resistor will decouple the EL5292 from the cable and allow extensive capacitive drive. However, other applications may have high capacitive loads without a back-termination resistor. In these applications, a small series resistor (usually between 5Ω and 50Ω) can be placed in series with the output to eliminate most peaking. The gain resistor (R_G) can then be chosen to make up for any gain loss which may be created by this additional resistor at the output. In many cases it is also possible to simply increase the value of the feedback resistor (R_F) to reduce the peaking.

Current Limiting

The EL5292 has no internal current-limiting circuitry. If the output is shorted, it is possible to exceed the Absolute Maximum Rating for output current or power dissipation, potentially resulting in the destruction of the device.

Power Dissipation

With the high output drive capability of the EL5292, it is possible to exceed the +125°C Absolute Maximum junction temperature under certain very high load current conditions. Generally speaking when R_L falls below about 25Ω, it is

important to calculate the maximum junction temperature (T_{JMAX}) for the application to determine if power supply voltages, load conditions, or package type need to be modified for the EL5292 to remain in the safe operating area. These parameters are calculated in Equation 1:

$$T_{JMAX} = T_{MAX} + (\theta_{JA} \times n \times PD_{MAX}) \quad (\text{EQ. 1})$$

where:

T_{MAX} = Maximum ambient temperature

θ_{JA} = Thermal resistance of the package

n = Number of amplifiers in the package

PD_{MAX} = Maximum power dissipation of each amplifier in the package

PD_{MAX} for each amplifier can be calculated in Equation 2:

$$PD_{MAX} = (2 \times V_S \times I_{SMAX}) + \left[(V_S - V_{OUTMAX}) \times \frac{V_{OUTMAX}}{R_L} \right] \quad (\text{EQ. 2})$$

where:

V_S = Supply voltage

I_{SMAX} = Maximum supply current of 1A

V_{OUTMAX} = Maximum output voltage (required)

R_L = Load resistance

Small Outline Package Family (SO)

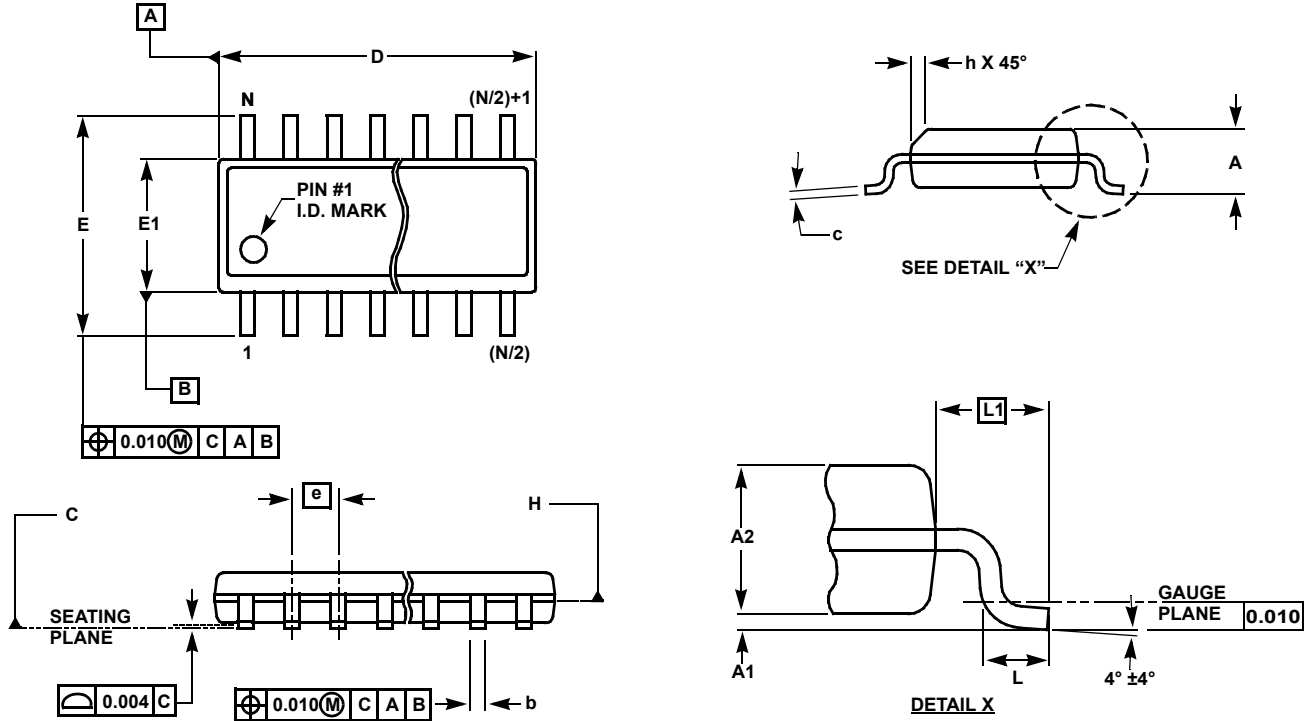

MDP0027

SMALL OUTLINE PACKAGE FAMILY (SO)

SYMBOL	INCHES							TOLERANCE	NOTES
	SO-8	SO-14	SO16 (0.150")	SO16 (0.300") (SOL-16)	SO20 (SOL-20)	SO24 (SOL-24)	SO28 (SOL-28)		
A	0.068	0.068	0.068	0.104	0.104	0.104	0.104	MAX	-
A1	0.006	0.006	0.006	0.007	0.007	0.007	0.007	±0.003	-
A2	0.057	0.057	0.057	0.092	0.092	0.092	0.092	±0.002	-
b	0.017	0.017	0.017	0.017	0.017	0.017	0.017	±0.003	-
c	0.009	0.009	0.009	0.011	0.011	0.011	0.011	±0.001	-
D	0.193	0.341	0.390	0.406	0.504	0.606	0.704	±0.004	1, 3
E	0.236	0.236	0.236	0.406	0.406	0.406	0.406	±0.008	-
E1	0.154	0.154	0.154	0.295	0.295	0.295	0.295	±0.004	2, 3
e	0.050	0.050	0.050	0.050	0.050	0.050	0.050	Basic	-
L	0.025	0.025	0.025	0.030	0.030	0.030	0.030	±0.009	-
L1	0.041	0.041	0.041	0.056	0.056	0.056	0.056	Basic	-
h	0.013	0.013	0.013	0.020	0.020	0.020	0.020	Reference	-
N	8	14	16	16	20	24	28	Reference	-

Rev. M 2/07

NOTES:

1. Plastic or metal protrusions of 0.006" maximum per side are not included.
2. Plastic interlead protrusions of 0.010" maximum per side are not included.
3. Dimensions "D" and "E1" are measured at Datum Plane "H".
4. Dimensioning and tolerancing per ASME Y14.5M-1994

Mini SO Package Family (MSOP)

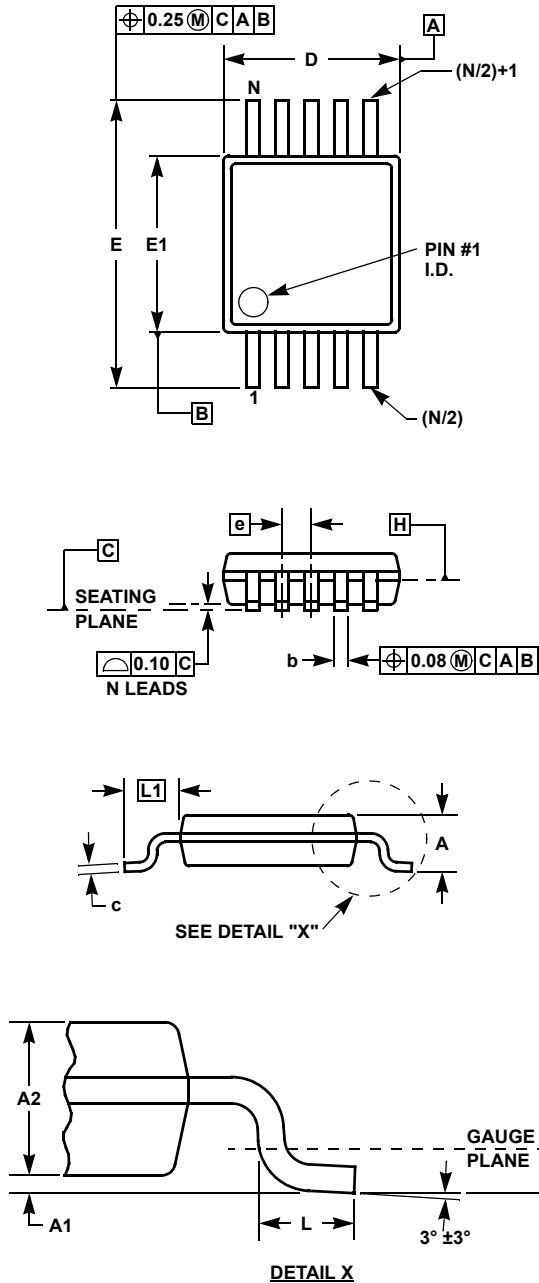

MDP0043 MINI SO PACKAGE FAMILY

SYMBOL	MILLIMETERS		TOLERANCE	NOTES
	MSOP8	MSOP10		
A	1.10	1.10	Max.	-
A1	0.10	0.10	± 0.05	-
A2	0.86	0.86	± 0.09	-
b	0.33	0.23	+0.07/-0.08	-
c	0.18	0.18	± 0.05	-
D	3.00	3.00	± 0.10	1, 3
E	4.90	4.90	± 0.15	-
E1	3.00	3.00	± 0.10	2, 3
e	0.65	0.50	Basic	-
L	0.55	0.55	± 0.15	-
L1	0.95	0.95	Basic	-
N	8	10	Reference	-

Rev. D 2/07

NOTES:

1. Plastic or metal protrusions of 0.15mm maximum per side are not included.
2. Plastic interlead protrusions of 0.25mm maximum per side are not included.
3. Dimensions "D" and "E1" are measured at Datum Plane "H".
4. Dimensioning and tolerancing per ASME Y14.5M-1994.

© Copyright Intersil Americas LLC 2004-2007. All Rights Reserved.
All trademarks and registered trademarks are the property of their respective owners.

For additional products, see www.intersil.com/en/products.html

Intersil products are manufactured, assembled and tested utilizing ISO9001 quality systems as noted in the quality certifications found at www.intersil.com/en/support/qualandreliability.html

Intersil products are sold by description only. Intersil may modify the circuit design and/or specifications of products at any time without notice, provided that such modification does not, in Intersil's sole judgment, affect the form, fit or function of the product. Accordingly, the reader is cautioned to verify that datasheets are current before placing orders. Information furnished by Intersil is believed to be accurate and reliable. However, no responsibility is assumed by Intersil or its subsidiaries for its use; nor for any infringements of patents or other rights of third parties which may result from its use. No license is granted by implication or otherwise under any patent or patent rights of Intersil or its subsidiaries.

For information regarding Intersil Corporation and its products, see www.intersil.com