

EL2386

250MHz Triple Current Feedback Amplifier with Disable

FN7155
Rev 1.00
June 24, 2004

The EL2386 is a triple current-feedback operational amplifier which achieves a -3dB bandwidth of 250MHz at a gain of +1 while consuming only 3mA of supply current per amplifier. It will operate with dual supplies ranging from $\pm 1.5V$ to $\pm 6V$, or from single supplies ranging from +3V to +12V. The EL2386 also includes a disable/power-down feature which reduces current consumption to 0mA while placing the amplifier output in a high impedance state. In spite of its low supply current, the EL2386 can output 55mA while swinging to $\pm 4V$ on $\pm 5V$ supplies. These attributes make the EL2386 an excellent choice for low power and/or low voltage cable-driver, HDSL, or RGB applications.

For single and dual applications, consider the EL2186/EL2286. For single, dual, and quad applications without disable, consider the EL2180, EL2280, or EL2480, all in industry-standard pinouts. The EL2180 also is available in the tiny SOT-23 package, which is 28% the size of an SO8 package. For lower power applications where speed is still a concern, consider the EL2170/EL2176 family which also comes in similar single, dual, and quad configurations. The EL2170/EL2176 family provides a -3dB bandwidth of 70MHz while consuming 1mA of supply current per amplifier.

Ordering Information

PART NUMBER	PACKAGE	TAPE & REEL	PKG. DWG. #
EL2386CS	16-Pin SO (0.150")	-	MDP0027
EL2386CS-T7	16-Pin SO (0.150")	7"	MDP0027
EL2386CS-T13	16-Pin SO (0.150")	13"	MDP0027
EL2386CSZ (Note)	16-Pin SO (0.150") (Pb-Free)	-	MDP0027
EL2386CSZ-T7 (Note)	16-Pin SO (0.150") (Pb-Free)	7"	MDP0027
EL2386CSZ-T13 (Note)	16-Pin SO (0.150") (Pb-Free)	13"	MDP0027

NOTE: Intersil Pb-free products employ special Pb-free material sets; molding compounds/die attach materials and 100% matte tin plate termination finish, which is compatible with both SnPb and Pb-free soldering operations. Intersil Pb-free products are MSL classified at Pb-free peak reflow temperatures that meet or exceed the Pb-free requirements of IPC/JEDEC J Std-020B.

Features

- Triple amplifier topology
- 3mA supply current (per amplifier)
- 250MHz -3dB bandwidth
- Low cost
- Fast disable
- Powers down to 0mA
- Single- and dual-supply operation down to $\pm 1.5V$
- 0.05%/0.05° diff. gain/diff. phase into 150 Ω
- 1200V/ μs slew rate
- Large output drive current: 55mA
- Available in single (EL2186) and dual (EL2286)
- Non power-down versions available in single, dual, and quad (EL2180, EL2280, EL2480)
- Lower power EL2170/EL2176 family also available (1mA/70MHz) in single, dual, and quad
- Pb-free available

Applications

- Low power/battery applications
- HDSL amplifiers
- Video amplifiers
- Cable drivers
- RGB amplifiers
- Test equipment amplifiers
- Current to voltage converters
- Multiplexing
- Video broadcast equipment

Pinout

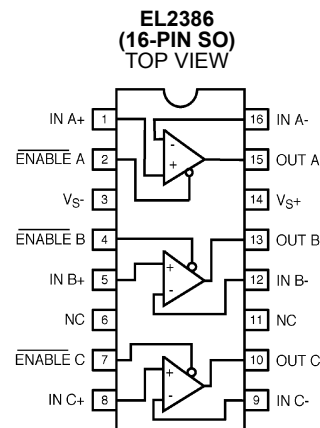

Absolute Maximum Ratings ($T_A = 25^\circ\text{C}$)

Voltage between V_{S+} and V_{S-} +12.6V
 Common-Mode Input Voltage V_{S-} to V_{S+}
 Differential Input Voltage $\pm 6\text{V}$
 Current into +IN or -IN $\pm 7.5\text{mA}$

Internal Power Dissipation See Curves
 Operating Ambient Temperature Range -40°C to $+85^\circ\text{C}$
 Operating Junction Temperature 150°C
 Output Current $\pm 60\text{mA}$

CAUTION: Stresses above those listed in "Absolute Maximum Ratings" may cause permanent damage to the device. This is a stress only rating and operation of the device at these or any other conditions above those indicated in the operational sections of this specification is not implied.

IMPORTANT NOTE: All parameters having Min/Max specifications are guaranteed. Typical values are for information purposes only. Unless otherwise noted, all tests are at the specified temperature and are pulsed tests, therefore: $T_J = T_C = T_A$

DC Electrical Specifications $V_S = \pm 5\text{V}$, $R_L = 150\Omega$, $\overline{\text{ENABLE}} = 0\text{V}$, $T_A = 25^\circ\text{C}$ unless otherwise specified.

PARAMETER	DESCRIPTION	CONDITIONS	MIN	TYP	MAX	UNIT
V_{OS}	Input Offset Voltage			2.5	15	mV
TCV_{OS}	Average Input Offset Voltage Drift	Measured from T_{MIN} to T_{MAX}		5		$\mu\text{V}/^\circ\text{C}$
dV_{OS}	V_{OS} Matching			0.5		mV
$+I_{IN}$	+Input Current			1.5	15	μA
$d+I_{IN}$	$+I_{IN}$ Matching			20		nA
$-I_{IN}$	-Input Current			16	40	μA
$d-I_{IN}$	$-I_{IN}$ Matching			2		μA
CMRR	Common Mode Rejection Ratio	$V_{CM} = \pm 3.5\text{V}$	45	50		dB
-ICMR	-Input Current Common Mode Rejection	$V_{CM} = \pm 3.5\text{V}$		5	30	$\mu\text{A}/\text{V}$
PSRR	Power Supply Rejection Ratio	$V_S = \pm 4\text{V}$ to $\pm 6\text{V}$	60	70		dB
-IPSR	-Input Current Power Supply Rejection	$V_S = \pm 4\text{V}$ to $\pm 6\text{V}$		1	15	$\mu\text{A}/\text{V}$
R_{OL}	Transimpedance	$V_{OUT} = \pm 2.5\text{V}$	120	300		$\text{k}\Omega$
$+R_{IN}$	+Input Resistance	$V_{CM} = \pm 3.5\text{V}$	0.5	2		$\text{M}\Omega$
$+C_{IN}$	+Input Capacitance			1.2		pF
CMIR	Common Mode Input Range		± 3.5	± 4.0		V
V_O	Output Voltage Swing	$V_S = \pm 5\text{V}$	± 3.5	± 4.0		V
		$V_S = +5\text{V}$ single-supply, high		4.0		V
		$V_S = +5\text{V}$ single-supply, low		0.3		V
I_O	Output Current		50	55		mA
I_S	Supply Current - Enabled (per amplifier)	$\overline{\text{ENABLE}} = 2.0\text{V}$		3	6	mA
$I_{S(DIS)}$	Supply Current - Disabled (per amplifier)	$\overline{\text{ENABLE}} = 4.5\text{V}$		0	50	μA
$C_{OUT(DIS)}$	Output Capacitance - Disabled	$\overline{\text{ENABLE}} = 4.5\text{V}$		4.4		pF
R_{IN-EN}	$\overline{\text{ENABLE}}$ Pin Input Resistance	$\overline{\text{ENABLE}} = 2.0\text{V}$ to 4.5V	45	85		$\text{k}\Omega$
I_{IH-EN}	$\overline{\text{ENABLE}}$ Pin Input Current - High	$\overline{\text{ENABLE}} = 4.5\text{V}$		-0.04		μA
I_{IL-EN}	$\overline{\text{ENABLE}}$ Pin Input Current - Low	$\overline{\text{ENABLE}} = 0\text{V}$		-53		μA
V_{DIS}	Minimum Voltage at $\overline{\text{ENABLE}}$ to Disable		4.5			V
V_{EN}	Maximum Voltage at $\overline{\text{ENABLE}}$ to Enable				2.0	V

AC Electrical Specifications $V_S = \pm 5V$, $R_F = R_G = 750\Omega$, $R_L = 150W$, $\overline{ENABLE} = 0V$, $T_A = 25^\circ C$ unless otherwise specified.

PARAMETER	DESCRIPTION	CONDITIONS	MIN	TYP	MAX	UNIT
BW	-3dB Bandwidth	$A_V = +1$		250		MHz
		$A_V = +2$		180		MHz
BW	± 0.1 dB Bandwidth	$A_V = +2$		50		MHz
SR	Slew Rate	$V_{OUT} = \pm 2.5V$, measured at $\pm 1.25V$	600	1200		V/ μs
t_R, t_F	Rise and Fall Time	$V_{OUT} = \pm 500mV$		1.5		ns
t_{PD}	Propagation Delay	$V_{OUT} = \pm 500mV$		1.5		ns
OS	Overshoot	$V_{OUT} = \pm 500mV$		3.0		%
t_S	0.1% Settling	$V_{OUT} = \pm 2.5V$, $A_V = -1$		15		ns
d_G	Differential Gain (Note 1)	$A_V = +2$, $R_L = 150\Omega$		0.05		%
d_P	Differential Phase (Note 1)	$A_V = +2$, $R_L = 150\Omega$		0.05		°
d_G	Differential Gain (Note 1)	$A_V = +1$, $R_L = 500\Omega$		0.01		%
d_P	Differential Phase (Note 1)	$A_V = +1$, $R_L = 500\Omega$		0.01		°
t_{ON}	Turn-On Time (Note 2)	$A_V = +2$, $V_{IN} = +1V$, $R_L = 150\Omega$		40	100	ns
t_{OFF}	Turn-Off Time (Note 2)	$A_V = +2$, $V_{IN} = +1V$, $R_L = 150\Omega$		800	2000	ns
C_S	Channel Separation	$f = 5MHz$		85		dB

NOTES:

- DC offset from 0V to 0.714V, AC amplitude 286mV_{p-p}, $f = 3.58MHz$.
- Measured from the application of the logic signal until the output voltage is at the 50% point between initial and final values.

Test Circuit (per Amplifier)

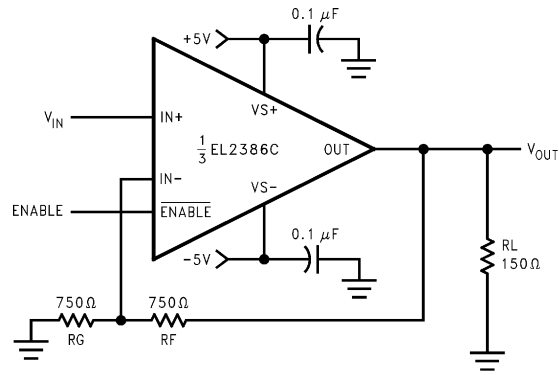

Simplified Schematic (per Amplifier)

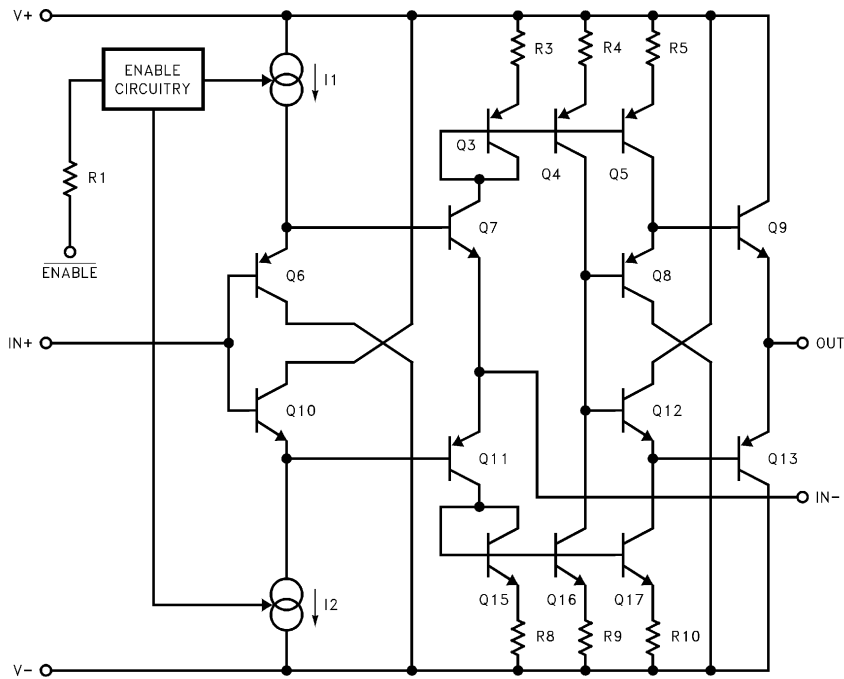

Typical Performance Curves

NON-INVERTING FREQUENCY RESPONSE (GAIN)

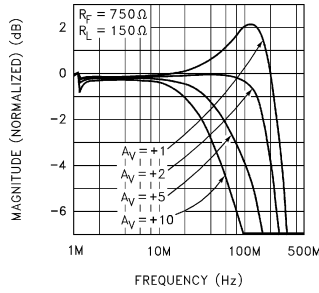

NON-INVERTING FREQUENCY RESPONSE (PHASE)

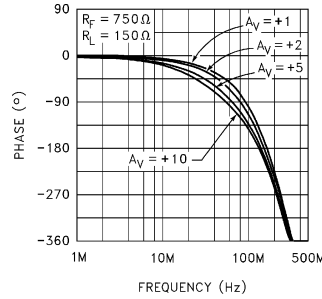

FREQUENCY RESPONSE FOR VARIOUS R_F AND R_G

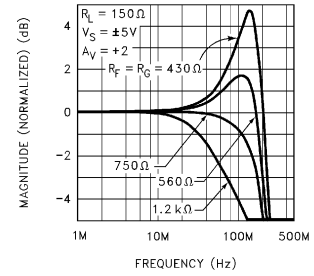

INVERTING FREQUENCY RESPONSE (GAIN)

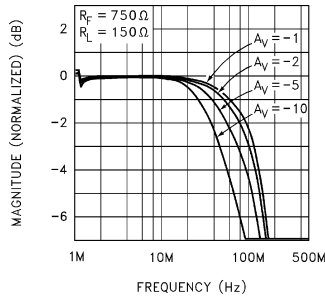

INVERTING FREQUENCY RESPONSE (PHASE)

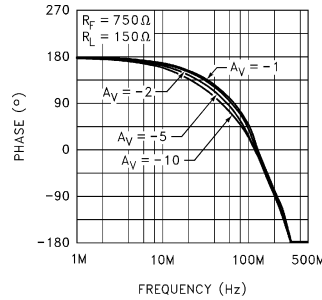

FREQUENCY RESPONSE FOR VARIOUS R_L AND C_L

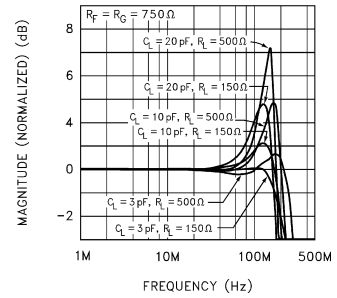

TRANSIMPEDANCE (R_{OL}) vs FREQUENCY

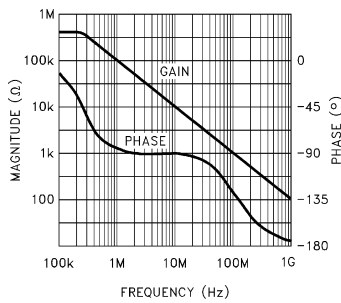

PSRR AND CMRR vs FREQUENCY

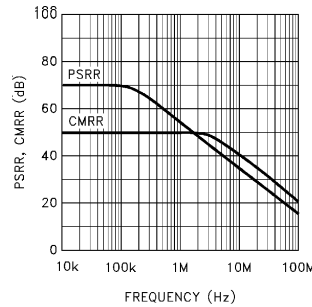

FREQUENCY RESPONSE FOR VARIOUS C_{IN-}

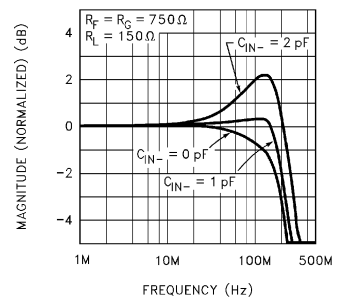

Typical Performance Curves (Continued)

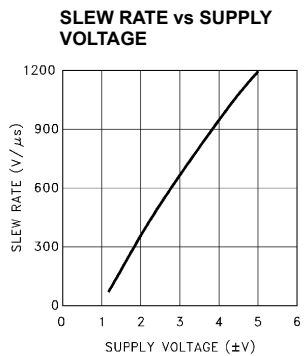
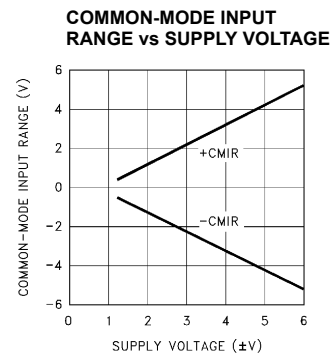
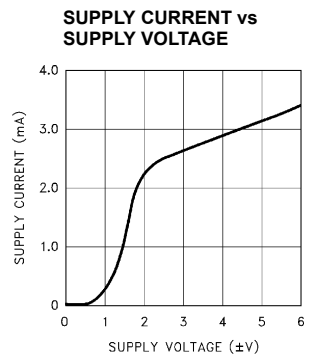
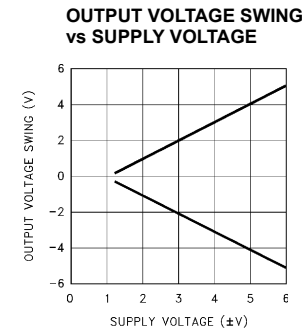
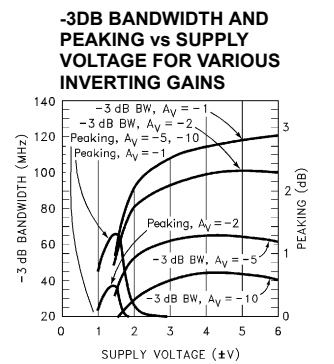
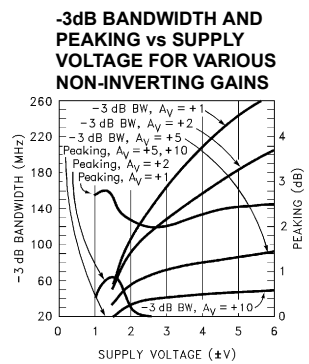
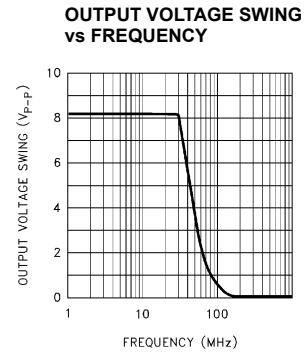
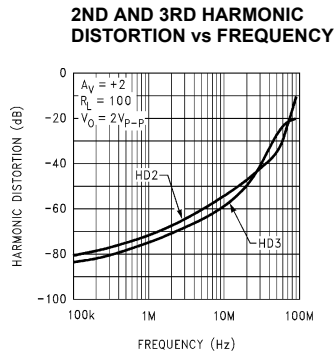
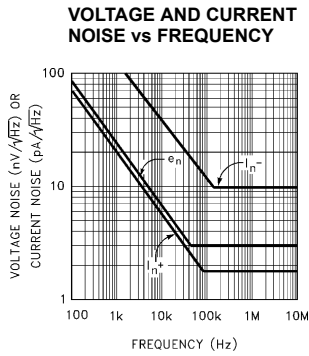

Typical Performance Curves (Continued)

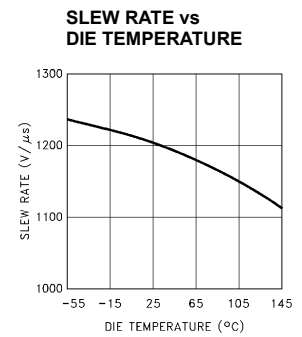
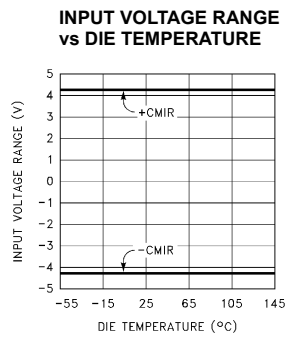
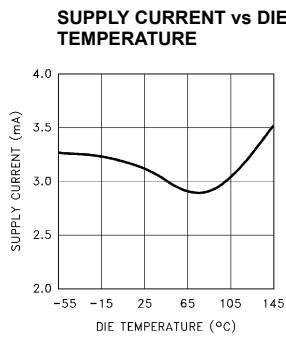
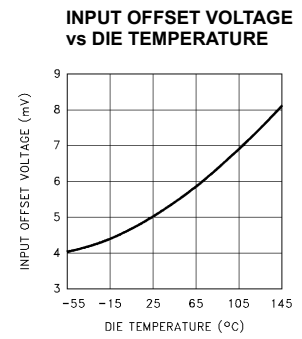
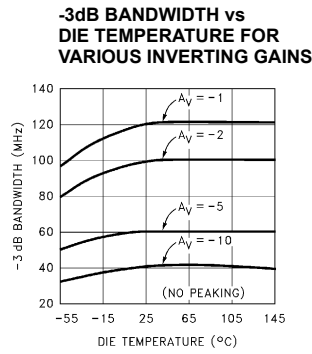
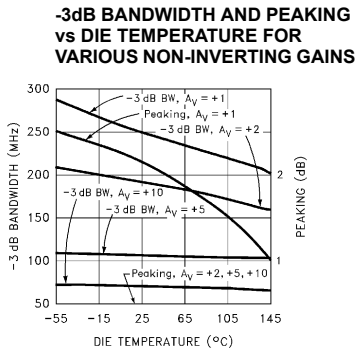
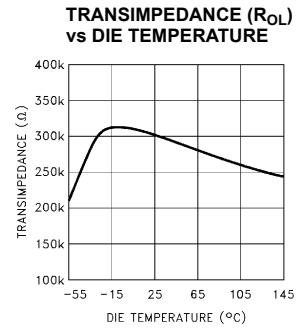
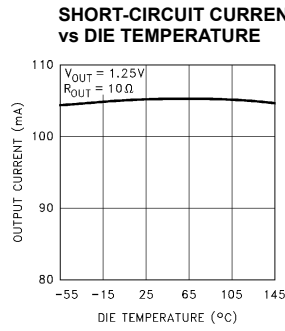
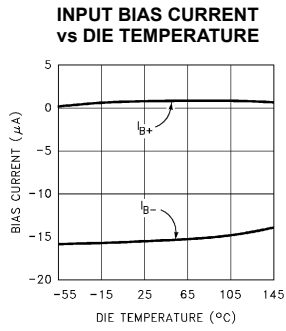

Typical Performance Curves (Continued)

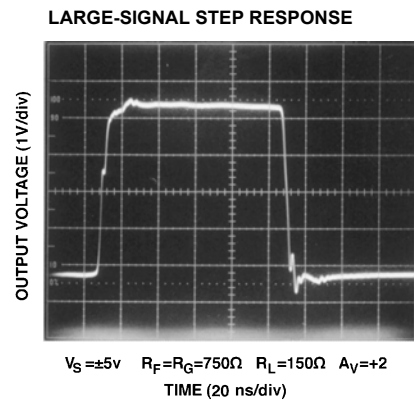
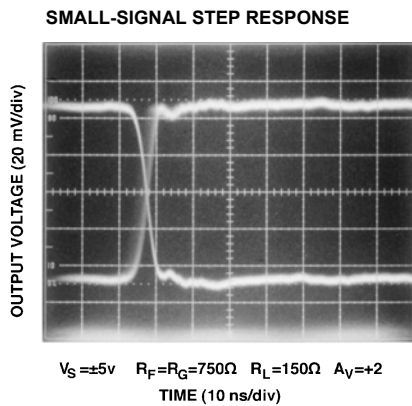
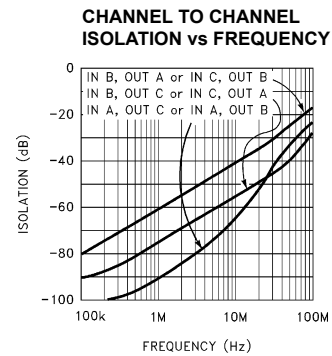
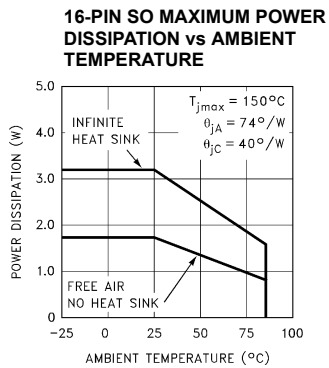
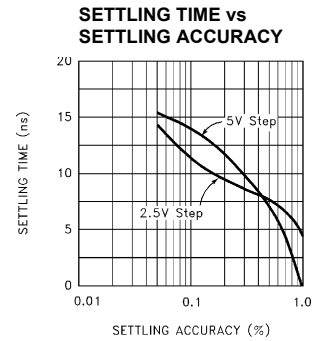
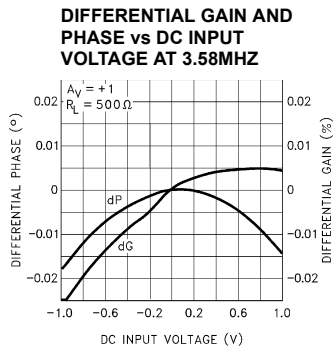
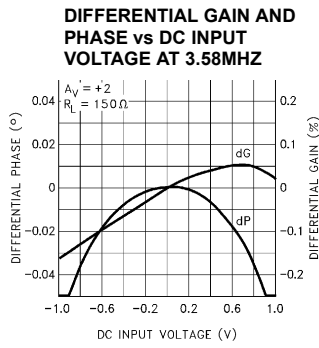

Applications Information

Product Description

The EL2386 is a current-feedback operational amplifier that offers a wide -3dB bandwidth of 250MHz, a low supply current of 3mA per amplifier and the ability to power down to 0mA. It also features high output current drive. The EL2386 can output 55mA per amplifier. The EL2386 works with supply voltages ranging from a single 3V to $\pm 6V$, and it is also capable of swinging to within 1V of either supply on the input and the output. Because of its current-feedback topology, the EL2386 does not have the normal gain-bandwidth product associated with voltage-feedback operational amplifiers. This allows its -3dB bandwidth to remain relatively constant as closed-loop gain is increased. This combination of high bandwidth and low power, together with aggressive pricing make the EL2386 the ideal choice for many low-power/high-bandwidth applications such as portable computing, HDSL, and video processing.

For single and dual applications, consider the EL2186/EL2286. For single, dual and quad applications without disable, consider the EL2180, EL2280, or EL2480, all in industry standard pin outs. The EL2180 also is available in the tiny SOT-23 package, which is 28% the size of an SO8 package. For lower power applications where speed is still a concern, consider the EL2170/EL2176 family which also comes in similar single, dual and quad configurations with 70MHz of bandwidth while consuming 1mA of supply current per amplifier.

Power Supply Bypassing and Printed Circuit Board Layout

As with any high-frequency device, good printed circuit board layout is necessary for optimum performance. Ground plane construction is highly recommended. Pin lengths should be as short as possible. The power supply pins must be well bypassed to reduce the risk of oscillation. The combination of a 4.7 μ F tantalum capacitor in parallel with a 0.1 μ F capacitor has been shown to work well when placed at each supply pin. For single supply operation, where pin 3 (V_{S-}) is connected to the ground plane, a single 4.7 μ F tantalum capacitor in parallel with a 0.1 μ F ceramic capacitor across pins 14 and 3 will suffice.

For good AC performance, parasitic capacitance should be kept to a minimum especially at the inverting input (see the Capacitance at the Inverting Input section). Ground plane construction should be used, but it should be removed from the area near the inverting input to minimize any stray capacitance at that node. Carbon or Metal-Film resistors are acceptable with the Metal-Film resistors giving slightly less peaking and bandwidth because of their additional series inductance. Use of sockets, particularly for the SO package should be avoided if possible. Sockets add parasitic inductance and capacitance which will result in some additional peaking and overshoot.

Disable/Power-Down

The EL2386 amplifier can be disabled, placing its output in a high-impedance state. When disabled, the supply current is reduced to 0mA. The EL2386 is disabled when its $\overline{\text{ENABLE}}$ pin is floating or pulled up to within 0.5V of the positive supply. Similarly, the amplifier is enabled by pulling its $\overline{\text{ENABLE}}$ pin at least 3V below the positive supply. For $\pm 5V$ supplies, this means that an EL2386 amplifier will be enabled when $\overline{\text{ENABLE}}$ is at 2V or less, and disabled when $\overline{\text{ENABLE}}$ is above 4.5V. Although the logic levels are not standard TTL, this choice of logic voltages allows the EL2386 to be enabled by tying $\overline{\text{ENABLE}}$ to ground, even in +3V single-supply applications. The $\overline{\text{ENABLE}}$ pin can be driven from CMOS outputs or open-collector TTL.

When enabled, supply current does vary somewhat with the voltage applied at $\overline{\text{ENABLE}}$. For example, with the supply voltages of the EL2186 at $\pm 5V$, if $\overline{\text{ENABLE}}$ is tied to -5V (rather than ground) the supply current will increase about 15% to 3.45mA.

Capacitance at the Inverting Input

Any manufacturer's high-speed voltage- or current-feedback amplifier can be affected by stray capacitance at the inverting input. For inverting gains this parasitic capacitance has little effect because the inverting input is a virtual ground, but for non-inverting gains this capacitance (in conjunction with the feedback and gain resistors) creates a pole in the feedback path of the amplifier. This pole, if low enough in frequency, has the same destabilizing effect as a zero in the forward open-loop response. The use of large value feedback and gain resistors further exacerbates the problem by further lowering the pole frequency.

The experienced user with a large amount of PC board layout experience may find in rare cases that the EL2386 has less bandwidth than expected. In this case, the inverting input may have less parasitic capacitance than expected. The reduction of feedback resistor values (or the addition of a very small amount of external capacitance at the inverting input, e. g. 0.5pF) will increase bandwidth as desired. Please see the curves for Frequency Response for Various R_F and R_G , and Frequency Response for Various C_{IN} .

Feedback Resistor Values

The EL2386 has been designed and specified at gains of +1 and +2 with $R_F = 750\Omega$. This value of feedback resistor gives 250MHz of -3dB bandwidth at $A_V = +1$ with about 2.5dB of peaking, and 180MHz of -3dB bandwidth at $A_V = +2$ with about 0.1dB of peaking. Since the EL2386 is a current-feedback amplifier, it is also possible to change the value of R_F to get more bandwidth. As seen in the curve of Frequency Response For Various R_F and R_G , bandwidth and peaking can be easily modified by varying the value of the feedback resistor.

Because the EL2386 is a current-feedback amplifier, its gain-bandwidth product is not a constant for different closed-loop gains. This feature actually allows the EL2386 to maintain

about the same -3dB bandwidth, regardless of closed-loop gain. However, as closed-loop gain is increased, bandwidth decreases slightly while stability increases. Since the loop stability is improving with higher closed-loop gains, it becomes possible to reduce the value of R_F below the specified 750Ω and still retain stability, resulting in only a slight loss of bandwidth with increased closed-loop gain.

Supply Voltage Range and Single-Supply Operation

The EL2386 has been designed to operate with supply voltages having a span of greater than 3V, and less than 12V. In practical terms, this means that the EL2386 will operate on dual supplies ranging from $\pm 1.5V$ to $\pm 6V$. With a single-supply, the EL2386 will operate from +3V to +12V.

As supply voltages continue to decrease, it becomes necessary to provide input and output voltage ranges that can get as close as possible to the supply voltages. The EL2386 has an input voltage range that extends to within 1V of either supply. So, for example, on a single +5V supply, the EL2386 has an input range which spans from 1V to 4V. The output range of the EL2386 is also quite large, extending to within 1V of the supply rail. On a $\pm 5V$ supply, the output is therefore capable of swinging from -4V to +4V. Single-supply output range is even larger because of the increased negative swing due to the external pull-down resistor to ground. On a single +5V supply, output voltage range is about 0.3V to 4V.

Video Performance

For good video performance, an amplifier is required to maintain the same output impedance and the same frequency response as DC levels are changed at the output. This is especially difficult when driving a standard video load of 150Ω , because of the change in output current with DC level. Until the EL2386, good Differential Gain could only be achieved by running high idle currents through the output transistors (to reduce variations in output impedance). These currents were typically comparable to the entire 3mA supply current of each EL2386 amplifier! Special circuitry has been incorporated in the EL2386 to reduce the variation of output impedance with current output. This results in d_G and d_P specifications of 0.05% and 0.05° while driving 150Ω at a gain of +2.

Video Performance has also been measured with a 500Ω load at a gain of +1. Under these conditions, the EL2386 has d_G and d_P specifications of 0.01% and 0.01° respectively while driving 500Ω at $A_V = +1$.

For complete curves, see the Differential Gain and Differential Phase vs Input Voltage curves.

Output Drive Capability

In spite of its low 3mA of supply current per amplifier, the EL2386 is capable of providing a minimum of $\pm 50mA$ of output current. This output drive level is unprecedented in amplifiers running at these supply currents. With a minimum $\pm 50mA$ of output drive, the EL2386 is capable of driving 50Ω loads to

$\pm 2.5V$, making it an excellent choice for driving multiple video loads in RGB applications.

Driving Cables and Capacitive Loads

When used as a cable driver, double termination is always recommended for reflection-free performance. For those applications, the back-termination series resistor will decouple the EL2386 from the cable and allow extensive capacitive drive. However, other applications may have high capacitive loads without a back-termination resistor. In these applications, a small series resistor (usually between 5Ω and 50Ω) can be placed in series with the output to eliminate most peaking. The gain resistor (R_G) can then be chosen to make up for any gain loss which may be created by this additional resistor at the output. In many cases it is also possible to simply increase the value of the feedback resistor (R_F) to reduce the peaking.

Current Limiting

The EL2386 has no internal current-limiting circuitry. If an output is shorted indefinitely, the power dissipation could easily increase such that the part will be destroyed. Maximum reliability is maintained if the output current never exceeds $\pm 60mA$. A heat sink may be required to keep the junction temperature below absolute maximum when an output is shorted indefinitely.

Multiplexing with the EL2386

The ENABLE pins on the EL2386 allow for multiplexing applications. Figure 1 shows an EL2386 with all 3 outputs tied together, driving a back terminated 75Ω video load. Three sine waves of varying amplitudes and frequencies are applied to the three inputs, while a 1 of 3 decoder selects one amplifier to be on at any given time. Figure 2 shows the resulting output wave form at V_{OUT} . Switching is complete in about 100ns. Notice the outputs are tied directly together. De-coupling resistors at each output are not required or advised when multiplexing.

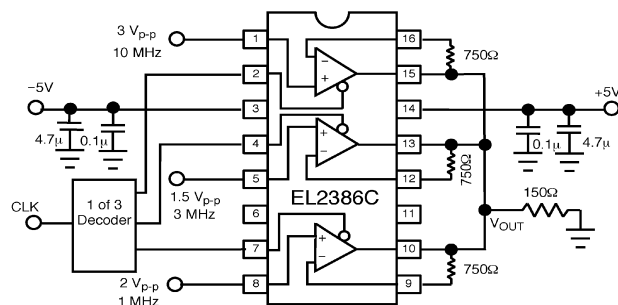

FIGURE 1.

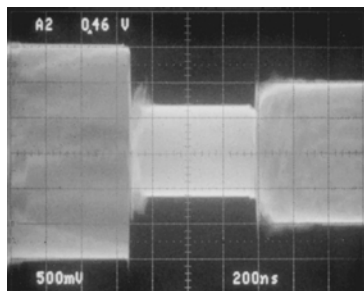

FIGURE 2.

Power Dissipation

With the high output drive capability of the EL2386, it is possible to exceed the 150°C Absolute Maximum junction temperature under certain very high load current conditions. Generally speaking, when R_L falls below about 25Ω, it is important to calculate the maximum junction temperature (T_{JMAX}) for the application to determine if power-supply voltages, load conditions, or package type need to be modified for the EL2386 to remain in the safe operating area.

These parameters are calculated as follows:

$$T_{JMAX} = T_{MAX} + (\theta_{JA} * n * PD_{MAX})$$

where:

T_{MAX} = Maximum ambient temperature

θ_{JA} = Thermal resistance of the package

n = Number of amplifiers in the package

PD_{MAX} = Maximum power dissipation of each amplifier in the package

PD_{MAX} for each amplifier can be calculated as follows:

$$PD_{MAX} = (2 * V_S * I_{SMAX}) + ((V_S) - V_{OUTMAX}) * (V_{OUTMAX} / R_L)$$

where:

V_S = Supply voltage

I_{SMAX} = Maximum supply current of 1 amplifier

V_{OUTMAX} = Max. output voltage of the application

R_L = Load resistance

EL2386 Macromodel (Continued)

* Error Terms

*

ivos 0 23 0.2mA

vxx 23 0 0V

e4 24 0 3 0 1.0

e5 25 0 7 0 1.0

e6 26 0 4 0 -1.0

r9 24 23 316

r10 25 23 3.2K

r11 26 23 3.2K

*

* Models

*

.model qn npn(is=5e-15 bf=200 tf=0.1nS)

.model qp pnp(is=5e-15 bf=200 tf=0.1nS)

.model dclamp d(is=1e-30 ibv=0.266

+ bv=0.71v n=4)

.ends

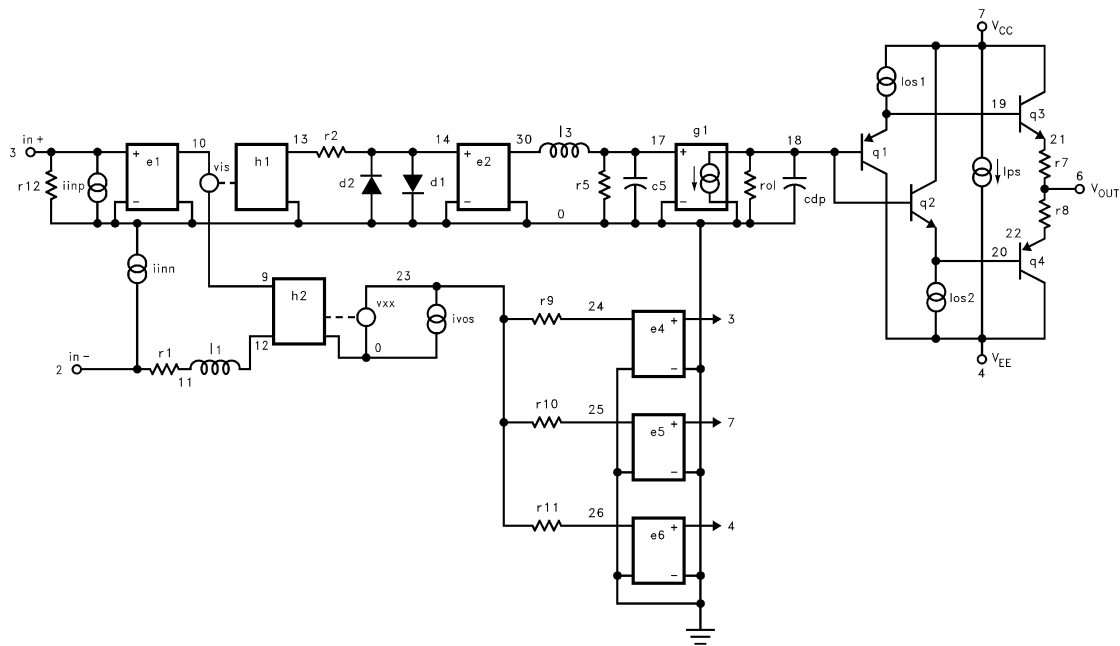

© Copyright Intersil Americas LLC 2004. All Rights Reserved.

All trademarks and registered trademarks are the property of their respective owners.

For additional products, see www.intersil.com/en/products.html

Intersil products are manufactured, assembled and tested utilizing ISO9001 quality systems as noted in the quality certifications found at www.intersil.com/en/support/qualandreliability.html

Intersil products are sold by description only. Intersil may modify the circuit design and/or specifications of products at any time without notice, provided that such modification does not, in Intersil's sole judgment, affect the form, fit or function of the product. Accordingly, the reader is cautioned to verify that datasheets are current before placing orders. Information furnished by Intersil is believed to be accurate and reliable. However, no responsibility is assumed by Intersil or its subsidiaries for its use; nor for any infringements of patents or other rights of third parties which may result from its use. No license is granted by implication or otherwise under any patent or patent rights of Intersil or its subsidiaries.

For information regarding Intersil Corporation and its products, see www.intersil.com