

## EL1519

### Medium Power Differential Line Driver

FN7017  
Rev 2.00  
April 10, 2007

The EL1519 is a dual operational amplifier designed for customer premise line driving in DMT ADSL solutions. This device features a high drive capability of 250mA while consuming only 7.1mA of supply current per amplifier and operating from a single 5V to 12V supply. This driver achieves a typical distortion of less than -85dBc, at 150kHz into a 25Ω load. The EL1519 is available in the industry standard 8 Ld SO. This device is optimized to use low feedback resistor values to minimize noise in ADSL systems.

The EL1519 is ideal for ADSL, SDSL, HDSL2 and VDSL line driving applications.

### Ordering Information

| PART NUMBER                 | PART MARKING | TAPE & REEL | PACKAGE              | PKG. DWG. # |
|-----------------------------|--------------|-------------|----------------------|-------------|
| EL1519CS                    | 1519CS       | -           | 8 Ld SO              | MDP0027     |
| EL1519CS-T7                 | 1519CS       | 7"          | 8 Ld SO              | MDP0027     |
| EL1519CS-T13                | 1519CS       | 13"         | 8 Ld SO              | MDP0027     |
| EL1519CSZ<br>(See Note)     | 1519CSZ      | -           | 8 Ld SO<br>(Pb-Free) | MDP0027     |
| EL1519CSZ-T7<br>(See Note)  | 1519CSZ      | 7"          | 8 Ld SO<br>(Pb-Free) | MDP0027     |
| EL1519CSZ-T13<br>(See Note) | 1519CSZ      | 13"         | 8 Ld SO<br>(Pb-Free) | MDP0027     |

NOTE: Intersil Pb-free plus anneal products employ special Pb-free material sets; molding compounds/die attach materials and 100% matte tin plate termination finish, which are RoHS compliant and compatible with both SnPb and Pb-free soldering operations. Intersil Pb-free products are MSL classified at Pb-free peak reflow temperatures that meet or exceed the Pb-free requirements of IPC/JEDEC J STD-020.

### Features

- Drives up to 250mA from a +12V supply
- 20V<sub>P-P</sub> differential output drive into 100Ω
- -85dBc typical driver output distortion at full output at 150kHz
- Low quiescent current of 7.5mA per amplifier
- Pb-Free Plus Anneal Available (RoHS Compliant)

### Applications

- ADSL G.lite CO line driving
- ADSL full rate CPE line driving
- G.SHDSL, HDSL2 line driver
- Video distribution amplifier
- Video twisted-pair line driver

### Pinout

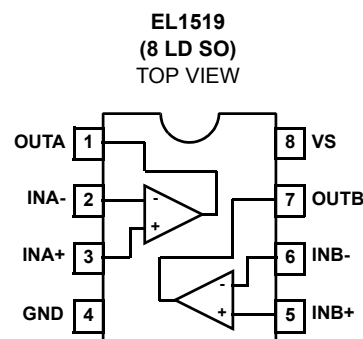

**Absolute Maximum Ratings** ( $T_A = +25^\circ\text{C}$ )

|                            |                 |
|----------------------------|-----------------|
| $V_{S+}$ Voltage to Ground | -0.3V to +14.6V |
| $V_{IN+}$ Voltage          | GND to $V_{S+}$ |
| Current into any Input     | 8mA             |
| Continuous Output Current  | 75mA            |

**Thermal Information**

|                                |                 |
|--------------------------------|-----------------|
| Operating Temperature Range    | -40°C to +85°C  |
| Storage Temperature Range      | -60°C to +150°C |
| Operating Junction Temperature | -40°C to +150°C |
| Power Dissipation              | See Curves      |

CAUTION: Stresses above those listed in "Absolute Maximum Ratings" may cause permanent damage to the device. This is a stress only rating and operation of the device at these or any other conditions above those indicated in the operational sections of this specification is not implied.

IMPORTANT NOTE: All parameters having Min/Max specifications are guaranteed. Typical values are for information purposes only. Unless otherwise noted, all tests are at the specified temperature and are pulsed tests, therefore:  $T_J = T_C = T_A$

**Electrical Specifications**  $V_S = \pm 12\text{V}$ ,  $R_F = 750\Omega$ ,  $R_L = 100\Omega$  connected to mid supply,  $T_A = +25^\circ\text{C}$ . Unless otherwise specified.

| PARAMETER                     | DESCRIPTION                        | CONDITIONS   | MIN       | TYP       | MAX | UNIT                   |
|-------------------------------|------------------------------------|--|-----------|-----------|-----|------------------------|
| <b>AC PERFORMANCE</b>         |                                    |  |           |           |     |                        |
| BW                            | -3dB Bandwidth                     | $A_V = +4$   |           | 70        |     | MHz                    |
| HD                            | Total Harmonic Distortion          | $f = 150\text{kHz}$ , $V_O = 16\text{Vp-p}$ , $R_L = 25\Omega$ |           | -85       |     | dBc                    |
| dG                            | Differential Gain                  | $A_V = +2$ , $R_L = 37.5\Omega$                                |           | 0.15      |     | %                      |
| d $\theta$                    | Differential Phase                 | $A_V = +2$ , $R_L = 37.5\Omega$                                |           | 0.1       |     | °                      |
| SR                            | Slewrate                           | $V_{OUT}$ from -3V to +3V                                      | 275       | 350       |     | V/ $\mu\text{s}$       |
| <b>DC PERFORMANCE</b>         |                                    |  |           |           |     |                        |
| $V_{OS}$                      | Offset Voltage                     |  | -20       |           | 20  | mV                     |
| $\Delta V_{OS}$               | $V_{OS}$ Mismatch                  |  | -10       |           | 10  | mV                     |
| $R_{OL}$                      | Transimpedance                     | $V_{OUT}$ from -4.5V to +4.5V                                  | 0.7       | 1.4       | 2.5 | M $\Omega$             |
| <b>INPUT CHARACTERISTICS</b>  |                                    |  |           |           |     |                        |
| $I_{B+}$                      | Non-Inverting Input Bias Current   |  | -3        |           | 3   | $\mu\text{A}$          |
| $I_{B-}$                      | Inverting Input Bias Current       |  | -30       |           | 30  | $\mu\text{A}$          |
| $e_N$                         | Input Noise Voltage                |  |           | 2.7       |     | nV/ $\sqrt{\text{Hz}}$ |
| $i_N$                         | -Input Noise Current               |  |           | 18        |     | pA/ $\sqrt{\text{Hz}}$ |
| <b>OUTPUT CHARACTERISTICS</b> |                                    |  |           |           |     |                        |
| $V_{OUT}$                     | Loaded Output Swing (single ended) | $R_L = 100\Omega$ to GND, $V_S = \pm 6\text{V}$                | $\pm 4.8$ | $\pm 5$   |     | V                      |
|                               |                                    | $R_L = 25\Omega$ to GND, $V_S = \pm 6\text{V}$                 | $\pm 4.4$ | $\pm 4.7$ |     | V                      |
| $I_{OUT}$                     | Output Current                     | $R_L = 0\Omega$  |           | 450       |     | mA                     |
| <b>SUPPLY</b>                 |                                    |  |           |           |     |                        |
| $V_S$                         | Supply Voltage                     | Single Supply  | 5         |           | 12  | V                      |
| $I_S$                         | Supply Current                     | All Outputs at Mid Supply                                      |           | 14.2      | 18  | mA                     |

Typical Performance Curves

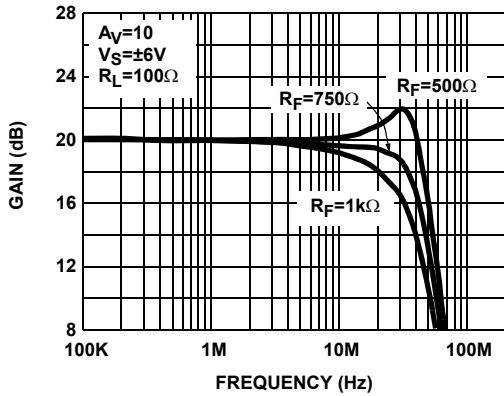

FIGURE 1. DIFFERENTIAL FREQUENCY RESPONSE vs  $R_F$

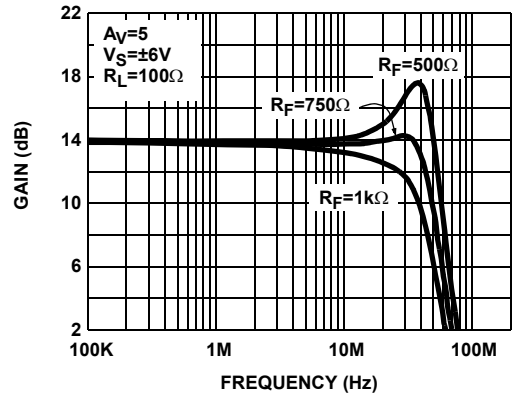

FIGURE 2. DIFFERENTIAL FREQUENCY RESPONSE vs  $R_F$

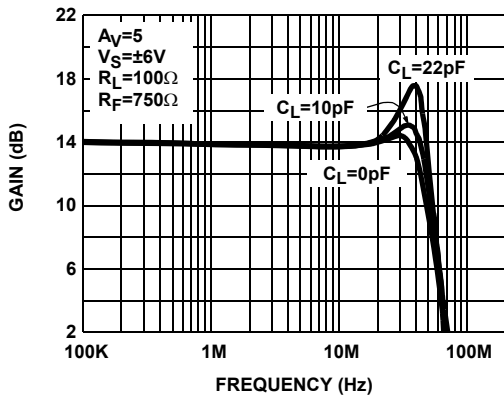

FIGURE 3. DIFFERENTIAL FREQUENCY RESPONSE vs  $C_L$

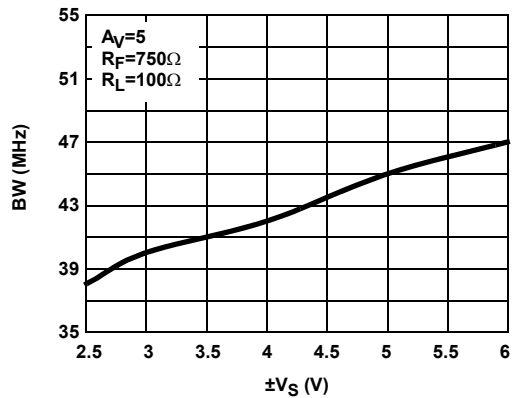

FIGURE 4. DIFFERENTIAL BANDWIDTH vs SUPPLY VOLTAGE

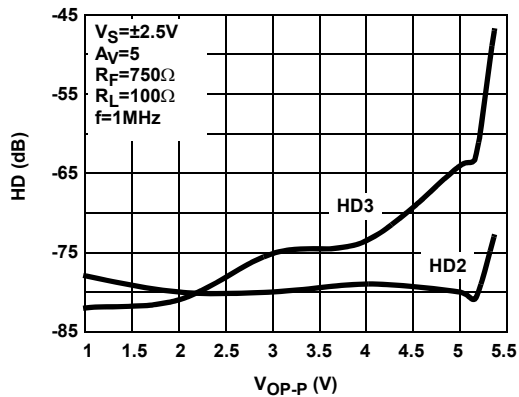

FIGURE 5. DIFFERENTIAL HARMONIC DISTORTION vs DIFFERENTIAL OUTPUT VOLTAGE

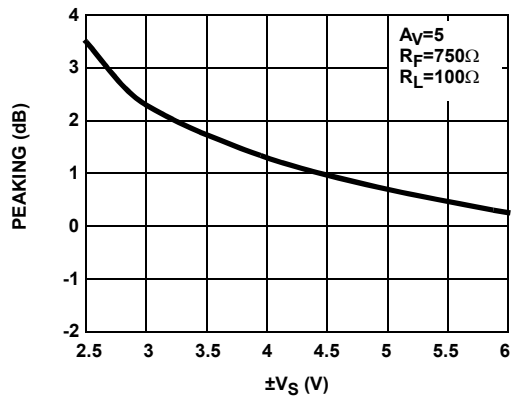

FIGURE 6. DIFFERENTIAL PEAKING vs SUPPLY VOLTAGE

Typical Performance Curves

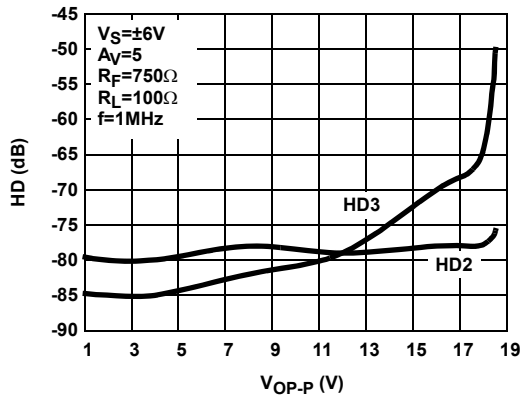

FIGURE 7. DIFFERENTIAL HARMONIC DISTORTION vs DIFFERENTIAL OUTPUT VOLTAGE

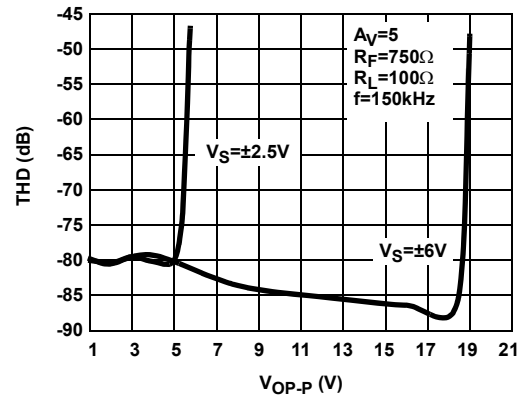

FIGURE 8. DIFFERENTIAL TOTAL HARMONIC DISTORTION vs DIFFERENTIAL OUTPUT VOLTAGE

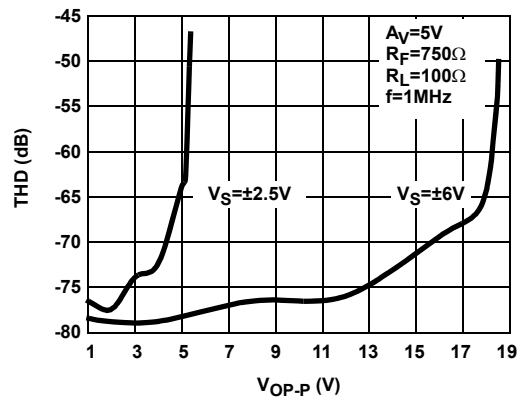

FIGURE 9. DIFFERENTIAL TOTAL HARMONIC DISTORTION vs DIFFERENTIAL OUTPUT VOLTAGE

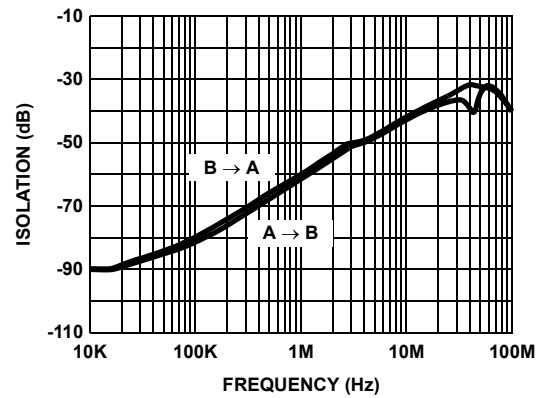

FIGURE 10. CHANNEL ISOLATION vs FREQUENCY

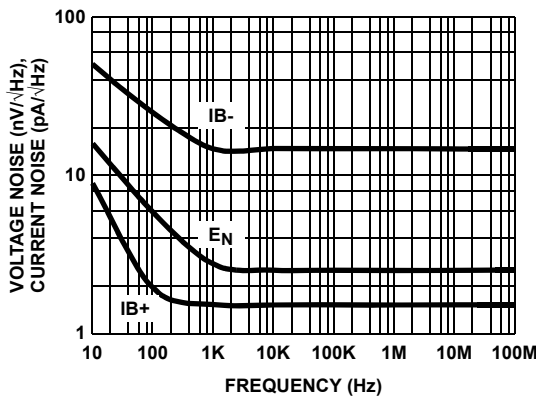

FIGURE 11. VOLTAGE AND CURRENT NOISE vs FREQUENCY

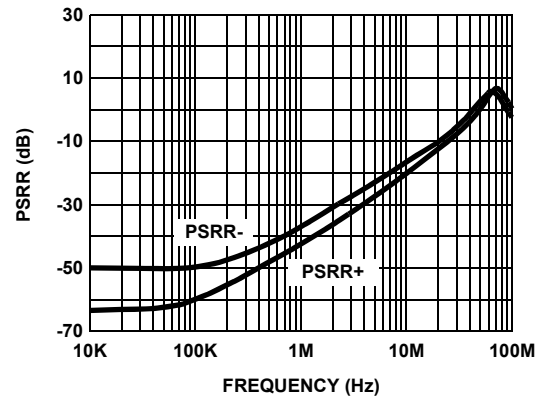

FIGURE 12. POWER SUPPLY REJECTION vs FREQUENCY

**Typical Performance Curves**

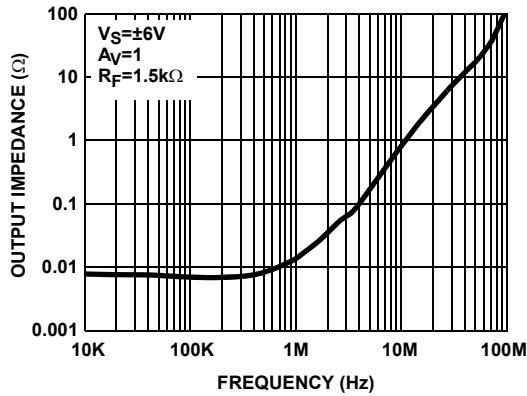

FIGURE 13. OUTPUT IMPEDANCE vs FREQUENCY

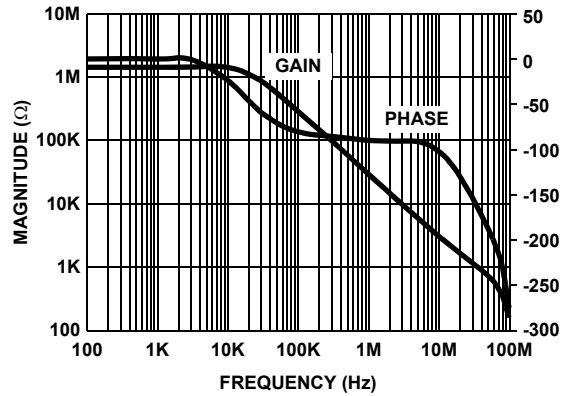

FIGURE 14. TRANSIMPEDANCE (ROL) vs FREQUENCY

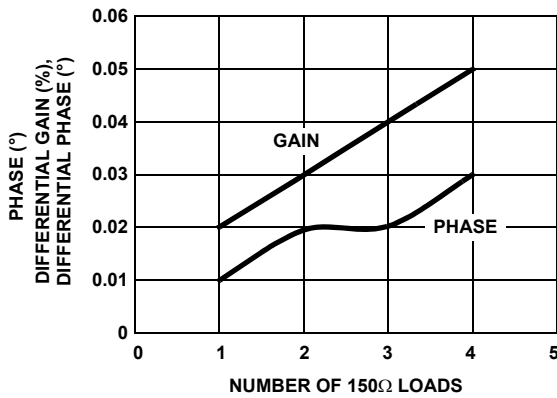

FIGURE 15. DIFFERENTIAL GAIN AND DIFFERENTIAL PHASE

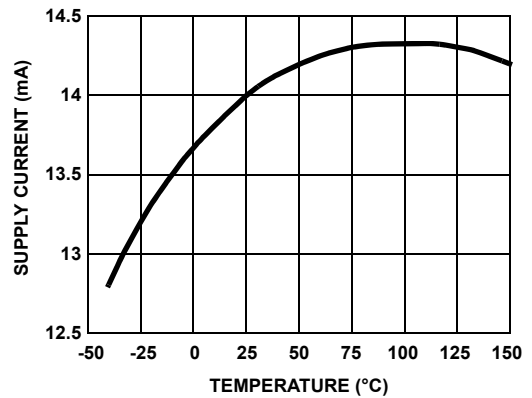

FIGURE 16. SUPPLY CURRENT vs TEMPERATURE

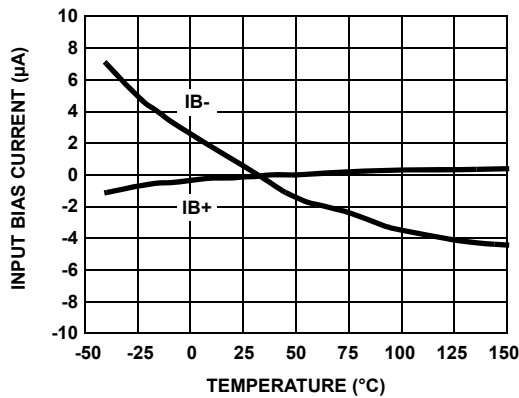

FIGURE 17. INPUT BIAS CURRENT vs TEMPERATURE

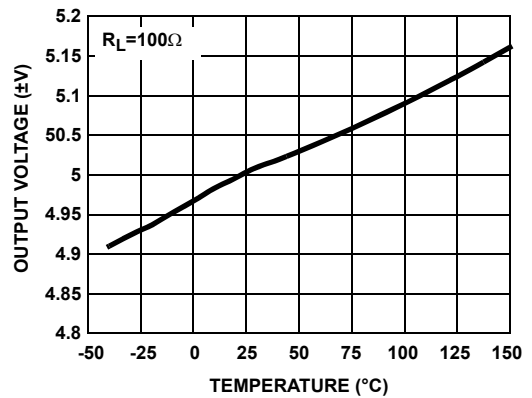

FIGURE 18. OUTPUT VOLTAGE vs TEMPERATURE

**Typical Performance Curves**

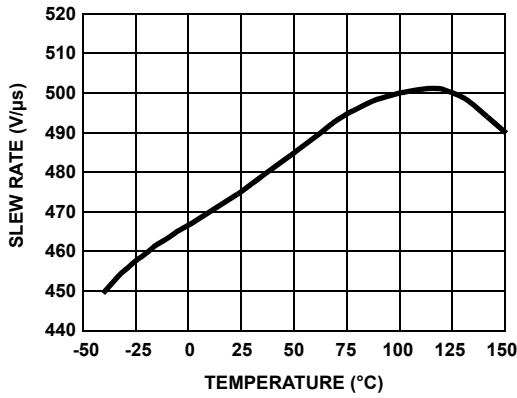

FIGURE 19. SLEW RATE vs TEMPERATURE

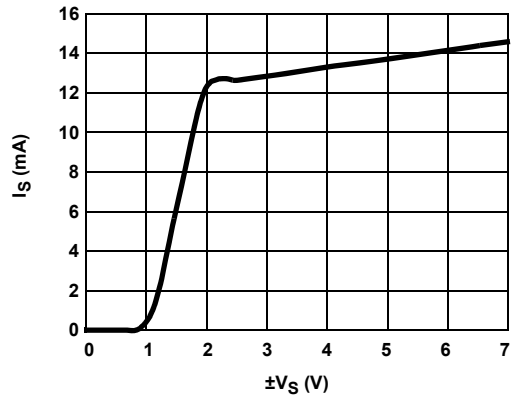

FIGURE 20. SUPPLY CURRENT vs SUPPLY VOLTAGE

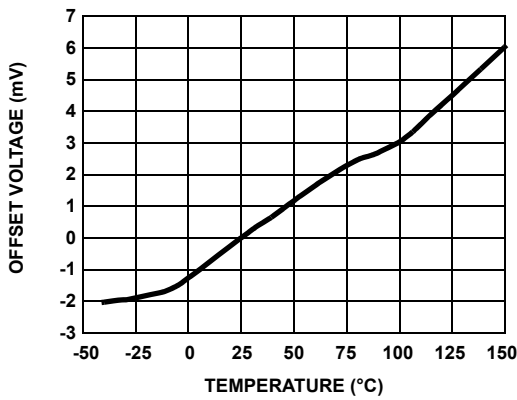

FIGURE 21. OFFSET VOLTAGE vs TEMPERATURE

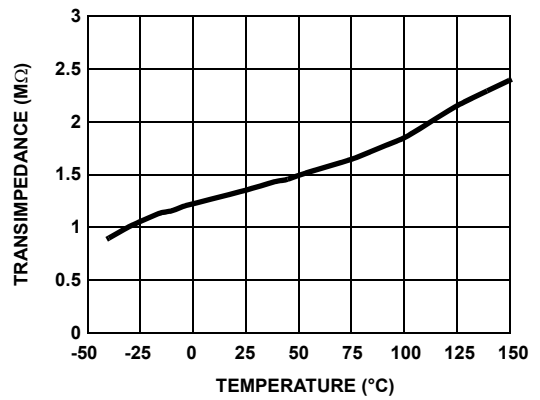

FIGURE 22. TRANSIMPEDANCE vs TEMPERATURE

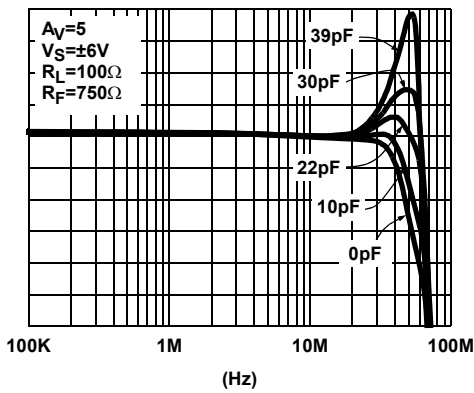

FIGURE 23. DIFFERENTIAL FREQUENCY RESPONSE vs  $C_L$

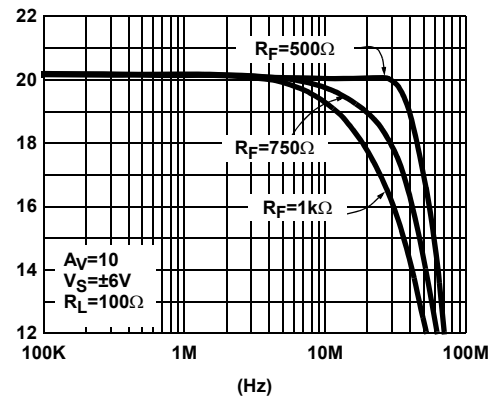

FIGURE 24. DIFFERENTIAL FREQUENCY RESPONSE vs  $R_F$

## Typical Performance Curves

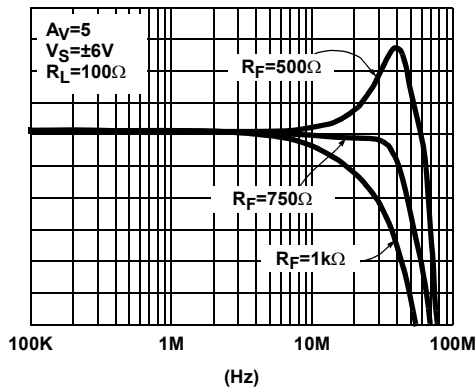

FIGURE 25. DIFFERENTIAL FREQUENCY RESPONSE vs  $R_F$

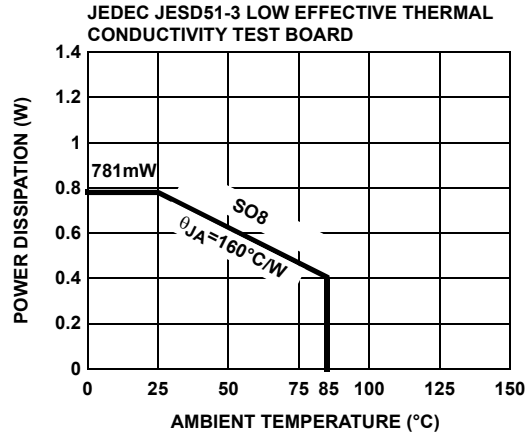

FIGURE 26. PACKAGE POWER DISSIPATION vs AMBIENT TEMPERATURE

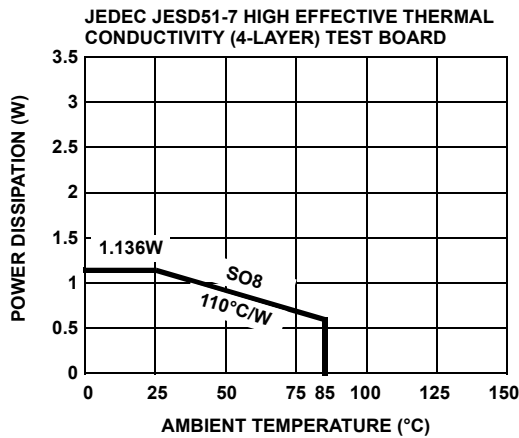

FIGURE 27. PACKAGE POWER DISSIPATION vs AMBIENT TEMPERATURE

## Applications Information

### Product Description

The EL1519 is a dual operational amplifier designed for customer premise line driving in DMT ADSL solutions. It is a dual current mode feedback amplifier with low distortion while drawing moderately low supply current. It is built using Elantec's proprietary complimentary bipolar process and is offered in industry standard pin-outs. Due to the current feedback architecture, the EL1519 closed-loop 3dB bandwidth is dependent on the value of the feedback resistor. First the desired bandwidth is selected by choosing the feedback resistor,  $R_F$ , and then the gain is set by picking the gain resistor,  $R_G$ . The curves at the beginning of the Typical Performance Curves section show the effect of varying both  $R_F$  and  $R_G$ . The 3dB bandwidth is somewhat dependent on the power supply voltage.

### Power Supply Bypassing and Printed Circuit Board Layout

As with any high frequency device, good printed circuit board layout is necessary for optimum performance. Ground plane construction is highly recommended. Lead lengths should be as short as possible, below 1/4". The power supply pins must be well bypassed to reduce the risk of oscillation. A 1.0μF tantalum capacitor in parallel with a 0.01μF ceramic capacitor is adequate for each supply pin.

For good AC performance, parasitic capacitances should be kept to a minimum, especially at the inverting input. This implies keeping the ground plane away from this pin. Carbon resistors are acceptable, while use of wire-wound resistors should not be used because of their parasitic inductance. Similarly, capacitors should be low inductance for best performance.

### Capacitance at the Inverting Input

Due to the topology of the current feedback amplifier, stray capacitance at the inverting input will affect the AC and transient performance of the EL1519 when operating in the non-inverting configuration.

In the inverting gain mode, added capacitance at the inverting input has little effect since this point is at a virtual ground and stray capacitance is therefore not “seen” by the amplifier.

### Feedback Resistor Values

The EL1519 has been designed and specified with  $R_F=750\Omega$  for  $A_V = +5$ . This value of feedback resistor yields extremely flat frequency response with little to no peaking out to 50MHz. As is the case with all current feedback amplifiers, wider bandwidth, at the expense of slight peaking, can be obtained by reducing the value of the feedback resistor. Inversely, larger values of feedback resistor will cause rolloff to occur at a lower frequency. See the curves in the Typical Performance Curves section which show 3dB bandwidth and peaking vs. frequency for various feedback resistors and various supply voltages.

### Bandwidth vs Temperature

Whereas many amplifier's supply current and consequently 3dB bandwidth drop off at high temperature, the EL1519 was designed to have little supply current variations with temperature. An immediate benefit from this is that the 3dB bandwidth does not drop off drastically with temperature.

### Supply Voltage Range

The EL1519 has been designed to operate with supply voltages from  $\pm 2.5V$  to  $\pm 6V$ . Optimum bandwidth, slew rate, and video characteristics are obtained at higher supply voltages. However, at  $\pm 2.5V$  supplies, the 3dB bandwidth at  $A_V = +2$  is a respectable 40MHz.

### Single Supply Operation

If a single supply is desired, values from +5V to +12V can be used as long as the input common mode range is not exceeded. When using a single supply, be sure to either 1) DC bias the inputs at an appropriate common mode voltage and AC couple the signal, or 2) ensure the driving signal is within the common mode range of the EL1519.

### ADSL CPE Applications

The EL1519 is designed as a line driver for ADSL CPE modems. It is capable of outputting 250mA of output current with a typical supply voltage headroom of 1.3V. It can achieve -85dBc of distortion at low 7.1mA of supply current per amplifier.

The average line power requirement for the ADSL CPE application is 13dBm (20mW) into a  $100\Omega$  line. The average line voltage is  $1.41V_{RMS}$ . The ADSL DMT peak to average ratio (crest factor) of 5.3 implies peak voltage of 7.5V into the line. Using a differential drive configuration and transformer coupling with standard back termination, a transformer ratio of 1:2 is selected. The circuit configuration is as shown below.

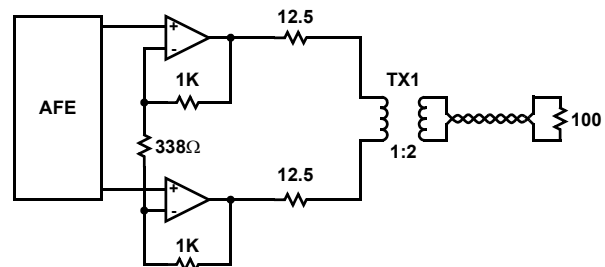

© Copyright Intersil Americas LLC 2004-2007. All Rights Reserved.

All trademarks and registered trademarks are the property of their respective owners.

For additional products, see [www.intersil.com/en/products.html](http://www.intersil.com/en/products.html)

Intersil products are manufactured, assembled and tested utilizing ISO9001 quality systems as noted in the quality certifications found at [www.intersil.com/en/support/qualandreliability.html](http://www.intersil.com/en/support/qualandreliability.html)

*Intersil products are sold by description only. Intersil may modify the circuit design and/or specifications of products at any time without notice, provided that such modification does not, in Intersil's sole judgment, affect the form, fit or function of the product. Accordingly, the reader is cautioned to verify that datasheets are current before placing orders. Information furnished by Intersil is believed to be accurate and reliable. However, no responsibility is assumed by Intersil or its subsidiaries for its use; nor for any infringements of patents or other rights of third parties which may result from its use. No license is granted by implication or otherwise under any patent or patent rights of Intersil or its subsidiaries.*

For information regarding Intersil Corporation and its products, see [www.intersil.com](http://www.intersil.com)



**Small Outline Package Family (SO)**

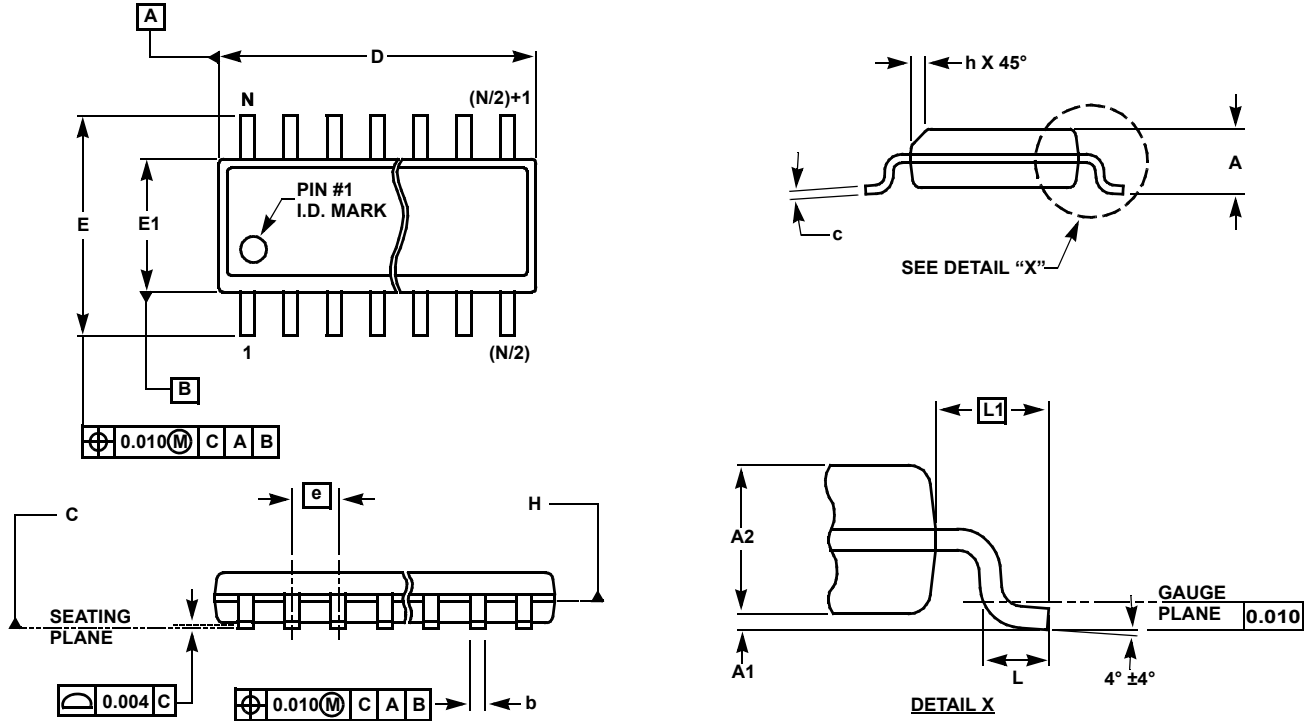

**MDP0027**

**SMALL OUTLINE PACKAGE FAMILY (SO)**

| SYMBOL | INCHES |       |               |                        |               |               |               | TOLERANCE | NOTES |
|--------|--------|-------|---------------|------------------------|---------------|---------------|---------------|-----------|-------|
|        | SO-8   | SO-14 | SO16 (0.150") | SO16 (0.300") (SOL-16) | SO20 (SOL-20) | SO24 (SOL-24) | SO28 (SOL-28) |           |       |
| A      | 0.068  | 0.068 | 0.068         | 0.104                  | 0.104         | 0.104         | 0.104         | MAX       | -     |
| A1     | 0.006  | 0.006 | 0.006         | 0.007                  | 0.007         | 0.007         | 0.007         | ±0.003    | -     |
| A2     | 0.057  | 0.057 | 0.057         | 0.092                  | 0.092         | 0.092         | 0.092         | ±0.002    | -     |
| b      | 0.017  | 0.017 | 0.017         | 0.017                  | 0.017         | 0.017         | 0.017         | ±0.003    | -     |
| c      | 0.009  | 0.009 | 0.009         | 0.011                  | 0.011         | 0.011         | 0.011         | ±0.001    | -     |
| D      | 0.193  | 0.341 | 0.390         | 0.406                  | 0.504         | 0.606         | 0.704         | ±0.004    | 1, 3  |
| E      | 0.236  | 0.236 | 0.236         | 0.406                  | 0.406         | 0.406         | 0.406         | ±0.008    | -     |
| E1     | 0.154  | 0.154 | 0.154         | 0.295                  | 0.295         | 0.295         | 0.295         | ±0.004    | 2, 3  |
| e      | 0.050  | 0.050 | 0.050         | 0.050                  | 0.050         | 0.050         | 0.050         | Basic     | -     |
| L      | 0.025  | 0.025 | 0.025         | 0.030                  | 0.030         | 0.030         | 0.030         | ±0.009    | -     |
| L1     | 0.041  | 0.041 | 0.041         | 0.056                  | 0.056         | 0.056         | 0.056         | Basic     | -     |
| h      | 0.013  | 0.013 | 0.013         | 0.020                  | 0.020         | 0.020         | 0.020         | Reference | -     |
| N      | 8      | 14    | 16            | 16                     | 20            | 24            | 28            | Reference | -     |

Rev. M 2/07

**NOTES:**

1. Plastic or metal protrusions of 0.006" maximum per side are not included.
2. Plastic interlead protrusions of 0.010" maximum per side are not included.
3. Dimensions "D" and "E1" are measured at Datum Plane "H".
4. Dimensioning and tolerancing per ASME Y14.5M-1994