

## SUMMARY



Image is for illustrative purpose only

### # Wires

Low	0
High	0
Coax	1
Triax	0
Quad	0
Fiber	0
Fluidic	0

### Download

[Request a quote](#)

[Catalog](#)

Series	1S
Termination type	Female solder
IP rating	50
Cable Ø	0.00 - 0.00 mm
Matching parts	FFA.1S.275.CTAC17
Status	active
Alternative part	

## TECHNICAL DETAILS

### Mechanics

Shell Style/Model	EEP*: Fixed receptacle, nut fixing (back panel mounting)
Keying	
Housing Material	Brass (chrome plated) shell and collet nut, nickel plated brass latch sleeve and mid pieces
Cable Fixing	∅0 - 0 mm
Variant	
Weight	9.86 g

### Performance

Configuration	1S.275 : 1 Coax (75 Ohm)
Insulator	T: PTFE
Rated Current	10 Amps

### Specifications

Contact Type:	Coaxial 75 Ohm (Solder)
Max. Matings:	1000
Contact Dia.:	1.3 mm (0.0512in)

LEMO products and services are provided "as is". LEMO makes no warranties or representations with regard to LEMO product & services or use of them, express, implied or statutory, including for accuracy, completeness, or security. The user is fully responsible for his products and applications using LEMO components.

Bucket Dia.: 1.1 mm (0.0432in)

Vtest: 2400 V (AC), 3300 V (DC)

Impedance: 75 Ohm

VSWR:  $1.02 + 0.08 * f/\text{GHz}$

Cable type: RG 179 B/U, RG 187 A/U, RG 58 C/U, RG 302 /U, RG 400 /U, 2YCCY, RG 59 B/U, RG 223 /U, HF-5408

## Others

Endurance (Shell): 5000 mating cycles

Temp (min / max):  $-55^{\circ}\text{C} / +250^{\circ}\text{C}$

Humidity (max):  $\leq 95\%$  [at 60 deg C / 140 F]

Vibration: 15 g [10 Hz - 2000 Hz]

Shock Resistance: 100 g [ 6 ms]

Salt Spray Corrosion: >1000 hr

Climatical Category: 50/175/21

Shielding (min): 75 dB (10 MHz)

Shielding (min): 40 dB (1 GHz)

IP Rating: 50

---

## DRAWINGS

### Draws

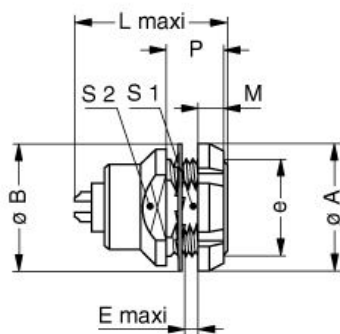

### Dimensions

	A	B	E	L	M	P	S1	S2	e
mm.	16	16	6.5	20.5	3.5	11	10.5	13	M12x1.0
in.	0,63	0,63	0,26	0,81	0,14	0,43	0,41	0,51	

---







LEMO products and services are provided "as is". LEMO makes no warranties or representations with regard to LEMO product & services or use of them, express, implied or statutory, including for accuracy, completeness, or security. The user is fully responsible for his products and applications using LEMO components.

# RECOMMENDED BY LEMO



## Tools

None

## Cables

CCN.50.051.1529NMC			
017 420	PVC	Black	
017 450	COPOLYMER	Black	
018 000	PTFE	Brown	
018 700	PTFE	White	
018 800	PTFE	White	
031 600	PTFE	Brown	
062 000	PVC	Black	
158 480	PUR	Black	
158 490	PVC	Black	
159 580	PVC	Black	
178 190	PTFE	Brown	
196 270	PTFE	White	
CCX.50.030.083.180B		White	
CCX.50.080.297538N	PVC	Black	
CCX.50.088.292495N	PVC	Black	
CCX.50.RG0.58AU14B	FEP	White	
CCX.50.RG0.58AU61J	PVC	Yellow	
CCX.50.RG1.74-U25N	PVC	Black	
CCX.50.RG1.74AU28N	PVC	Black	
CCX.50.RG1.74AU28N	PVC	Black	
CCX.50.RG1.74U25N	PVC	Black	
CCX.50.RG1.78BU18M	FEP	Brown	
CCX.50.RG1.78BU18M	PTFE	Brown	
CCX.50.RG1.88AU24B	TFE	White	
CCX.50.RG1.88AU26B	PFA	White	
CCX.50.RG1.88AU26B	PTFE	White	
CCX.50.RG1.96AU19B	PTFE	White	
CCX.50.RG1.96AU20B	PFA	White	
CCX.50.RG3.16BU26M	FEP	Brown	
CCX.50.RG3.16U28M	PTFE	Brown	
CCX.50.RG5.8CU50N	PVC	Black	
CCX.75.040.195327G	PVC	Grey	
CCX.75.RG0.59BU62N	PVC	Black	

LEMO products and services are provided "as is". LEMO makes no warranties or representations with regard to LEMO product & services or use of them, express, implied or statutory, including for accuracy, completeness, or security. The user is fully responsible for his products and applications using LEMO components.

CCX.75.RG1.79BU26M	FEP	Brown	
CCX.75.RG1.87AU26B	PFA	White	
CCX.75.RG1.87AU27B	PTFE	White	
CCX.93.RG0.62AU62N	PVC	Black	
CCX.95.RG1.80BU36M	PTFE	Brown	
CCX.95.RG1.95AU37B	PFA	White	

*LEMO products and services are provided "as is". LEMO makes no warranties or representations with regard to LEMO product & services or use of them, express, implied or statutory, including for accuracy, completeness, or security. The user is fully responsible for his products and applications using LEMO components.*