

Rotary DIP Switches, Unsealed, Through Hole, Straight and Right-Angle

FEATURES:

- High pressure contacts (140K PSI) provide 20,000 Steps.
- Unique design utilizes high pressure pin-point sliding contacts to penetrate contaminants on contact surface.
- Terminals insert molded into base.

- Screwdriver, knob and shaft (plastic and steel) type actuators available in both upright and right angle versions.

- 10 And 16 position versions with both real and complement codes.

Note: Common terminals connected internally.

MATERIAL SPECIFICATIONS:

ContactsGold flashed copper alloy

TerminalsTin Lead Plated

Base, Rotor, CasePolyester

ENVIRONMENTAL SPECIFICATIONS:

Operating Temperature.....-22°F to +185°F (-30°C to +85°C)

Storage Temperature.....-49°F to +212°F (-45°C to +100°C)

Vibration Resistance.....Subjected to vibration of 10-55hz per second with a total amplitude of .06 in. in 3 mutually perpendicular directions for 2 hours each

Shock ResistanceWill withstand 50G acceleration in 3 different planes for a period of 11 milliseconds

Salt Spray TestWithstands an atmosphere of 5% salt water at temperature of 50°C

Hydrogen Sulfide TestWithstands an atmosphere of 15-20 PPM hydrogen sulfide gas at temperature of 40°C for 240 hours

Atmosphere Test.....Withstands an atmosphere of 30-50 PPM sulfide gas at a temperature of 40°C for 240 hours

Solder Heat ResistanceWithstands 5 sec. flow solder bath of 260°C when mounted on a .06" thick PC board per MIL-STD 202, Method 210

TYPICAL PERFORMANCE CHARACTERISTICS:

Contact Rating0.4 VA @ 20 VDC

Initial Contact Resistance50 Milliohms max. @ 2 VDC

Insulation Resistance1,000 Megohms min. @ 100 VDC

Dielectric Strength300 VAC RMS @ sea level

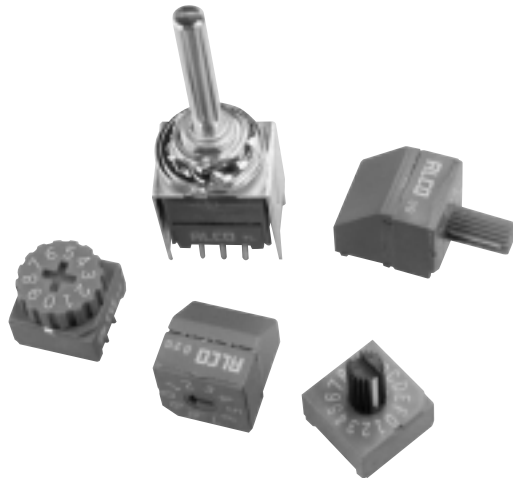

Example: DRW 10RA = Rotary Dip with Wheel actuator BDC -10 position Right angle PC terminations

Series
Rotary Dips (blue case)

Actuator Style

- *D = Flush
- M = Mini plastic shaft
- W = Wheel
- S = Metal shaft

Circuit Type

- 10 = BCD
- 10C = BCD complement
- 16 = Hexadecimal
- 16C = Hexadecimal complement

HOW TO ORDER

Terminations

- Blank = PC
- RA = Right angle for DRM, DRW, DRS only
- RAE = Right angle, Auto Assembly Compatible for DRD type only

*DRD Available in RAE version only. For PC or SMT versions, see Pg. A24 DRD "E" Process Sealed Product.

Rotary DIP Switches, Unsealed, Through Hole, Straight and Right-Angle

FOOTPRINTS

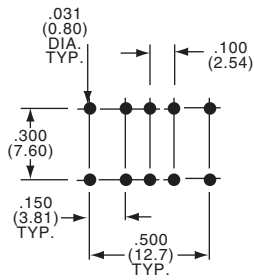

**S STYLE VERTICAL
(METAL SHAFT)**

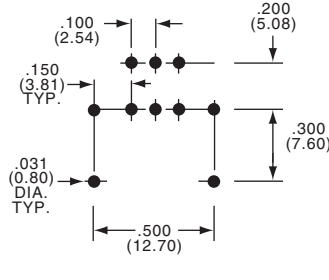

**S STYLE RA
(METAL SHAFT)**

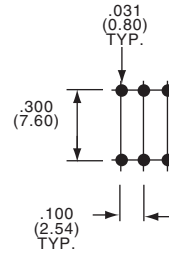

PC

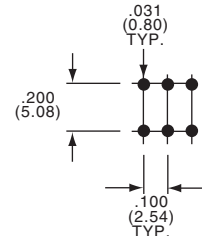

**PC
RIGHT ANGLE**

TRUTH TABLES

Terminal Identification
(view from bottom of the switch)

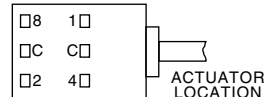
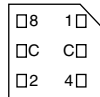

10-Position, BCD (red actuator)										
Pos.	0	1	2	3	4	5	6	7	8	9
C	X	X	X	X	X	X	X	X	X	X
1		X		X		X		X		X
2			X	X			X	X		
4					X	X	X	X		
8									X	X

16-Position, Hexadecimal (black actuator)																
Pos.	0	1	2	3	4	5	6	7	8	9	A	B	C	D	E	F
C	X	X	X	X	X	X	X	X	X	X	X	X	X	X	X	X
1		X		X		X		X		X		X		X		X
2			X	X			X	X			X	X			X	X
4					X	X	X	X					X	X	X	X
8									X	X	X	X	X	X	X	X

10-Position, BCD Complement (orange actuator)										
Pos.	0	1	2	3	4	5	6	7	8	9
\bar{C}	X	X	X	X	X	X	X	X	X	X
$\bar{1}$	X		X		X		X		X	
$\bar{2}$	X	X			X	X			X	X
$\bar{4}$	X	X	X	X					X	X
$\bar{8}$	X	X	X	X	X	X	X	X		

16-Position Hexadecimal Complement (white actuator)																
Pos.	0	1	2	3	4	5	6	7	8	9	A	B	C	D	E	F
\bar{C}	X	X	X	X	X	X	X	X	X	X	X	X	X	X	X	X
$\bar{1}$	X		X		X		X		X		X		X		X	
$\bar{2}$	X	X			X	X			X	X			X	X		
$\bar{4}$	X	X	X	X					X	X	X	X				
$\bar{8}$	X	X	X	X	X	X	X	X								

Rotary DIP Switches, Unsealed, Through Hole, Metal Shaft or Wheel Actuator

“S” METAL SHAFT ACTUATOR

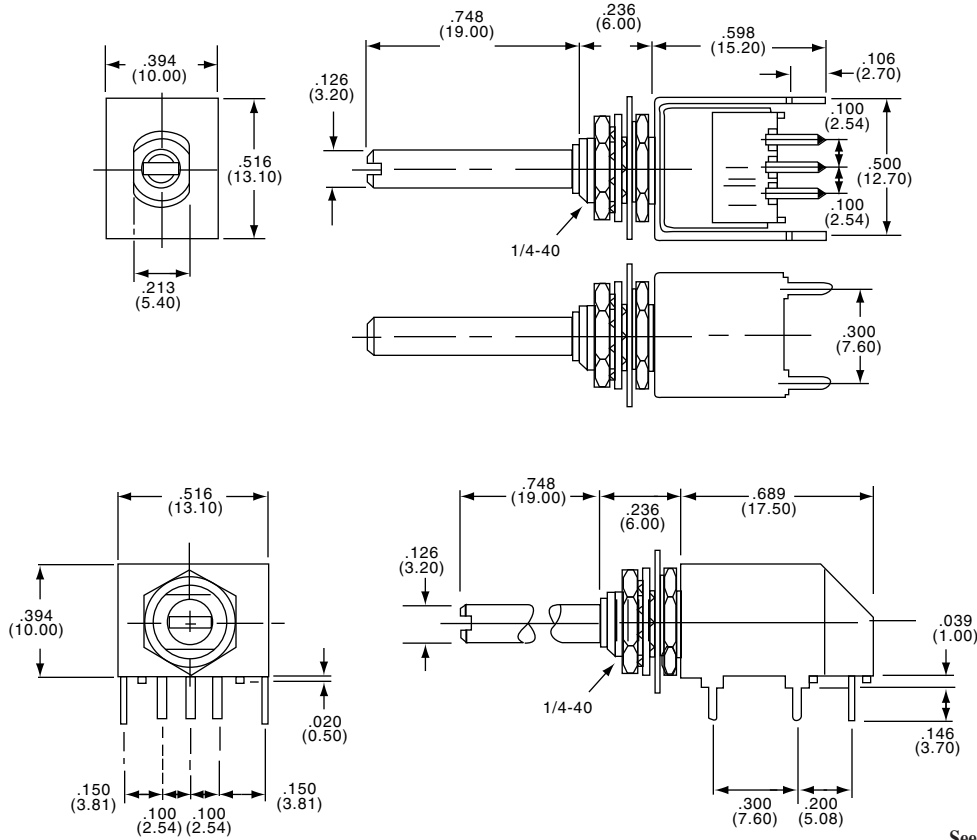

See Section K for knob selection

“W” WHEEL ACTUATOR

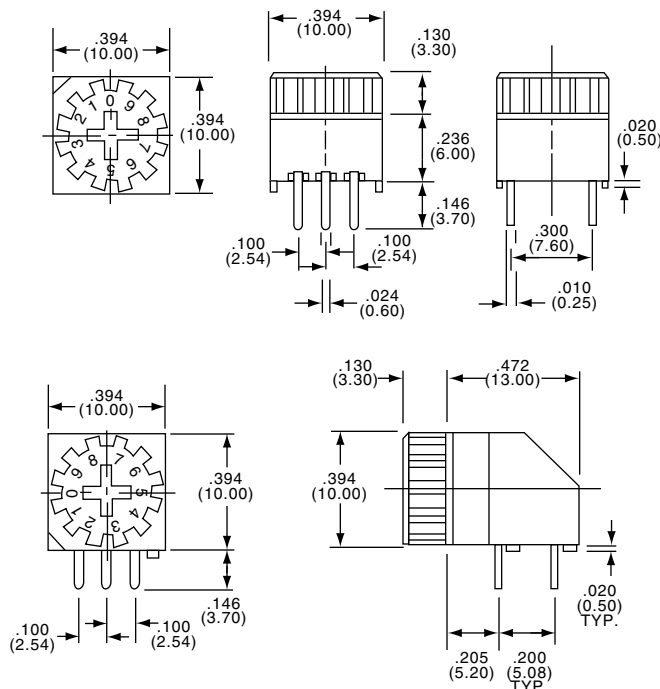

Rotary DIP Switches, Unsealed, Through-Hole, Flush and Mini Shaft Actuator

“D” FLUSH ACTUATOR

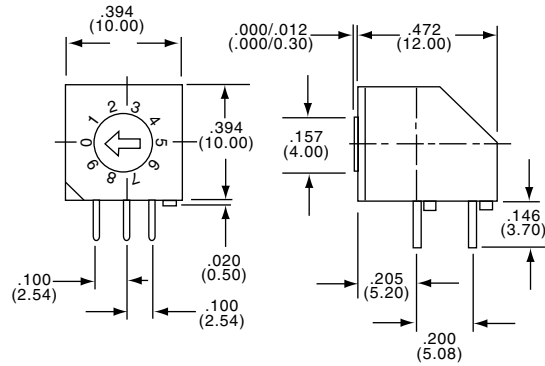

DIM.	DR	RC, *RA, RR
A	.236 (6.00)	.256 (6.50)
B	.146 (3.70)	.126 (3.20)

“M” MINI-SHAFT ACTUATOR

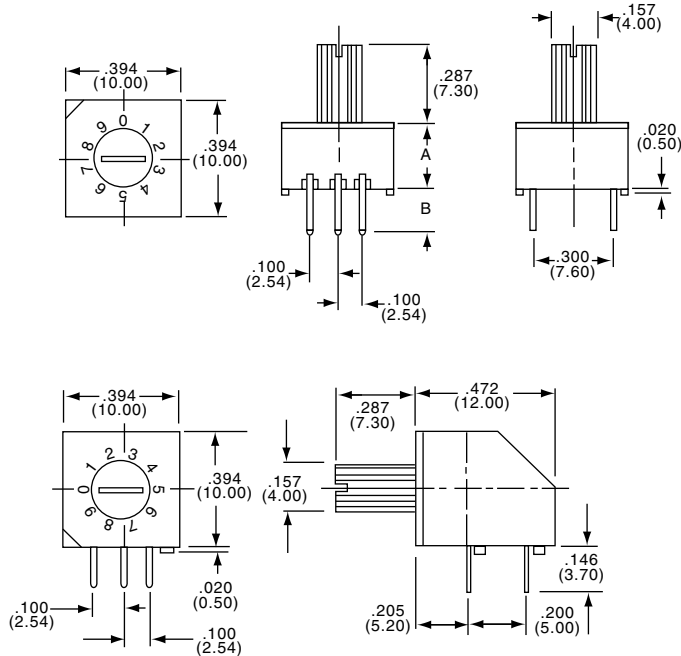

DIM.	DR	RR
A	.236 (6.00)	.256 (6.50)
B	.146 (3.70)	.126 (3.20)