

TEST DATA

ITEM	SPEC	SAMPLE									
		1	2	3	4	5	6	7	8	9	10
Primary Exciting Current Input 120VAC , 60 Hz	90 mA max	44	47	50							
Primary Load Current Input 120VAC , 60 Hz	190 mA max	140	143	142							
Secondary No Load DC Voltage	13V ±5%	13.26	13.27	13.2							
Secondary DC Voltage Load 1000 mA	9V ±5%	9.1	9.12	9.17							
Secondary Voltage Load mA	V ± %										
Secondary Voltage Load mA	V ± %										
Secondary Voltage Load mA	V ± %										
Secondary Voltage Load mA	V ± %										
Ripple Voltage Load 1000 mA (PK-PK)	2.5V max	1.7	1.7	1.7							
Hi-Pot Test 3 mA for 3Sec.	Pri. to Sec.	2K VAC	OK	OK	OK						
	Pri. to Core	2K VAC	OK	OK	OK						
	Sec. to Core	1.5K VAC	OK	OK	OK						
Temperature Rise: 70°C MAX measured By Resistance Method (Primary Winding)											
Core Film: SPLIT						Core : EI-41					
Testing Circuit:		2200uF/16V				Output Plug Drawing: PLUG: 5.5*2.5mm					
											
Output conductor length: 6FT min (AWG#22)											
Input conductor length: ft min (AWG#)											
(V) Characteristic Curve											
											

AC Adaptor Specifications

Internal Construction Drawing and Parts List (Unit: Set or EA)

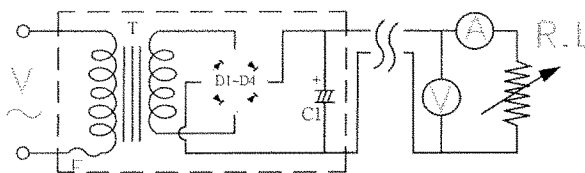
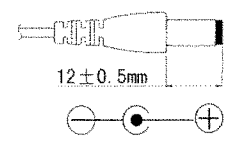
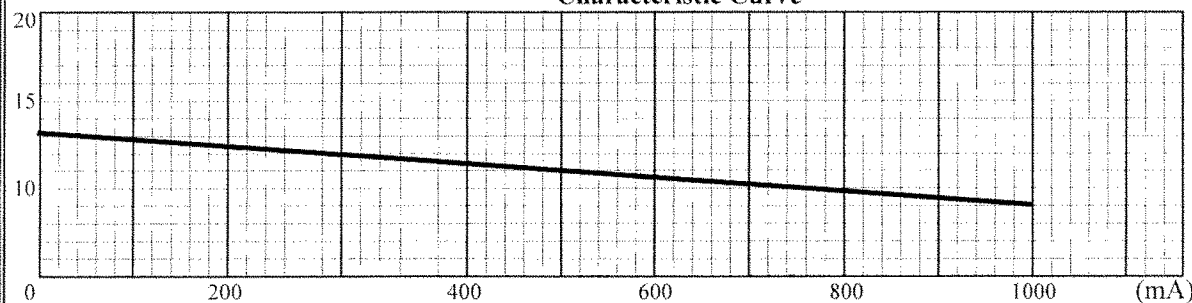
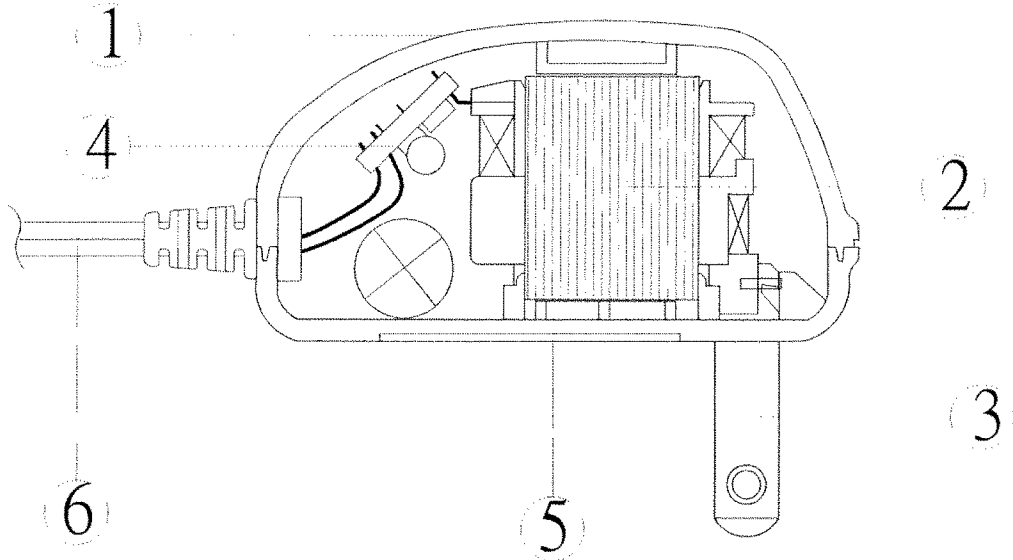

Part Name	Specification	Q'ty
1. Enclosure	Noryl SE1 94V-1 105°C	
	Noryl SE-100 94V-1 95°C	
	Noryl PX1700 94V-1 95°C	
	940(f1) 94V-0 130°C	
2. Transformer	EI-4I	1
3. Blade	Ni plated brass	2
4. Print Wiring Board Assembly		
Print Wiring Board	04V0 94V-0 130°C	1
	11 94V-0 105°C	
	13 94V-0 130°C	
	BF-3 94V-0 130°C	
Diode	1A 50V 1N5819	4
Capacitor	2200uf 16V 85°C	1
5. Name Plate	Polyester Film	1
6. Output Cord	AWG# 22 6FT min	1

AC Adaptor Specifications

Construction Drawing and Details of Transformer

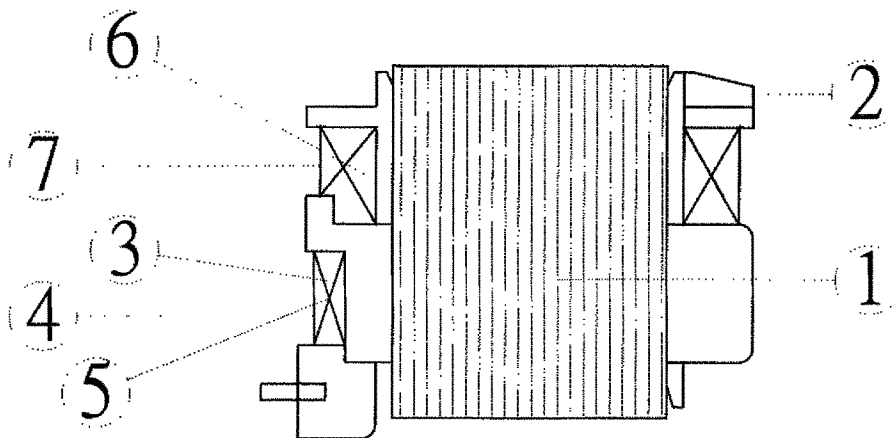

Part Name	Material & Type	Spec or Q'ty
1. Core	Silicon Steel	0.35mm
2. Bobbin	Polybutylene Terephthalate	0.71mm
	1403G6	
	PETP(QMFZ2)	
	FR-530, FR530L	
	Nylon 101L	
3. Primary Winding	Polyurethane Enameled Copper wire	mm turn ohm
4. Primary Outer Winding	Mylar Tape	0.025mmx2T
5. Thermal Fuse	M30 2A 125°C 250V AC	1PC
6. Secondary Winding	Polyurethane Enameled Copper Wire	mm turn ohm
7. Secondary Outer Winding	Mylar Tape	0.025mmx2T

AC Adaptor Specifications

Circuit Diagram

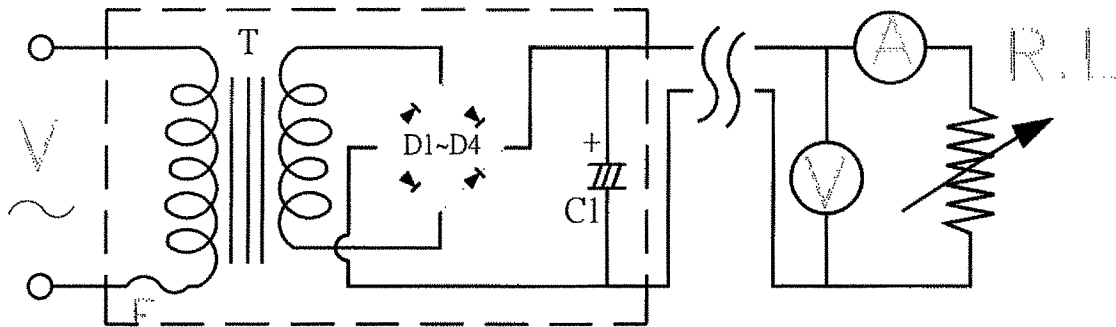

Symbol	Part Name	Note
T	Transformer	EI-41
D(1~4)	Diode	1A 50V 1N5819
C1	Capacitor	2200uF 16V 85°C
F	Thermal	125°C 2A 250V



AC Adaptor Specifications

Dimension of Nameplate (Unit:mm)

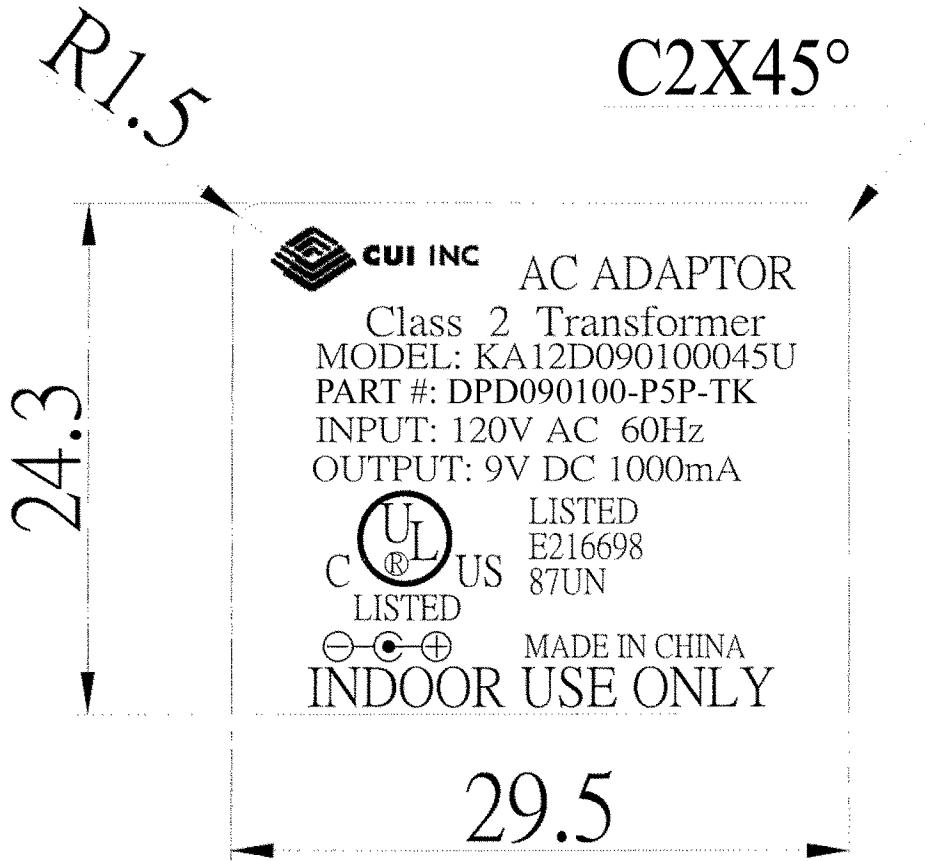

Material: Polyester Film

T: 0.25mm