

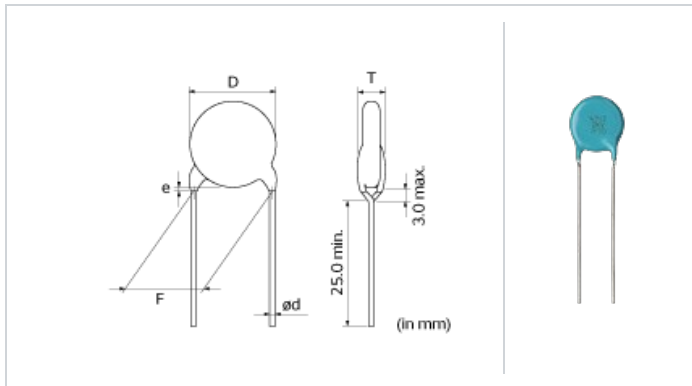

Last Time Buy Date: 30 Sep 2019 Date of discontinuation: 31 Mar 2020

< List of part numbers with package codes >
DEA1X3D470JA2B

Shape



L size or outer diameter D (mm)	6.0 mm max.
T size	5.0 mm max.
Lead spacing F	5.0 ±1.0mm
Lead diameter d	0.6 ±0.05mm
Paint dripping e	Up to the end of crimp

References

Packaging	Specifications	Minimum quantity
B	Packing in bulk	500

Specifications

Capacitance	47pF ±5%
Rated voltage	2000Vdc
Temperature characteristics (complied standard)	SL(JIS)
Temperature coefficient	+350 to -1000ppm/°C
Temperature range of temperature characteristics	20 to 85°C
Operating temperature range	-25 to 125°C

Attention

- 1.This datasheet is downloaded from the website of Murata Manufacturing Co., Ltd. Therefore, it's specifications are subject to change or our products in it may be discontinued without advance notice. Please check with our sales representatives or product engineers before ordering.
- 2.This datasheet has only typical specifications because there is no space for detailed specifications. Therefore, please review our product specifications or consult the approval sheet for product specifications before ordering.

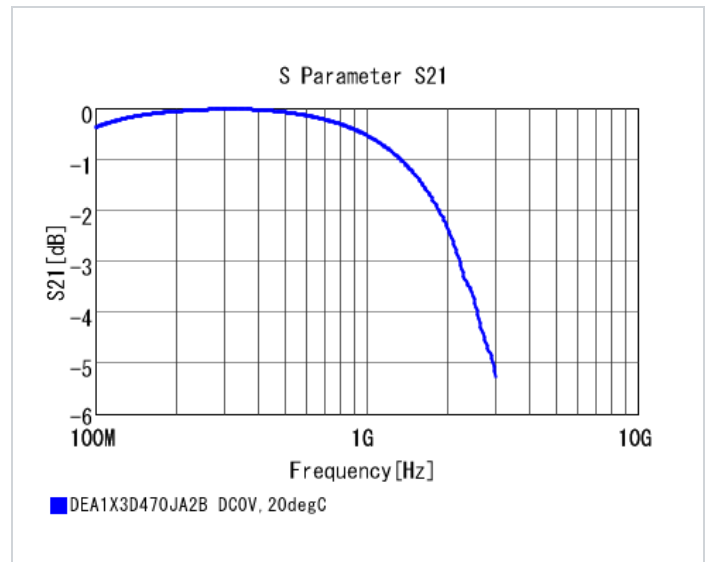
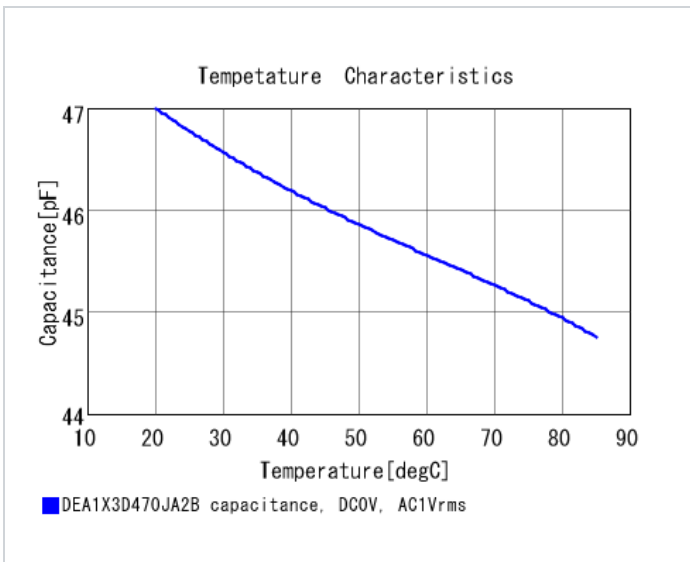
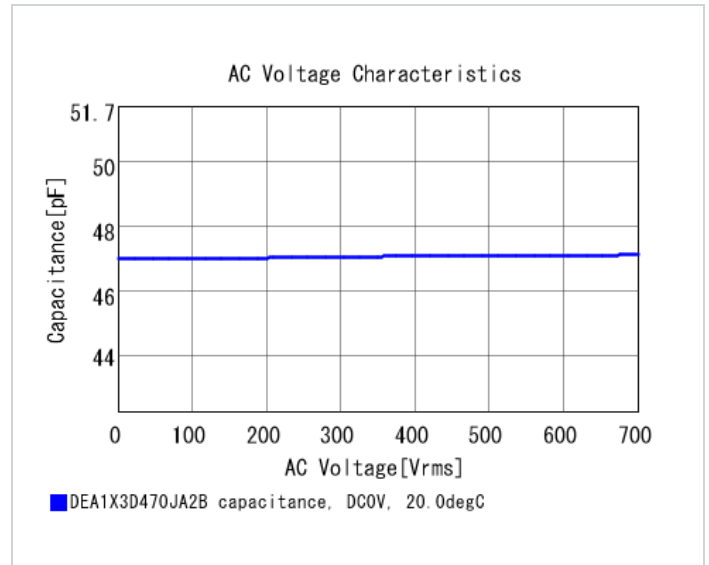
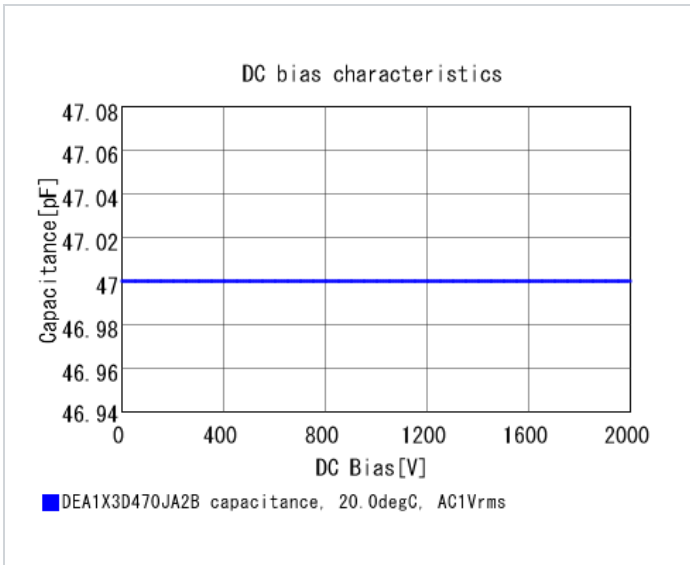
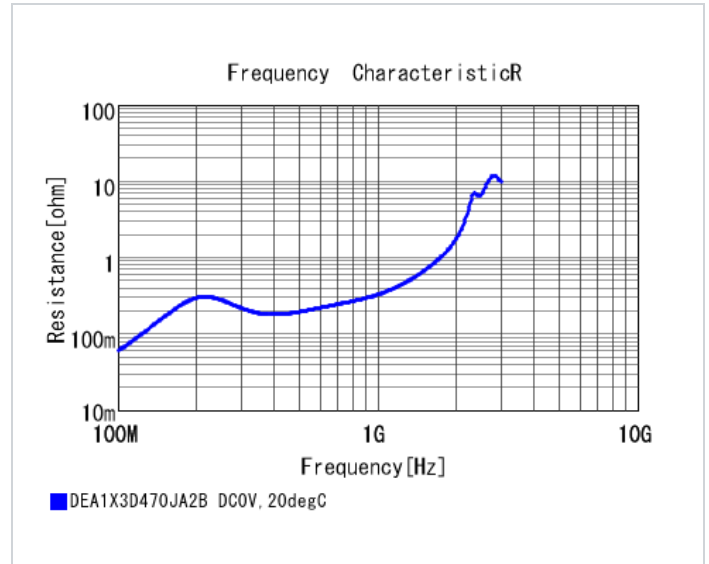
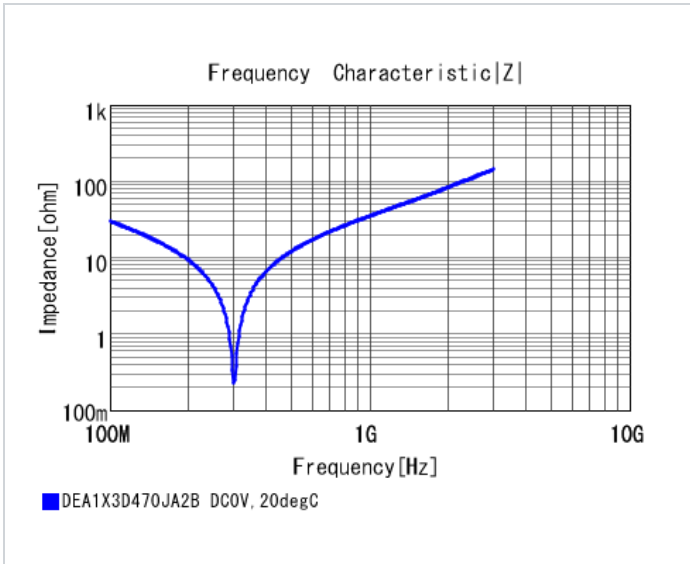

⚠ Attention

- 1.This datasheet is downloaded from the website of Murata Manufacturing Co., Ltd. Therefore, it's specifications are subject to change or our products in it may be discontinued without advance notice. Please check with our sales representatives or product engineers before ordering.
- 2.This datasheet has only typical specifications because there is no space for detailed specifications. Therefore, please review our product specifications or consult the approval sheet for product specifications before ordering.