

CZRUR52C2 Thru CZRUR52C39

Voltage 2 to 39 Volts
Power 150 mWatts
RoHS Device

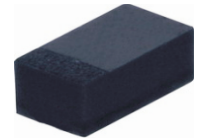

Features

- 150mW Power Dissipation.
- High Voltages from 2 ~ 39 V.
- Designed for mounting on small surface.
- Extremely thin/leadless package.
- Pb free product.

Mechanical data

- Case: 0603/SOD-523F Standard package
Molded plastic.
- Terminals: Gold plated, solderable per
MIL-STD-750,method 2026.
- Polarity: Indicated by cathode band.
- Weight: 0.003 gram(approx.).

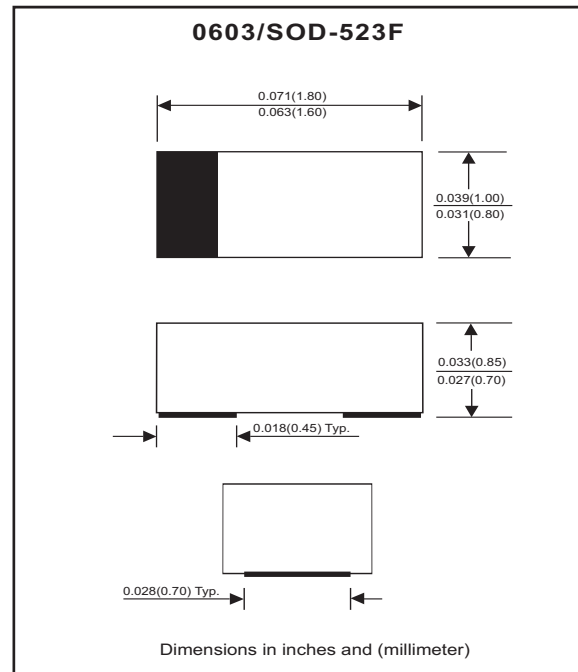

Maximum Rating AND Electrical Characteristics

Parameter	Symbol	Value	Unit
Maximum Forward Voltage Drop at $I_F = 10 \text{ mA}$	V_F	0.9	V
Maximum Power Dissipation at 25 C°	P_D	150	mW
Forward current , surge peak 8.3 ms single half sine-wave superimposed on rate load(JEDEC method)	I_{FSM}	2.0	A
Peak ESD voltage capability (IEC 61000-4-2)	V_{PV}	8	kV
Operating Junction and Storage Temperature Range	T_J	-55 to +125	$^\circ\text{C}$

Electrical Characteristics (TA=25 °C)

Part Number	Marking Code	Zener Voltage			Operating resistance		Rising operating Resistance		Reverse current	
		V _Z (V)			ZZT(Ohm)		ZZK(Ohm)		IR(μA)	
		Min	Max	I _Z (mA)	Max	I _Z (mA)	Max	I _Z (mA)	Max	V _R (V)
CZRUR52C2	Z0	1.90	2.10	5	100	5	600	1	100	1
CZRUR52C2V2	Z1	2.09	2.31	5	100	5	600	1	100	1
CZRUR52C2V4	Z2	2.28	2.52	5	85	5	600	1	100	1
CZRUR52C2V7	Z3	2.57	2.84	5	83	5	500	1	75	1
CZRUR52C3	Z4	2.85	3.15	5	95	5	500	1	50	1
CZRUR52C3V3	Z5	3.14	3.47	5	95	5	500	1	25	1
CZRUR52C3V6	Z6	3.42	3.78	5	95	5	500	1	15	1
CZRUR52C3V9	Z7	3.71	4.10	5	95	5	500	1	10	1
CZRUR52C4V3	Z8	4.09	4.52	5	95	5	500	1	5	1
CZRUR52C4V7	Z9	4.47	4.94	5	78	5	500	1	5	2
CZRUR52C5V1	ZA	4.85	5.36	5	60	5	480	1	0.1	0.8
CZRUR52C5V6	ZB	5.32	5.88	5	40	5	400	1	0.1	1
CZRUR52C6V2	ZC	5.89	6.51	5	10	5	200	1	0.1	2
CZRUR52C6V8	ZE	6.46	7.14	5	8	5	150	1	0.1	3
CZRUR52C7V5	ZF	7.13	7.88	5	7	5	50	1	0.1	5
CZRUR52C8V2	ZG	7.79	8.61	5	7	5	50	1	0.1	6
CZRUR52C9V1	ZH	8.65	9.56	5	10	5	50	1	0.1	7
CZRUR52C10	ZJ	9.50	10.50	5	15	5	70	1	0.1	7.5
CZRUR52C11	ZK	10.45	11.55	5	20	5	70	1	0.1	8.5
CZRUR52C12	ZM	11.40	12.60	5	20	5	90	1	0.1	9
CZRUR52C13	ZN	12.35	13.65	5	25	5	110	1	0.1	10
CZRUR52C15	ZP	14.25	15.75	5	30	5	110	1	0.1	11
CZRUR52C16	ZQ	15.20	16.80	5	40	5	170	1	0.1	12
CZRUR52C18	ZR	17.10	18.90	5	50	5	170	1	0.1	14
CZRUR52C20	ZS	19.00	21.00	5	50	5	220	1	0.1	15
CZRUR52C22	ZT	20.90	23.10	5	55	5	220	1	0.1	17
CZRUR52C24	ZU	22.80	25.20	5	80	5	220	1	0.1	18
CZRUR52C27	ZV	25.65	28.35	5	80	5	250	1	0.1	20
CZRUR52C30	ZW	28.50	31.50	5	80	5	250	1	0.1	23
CZRUR52C33	ZX	31.35	34.65	5	80	5	250	1	0.1	25
CZRUR52C36	ZY	34.20	37.80	5	90	5	250	1	0.1	27
CZRUR52C39	ZZ	37.05	40.95	5	90	5	300	1	0.1	29

RATING AND CHARACTERISTIC CURVES (CZRUR52C2 Thru CZRUR52C39)

Fig.1 TEMPERATURE COEFFICIENTS

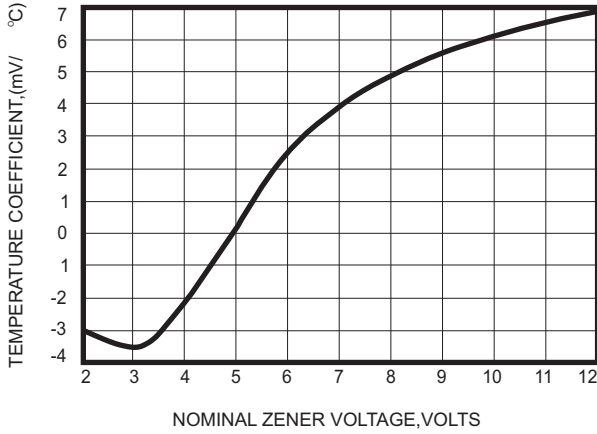

Fig.2 TEMPERATURE COEFFICIENTS



Fig.3 EFFECT OF ZENER VOLTAGE ON ZENER IMPEDANCE

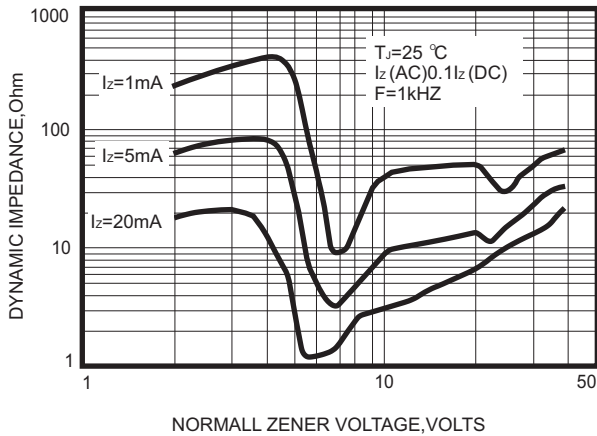

Fig.4 TYPICAL FORWARD VOLTAGE



Fig.5 TYPICAL LEAKAGE CURRENT

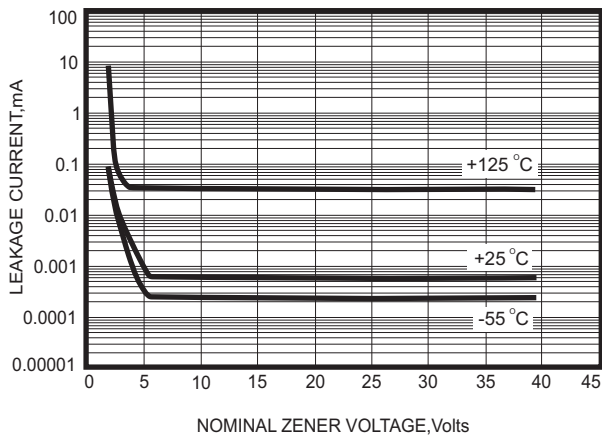
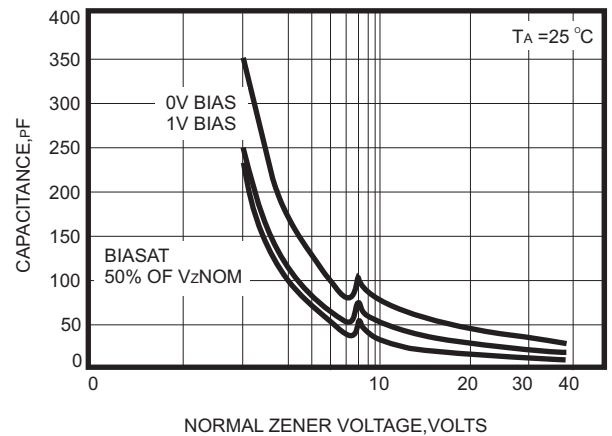

Fig.6 TYPICAL CAPACITANCE



RATING AND CHARACTERISTIC CURVES (CZRUR52C2 Thru CZRUR52C39)

Fig.7 ZENER VOLTAGE VERSUS ZENER CURRENT

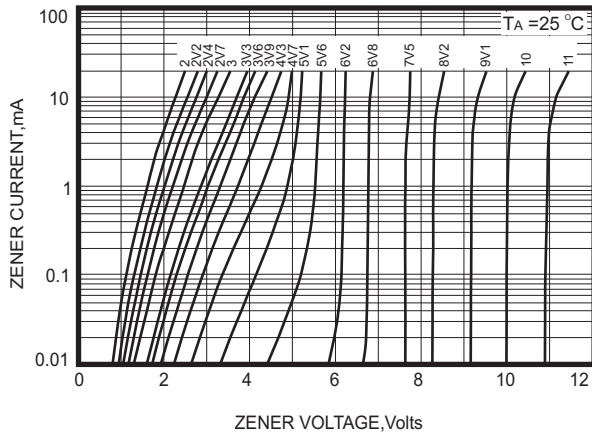

Fig.8 ZENER VOLTAGE VERSUS ZENER CURRENT

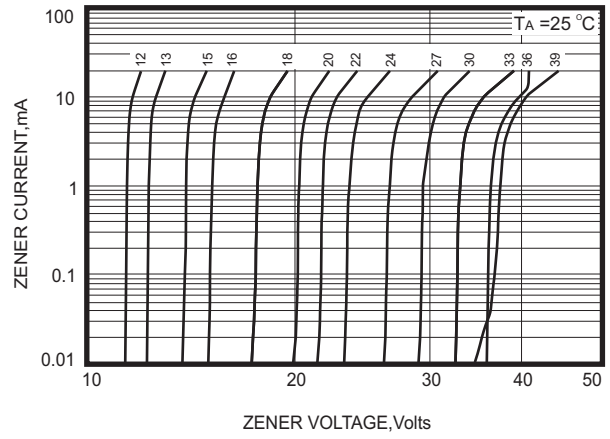
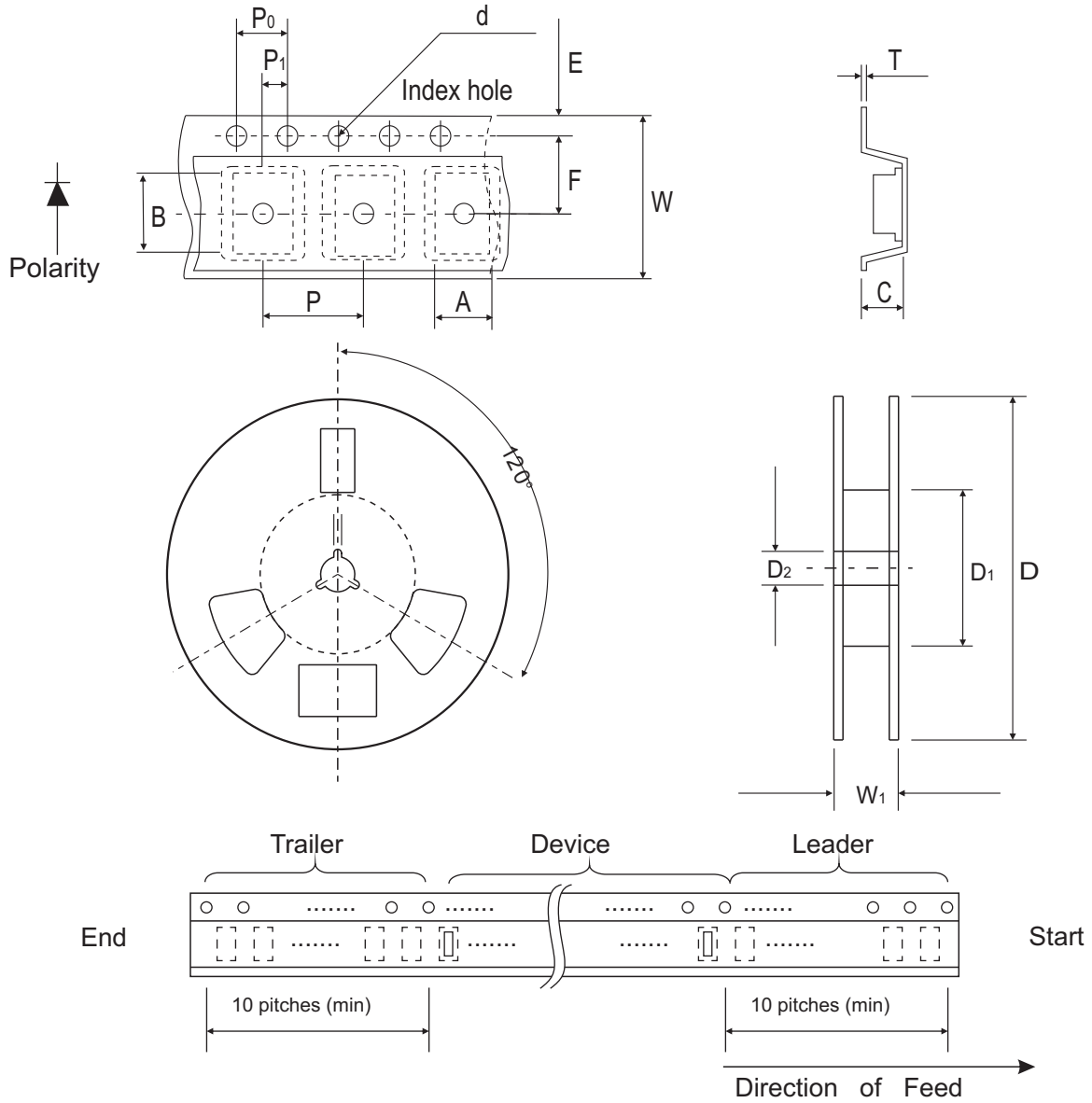

Fig.9 STEADY STATE POWER DERATING



Reel Taping Specification



0603 (SOD-523F)	SYMBOL	A	B	C	d	D	D ₁	D ₂
	(mm)	1.00 ± 0.10	1.85 ± 0.10	1.00 ± 0.10	1.55 ± 0.05	178 ± 1	60.0 MIN.	13.0 ± 0.20
	(inch)	0.039 ± 0.004	0.073 ± 0.004	0.039 ± 0.004	0.061 ± 0.002	7.008 ± 0.04	2.362 MIN.	0.512 ± 0.008

0603 (SOD-523F)	SYMBOL	E	F	P	P ₀	P ₁	T	W	W ₁
	(mm)	1.75 ± 0.10	3.50 ± 0.05	4.00 ± 0.10	4.00 ± 0.10	2.00 ± 0.05	0.23 ± 0.05	8.00 ± 0.20	13.5 MAX.
	(inch)	0.069 ± 0.004	0.138 ± 0.002	0.157 ± 0.004	0.157 ± 0.004	0.079 ± 0.004	0.009 ± 0.002	0.315 ± 0.008	0.531 MAX.

Suggested PAD Layout

SIZE	0603/SOD-523F	
	(mm)	(inch)
A	1.25	0.049
B	0.60	0.024
C	1.00	0.039
D	1.85	0.073
E	0.65	0.026



Standard Package

Case Type	Qty per Reel	Reel Size
	(Pcs)	(inch)
0603/SOD-523F	4000	7