

Features

- RoHS compliant*
- Convex termination style
- 2 isolated elements in an 02 package width
- Resistance tolerance: $\pm 5\%$
- Resistance range: 10 ohms to 1 megohm & zero-ohm jumper
- Sulfur-resistant design

CAY06-AS Series - Sulfur-Resistant Thick Film Chip Arrays

General Characteristics

Characteristic	CAY06-AS
Number of Elements (Isolated)	2
Power Rating @ 70 °C per Resistor	31 mW
Resistor Tolerance	$\pm 5\%$
Resistance Range (E24) plus Zero-ohm Jumper	10 ohms to 1 megohm
Temperature Coefficient of Resistance (TCR)	± 200 ppm
Maximum Overload Voltage	25 V
Maximum Working Voltage	12.5 V
Operating Temperature Range	-55 to +125 °C
Storage Conditions	+5 ~ +40 °C, 25~75 % RH, 1 year
Derating Temperature	+70 °C
Packaging (Paper Tape)	10,000 pcs. per reel
Zero-ohm Jumper: Current Rating Maximum Resistance	1 A per element 100 milliohms

Environmental Characteristics

Specification	Test Method (JIS C 5201-1)	Characteristics
Short Time Overload	Rated voltage x 2.5, 5 seconds	$\pm(2\% + 0.1 \text{ ohm})$
Soldering Heat	+260 °C ± 5 °C, 10 ± 1 seconds	$\pm(1\% + 0.05 \text{ ohm})$
Temperature Cycling	-55 °C (30 minutes) - normal (2~3 minutes) +125 °C (30 minutes) - normal (2~3 minutes), 5 cycles	$\pm(1\% + 0.05 \text{ ohm})$
Moisture Load Life	+40 °C, 90~95 % RH, 1000 hours, 1.5 hours ON, 0.5 hours OFF	$\pm(3\% + 0.1 \text{ ohm})$
Load Life	+70 °C, 1000 hours, 1.5 hours ON, 0.5 hours OFF	$\pm(3\% + 0.1 \text{ ohm})$
Sulfur Test	3 ppm H ₂ S, +50 °C, 90~95 % RH, 100 hours	$\pm(5\% + 0.1 \text{ ohm})$

NOTE: Zero-ohm jumper <100 milliohms.

Soldering Profile

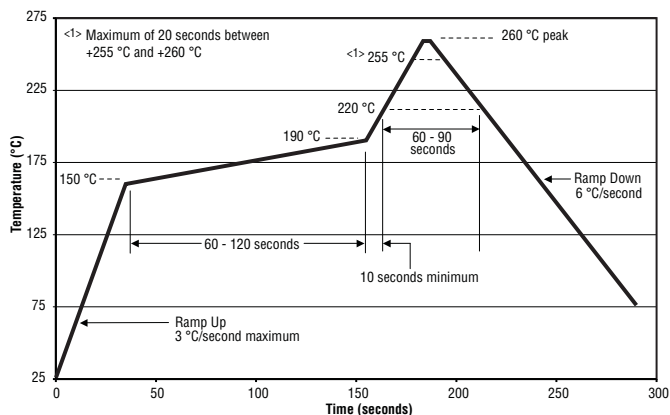

How To Order

CA Y 06 - 103 J 2 AS

Chip Array — CA
 Type — Y
 • Y = Convex
 Model — 06
 • 06 = 02 Package Width
 Resistance Code — 103
 • First two digits are significant, third digit represents number of zeros to follow (example: 103 = 10K ohms)
 • 000 = Zero-ohm jumper
 Resistance Tolerance — J
 • J = $\pm 5\%$
 Resistors — 2
 • 2 = 2 Resistors
 Special Characteristics — AS
 • AS = Sulfur-resistant, Tin-plated terminations (RoHS compliant)

For Standard Values Used in Capacitors, Inductors, and Resistors, [click here](#).

Construction

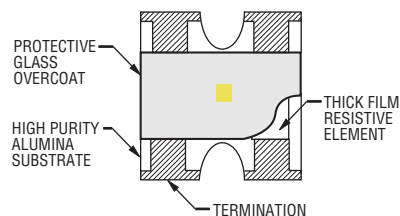

* RoHS Directive 2002/95/EC Jan. 27, 2003 including annex and RoHS Recast 2011/65/EU June 8, 2011.

Specifications are subject to change without notice.

The device characteristics and parameters in this data sheet can and do vary in different applications and actual device performance may vary over time.

Users should verify actual device performance in their specific applications.

CAY06-AS Series - Sulfur-Resistant Thick Film Chip Arrays



Derating Curve

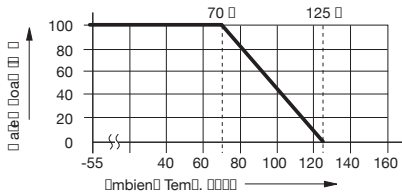

Isolated Circuit

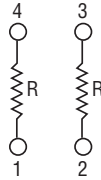

Typical Part Marking

Marking.....Refer to Product Dimensions
Marking Color.....Yellow

Product Dimensions

Dim.	CAY06-AS
L	$\frac{0.85 \pm 0.05}{(0.033 \pm 0.002)}$
W	$\frac{0.60 \pm 0.05}{(0.024 \pm 0.002)}$
T	$\frac{0.35 \pm 0.05}{(0.014 \pm 0.002)}$
P	$\frac{0.50 \pm 0.05}{(0.020 \pm 0.002)}$
A	$\frac{0.37 \pm 0.05}{(0.015 \pm 0.002)}$
B	$\frac{0.11 \pm 0.05}{(0.004 \pm 0.002)}$
G	$\frac{0.17 \pm 0.05}{(0.007 \pm 0.002)}$

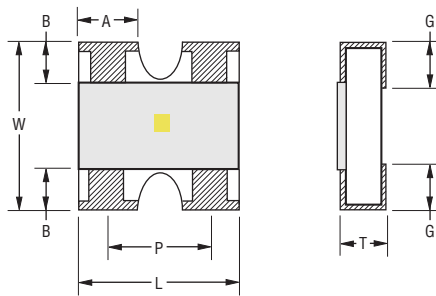

DIMENSIONS: $\frac{\text{MM}}{\text{(INCHES)}}$

Recommended Land Pattern

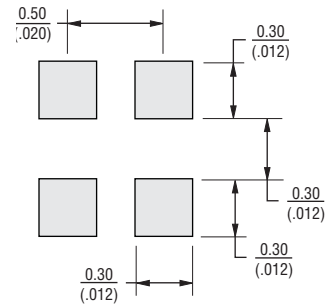

Packaging Specifications

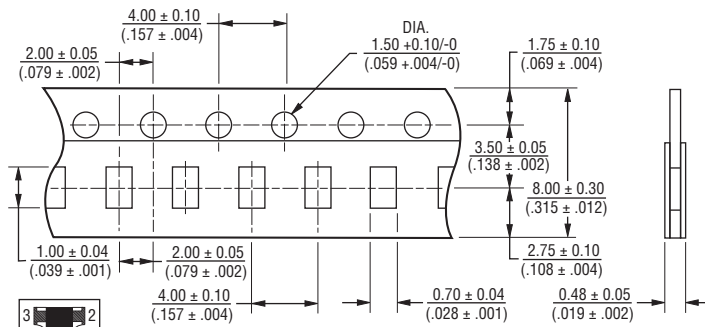

ORIENTATION OF PART IN TAPE

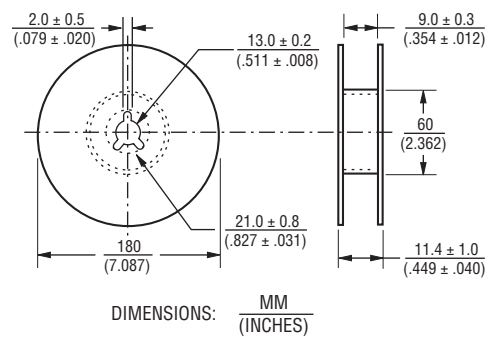

DIMENSIONS: $\frac{\text{MM}}{\text{(INCHES)}}$



Asia-Pacific: Tel: +886-2 2562-4117 • Email: asiacus@bourns.com

EMEA: Tel: +36 88 520 390 • Email: eurocus@bourns.com

The Americas: Tel: +1-951 781-5500 • Email: americus@bourns.com

www.bourns.com