



Bridgelux® Vero® SE 29 Array Series

Product Data Sheet DS123



Introduction

Vero SE



Vero® SE is a revolutionary light source system that integrates Bridgelux's seventh generation COB technology with poke-in connectivity enabling solder-free installation. Vero SE LED light sources streamline assembly processes, lower manufacturing cost, simplify luminaire design, improve light quality and increase design flexibility.

Vero SE is available in four different light emitting surface (LES) configurations that operate reliably over a broad current range. With Vero SE, secondary connector and holder components are not required, allowing for rapid integration of arrays into fixtures and an efficient field replaceable solution. Vero SE arrays deliver increased lumen density for improved beam control and precision lighting with 2 and 3 SDCM color control standards for clean and consistent uniform lighting.

Bridgelux Décor Series is our state of the art color line designed specifically for premium applications, producing unmatched LED light quality with brilliant color-rendering options and offer pleasing and inspiring lighting palettes. Bridgelux Décor Series color points are available on Vero® SE Series, Vero® Series, V Series™ and H Series™.

Décor Series Class A is based on human response testing, providing color points with a combined GAI and CRI metric.

Décor Series™ Food products offer color points developed to address the unique requirements of the food, grocery, and restaurant industries. Highlighting the distinctive colors and nuanced patterns found in meats and breads, the Décor Series Food products are a must have for any butcher counter or bakery.

Décor Series™ Specialty products provide color points developed specifically for the healthcare and entertainment industries. The 5600K cool white color point combined with a CRI of 90 provides the bright white required by these industries.

Décor Series™ Street and Landmark is designed to be a direct replacement for high pressure sodium lamps.

Features

- Poke-in connectivity
- Efficacy of 155 lm/W typical
- Lumen output performance ranges from 5,368 to 37,173 lumens
- Broad range of CCT options from 1750K to 6500K
- CRI options: minimum 65, 70, 80, and 90
- Color control: 2 and 3 SDCM for 2700K-4000K CCT
- Reliable operation at up to 2X nominal drive current
- Radial die pattern and improved lumen density
- Top side part number markings
- No exposed solder pads or electrical connections
- V_f bin code backside marking

Benefits

- Poke-in connectivity enables solderless, connector free installation
- Broad application coverage for interior and exterior lighting
- Flexibility for application driven lighting design requirements
- High quality, true color reproduction
- Uniform consistent white light
- Flexibility in design optimization
- Enhanced ease of use and assembly
- Ability to configure multiple arrays in series and parallel reduces customer driver cost
- Improved inventory management and quality control



Contents

Product Feature Map	2
Product Nomenclature	2
Product Selection Guide	3
Performance at Commonly Used Drive Currents	8
Electrical Characteristics	16
Eye Safety	17
Absolute Maximum Ratings	18
Performance Curves	19
Typical Radiation Pattern	23
Typical Color Spectrum	24
Mechanical Dimensions	25
Color Binning Information	26
Packaging and Labeling	27
Design Resources	29
Precautions	29
Disclaimers	29
About Bridgelux	30

Product Feature Map

Vero SE 29 is the largest form factor in the product family of next generation solid state light sources. In addition to delivering the performance and light quality required for many lighting applications, Vero SE incorporates several

features to simplify the design integration and manufacturing process, accelerate time to market and reduce system costs. Please visit www.bridgelux.com for more information on the Vero SE Series family of products.

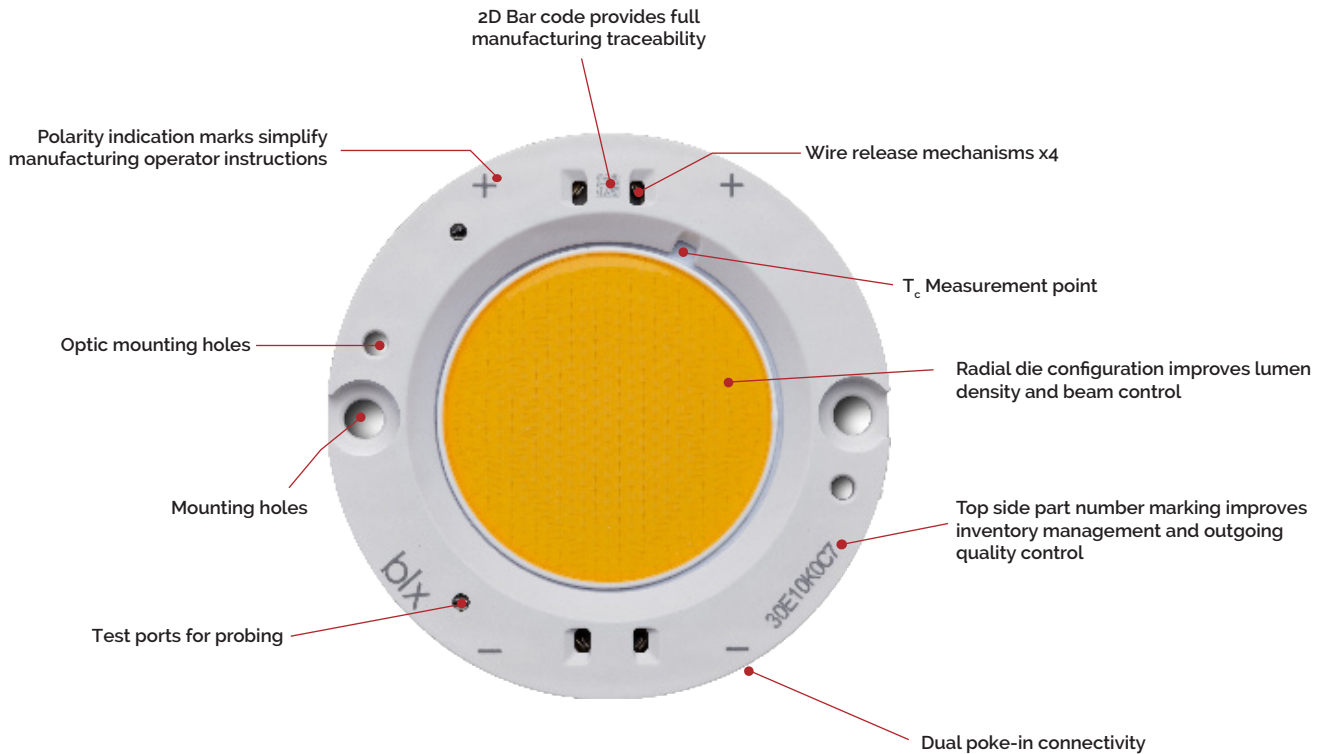

Product Nomenclature

The part number designation for Bridgelux Vero SE LED arrays is explained as follows:

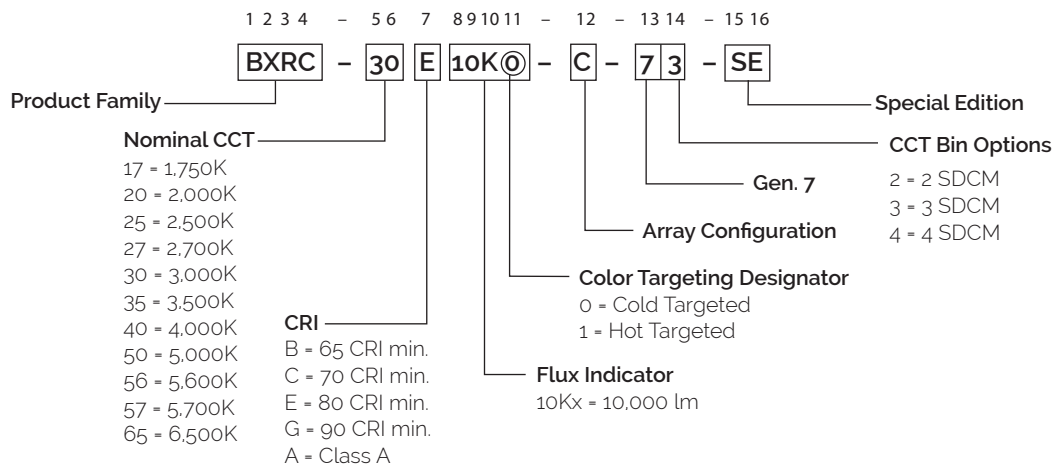

Product Selection Guide

The following product configurations are available:

Table 1: Selection Guide, Pulsed Measurement Data ($T_j = T_c = 25^\circ\text{C}$)

Part Number	Nominal CCT ¹ (K)	CRI ²	Nominal Drive Current ³ (mA)	Typical Pulsed Flux ^{4,5,6} $T_c = 25^\circ\text{C}$ (lm)	Minimum Pulsed Flux ^{6,7} $T_c = 25^\circ\text{C}$ (lm)	Typical V_f (V)	Typical Power (W)	Typical Efficacy (lm/W)
BXRC-17E10K0-B-74-SE	1750	80	1800	8033	7230	52.0	93.6	86
BXRC-17E10K0-C-74-SE	1750	80	1710	10175	9157	69.4	118.7	86
BXRC-17E10K0-D-74-SE	1750	80	2100	6768	6092	37.6	79.0	86
BXRC-20B10K1-C-73-SE	2000	65	1710	17155	15440	69.4	118.7	145
BXRC-20B10K1-D-73-SE	2000	65	2100	11411	10270	37.6	79.0	145
BXRC-25E10K0-B-74-SE	2500	80	1800	12983	11685	52.0	93.6	139
BXRC-25E10K0-C-74-SE	2500	80	1710	16446	14801	69.4	118.7	139
BXRC-25E10K0-D-74-SE	2500	80	2100	10940	9845	37.6	79.0	139
BXRC-27E10K0-B-7X-SE	2700	80	1800	13899	12509	52.0	93.6	148
BXRC-27E10K0-C-7X-SE	2700	80	1710	17605	15844	69.4	118.7	148
BXRC-27E10K0-D-7X-SE	2700	80	2100	11711	10540	37.6	79.0	148
BXRC-27G10K0-B-7X-SE	2700	90	1800	11582	10424	52.0	93.6	124
BXRC-27G10K0-C-7X-SE	2700	90	1710	14671	13204	69.4	118.7	124
BXRC-27G10K0-D-7X-SE	2700	90	2100	9759	8783	37.6	79.0	124
BXRC-30E10K0-B-7X-SE ¹⁰	3000	80	1800	14478	13030	52.0	93.6	155
BXRC-30E10K0-C-7X-SE ¹⁰	3000	80	1710	18339	16505	69.4	118.7	155
BXRC-30E10K0-D-7X-SE ¹⁰	3000	80	2100	12565	10979	37.6	79.0	159
BXRC-30G10K0-B-7X-SE	3000	90	1800	12017	10815	52.0	93.6	128
BXRC-30G10K0-C-7X-SE	3000	90	1710	15221	13699	69.4	118.7	128
BXRC-30G10K0-D-7X-SE	3000	90	2100	10125	9112	37.6	79.0	128
BXRC-30A10K1-B-73-SE ^{8,9}	3000	93	1800	11209	10088	52.0	93.6	120
BXRC-30A10K1-C-73-SE ^{8,9}	3000	93	1710	14197	12778	69.4	118.7	120
BXRC-30A10K1-D-73-SE ^{8,9}	3000	93	2100	9444	8500	37.6	79.0	120
BXRC-35E10K0-B-7X-SE ¹⁰	3500	80	1800	14912	13421	52.0	93.6	159
BXRC-35E10K0-C-7X-SE ¹⁰	3500	80	1710	18889	16999	69.4	118.7	159
BXRC-35E10K0-D-7X-SE ¹⁰	3500	80	2100	12565	11309	37.6	79.0	159
BXRC-35G10K0-B-7X-SE	3500	90	1800	12451	11206	52.0	93.6	133
BXRC-35G10K0-C-7X-SE	3500	90	1710	15771	14194	69.4	118.7	133
BXRC-35G10K0-D-7X-SE	3500	90	2100	10491	9442	37.6	79.0	133
BXRC-35A10K1-B-73-SE ^{8,9}	3500	93	1800	12050	10845	52.0	93.6	129
BXRC-35A10K1-C-73-SE ^{8,9}	3500	93	1710	15263	13737	69.4	118.7	129
BXRC-35A10K1-D-73-SE ^{8,9}	3500	93	2100	10153	9137	37.6	79.0	129

Notes for Table 1:

- Nominal CCT as defined by ANSI C78.377-2011. Products with a CCT of 5000K-6500K are hot targeted to $T_c = 85^\circ\text{C}$.
- CRI values are typical for Decor Series Class A products. CRI values are minimums for all other products. Minimum Rg value for 80 CRI products is 0, the minimum Rg values for 90 CRI products is 50.
- Drive current is referred to as nominal drive current.
- Products tested under pulsed condition (10ms pulse width) at nominal test current where T_j (junction temperature) - T_c (case temperature) - 25°C .
- Typical performance values are provided as a reference only and are not a guarantee of performance.
- Bridgelux maintains a $\pm 7\%$ tolerance on flux measurements.
- Minimum flux values at the nominal test current are guaranteed by 100% test.
- Nominal CCT is defined by the Lighting Research Center's Class A definition. The center of the Class A color bin is on the corresponding isothermal line.
- GAI value is 80. To help ensure optimal fixture level performance, GAI is measured at the fixture level, on axis, at a case temperature of 70°C . GAI may vary depending on fixture design and performance.
- SKUs meet DLC premium (Outdoor Mid Output) requirements under certain system level conditions.

Product Selection Guide

Table 1: Selection Guide, Pulsed Measurement Data ($T_j = T_c = 25^\circ\text{C}$) (continued)

Part Number	Nominal CCT ¹ (K)	CRI ²	Nominal Drive Current ³ (mA)	Typical Pulsed Flux ^{4,5,6} $T_c = 25^\circ\text{C}$ (lm)	Minimum Pulsed Flux ^{6,7} $T_c = 25^\circ\text{C}$ (lm)	Typical V_f (V)	Typical Power (W)	Typical Efficacy (lm/W)
BXRC-40E10K0-B-7X-SE ¹⁰	4000	80	1800	15057	13551	52.0	93.6	161
BXRC-40E10K0-C-7X-SE ¹⁰	4000	80	1710	19072	17165	69.4	118.7	161
BXRC-40E10K0-D-7X-SE ¹⁰	4000	80	2100	12687	11418	37.6	79.0	161
BXRC-40G10K0-B-7X-SE	4000	90	1800	12885	11597	52.0	93.6	138
BXRC-40G10K0-C-7X-SE	4000	90	1710	16321	14689	69.4	118.7	138
BXRC-40G10K0-D-7X-SE	4000	90	2100	10857	9772	37.6	79.0	138
BXRC-40A10K1-B-73-SE ^{9,9}	4000	93	1800	12890	11601	52.0	93.6	138
BXRC-40A10K1-C-73-SE ^{9,9}	4000	93	1710	16327	14694	69.4	118.7	138
BXRC-40A10K1-D-73-SE ^{9,9}	4000	93	2100	10861	9775	37.6	79.0	138
BXRC-50C10K1-B-74-SE ¹⁰	5000	70	1800	16505	14855	52.0	93.6	176
BXRC-50C10K1-C-74-SE ¹⁰	5000	70	1710	20906	18816	69.4	118.7	176
BXRC-50C10K1-D-74-SE ¹⁰	5000	70	2100	13907	12516	37.6	79.0	176
BXRC-50E10K1-B-74-SE ¹⁰	5000	80	1800	15515	13963	52.0	93.6	166
BXRC-50E10K1-C-74-SE ¹⁰	5000	80	1710	19652	17687	69.4	118.7	166
BXRC-50E10K1-D-74-SE ¹⁰	5000	80	2100	13072	11766	37.6	79.0	166
BXRC-50G10K1-B-74-SE	5000	90	1800	13204	11883	52.0	93.6	141
BXRC-50G10K1-C-74-SE	5000	90	1710	16725	15052	69.4	118.7	141
BXRC-50G10K1-D-74-SE	5000	90	2100	11125	10013	37.6	79.0	141
BXRC-56G10K1-B-74-SE	5600	90	1800	13824	12442	52.0	93.6	148
BXRC-56G10K1-C-74-SE	5600	90	1710	17510	15760	69.4	118.7	148
BXRC-56G10Kx-D-74-SE	5600	90	2100	11648	10483	37.6	79.0	148
BXRC-57C10K1-B-74-SE ¹⁰	5700	70	1800	15926	14333	52.0	93.6	170
BXRC-57C10K1-C-74-SE ¹⁰	5700	70	1710	20172	18155	69.4	118.7	170
BXRC-57C10K1-D-74-SE ¹⁰	5700	70	2100	13419	12077	37.6	79.0	170
BXRC-57E10K1-B-74-SE ¹⁰	5700	80	1800	15781	14202	52.0	93.6	169
BXRC-57E10K1-C-74-SE ¹⁰	5700	80	1710	19989	17990	69.4	118.7	168
BXRC-57E10K1-D-74-SE ¹⁰	5700	80	2100	13297	11967	37.6	79.0	168
BXRC-65C10K1-B-74-SE ¹⁰	6500	70	1800	16215	14593	52.0	93.6	173
BXRC-65C10K1-C-74-SE ¹⁰	6500	70	1710	20539	18486	69.4	118.7	173
BXRC-65C10K1-D-74-SE ¹⁰	6500	70	2100	13663	12296	37.6	79.0	173
BXRC-65E10K1-B-74-SE ¹⁰	6500	80	1800	16070	14464	52.0	93.6	172
BXRC-65E10K1-C-74-SE ¹⁰	6500	80	1710	20356	18320	69.4	118.7	172
BXRC-65E10K1-D-74-SE ¹⁰	6500	80	2100	13541	12186	37.6	79.0	171

Notes for Table 1:

- Nominal CCT as defined by ANSI C78.377-2011. Products with a CCT of 5000K-6500K are hot targeted to $T_c = 85^\circ\text{C}$.
- CRI values are typical for Decor Series Class A products. CRI values are minimums for all other products. Minimum Rg value for 80 CRI products is 0, the minimum Rg values for 90 CRI products is 50.
- Drive current is referred to as nominal drive current.
- Products tested under pulsed condition (10ms pulse width) at nominal test current where T_j (junction temperature) - T_c (case temperature) = 25°C .
- Typical performance values are provided as a reference only and are not a guarantee of performance.
- Bridgelux maintains a $\pm 7\%$ tolerance on flux measurements.
- Minimum flux values at the nominal test current are guaranteed by 100% test.
- Nominal CCT is defined by the Lighting Research Center's Class A definition. The center of the Class A color bin is on the corresponding isothermal line.
- GAI value is 80. To help ensure optimal fixture level performance, GAI is measured at the fixture level, on axis, at a case temperature of 70°C . GAI may vary depending on fixture design and performance.
- SKUs meet DLC premium (Outdoor Mid Output) requirements under certain system level conditions.

Product Selection Guide

Table 2: Selection Guide. Stabilized DC Performance ($T_c = 70^\circ\text{C}$) ^{7,8}

Part Number	Nominal CCT ¹ (K)	GAI ²	CRI ³	Nominal Drive Current ⁴ (mA)	Typical DC Flux ^{5,6} $T_c = 70^\circ\text{C}$ (lm)	Minimum DC Flux ^{6,9} $T_c = 70^\circ\text{C}$ (lm)	Typical V_f (V)	Typical Power (W)	Typical Efficacy (lm/W)
BXRC-30A10K1-B-73-SE	3000	80	93	1800	10424	9382	50.9	91.6	114
BXRC-30A10K1-C-73-SE	3000	80	93	1710	13204	11884	67.9	116.1	114
BXRC-30A10K1-D-73-SE	3000	80	93	2100	8783	7905	36.8	77.3	114
BXRC-35A10K1-B-73-SE	3500	80	93	1800	11206	10086	50.9	91.6	122
BXRC-35A10K1-C-73-SE	3500	80	93	1710	14194	12775	67.9	116.1	122
BXRC-35A10K1-D-73-SE	3500	80	93	2100	9442	8498	36.8	77.3	122
BXRC-40A10K1-B-73-SE	4000	80	93	1800	11987	10789	50.9	91.6	131
BXRC-40A10K1-C-73-SE	4000	80	93	1710	15184	13666	67.9	116.1	131
BXRC-40A10K1-D-73-SE	4000	80	93	2100	10101	9090	36.8	77.3	131

Notes for Table 2:

- Nominal CCT is defined by the Lighting Research Center's Class A definition. The center of the Class A color bin is on the corresponding isothermal line.
- To help ensure optimal fixture level performance, GAI is measured at the fixture level, on axis, at a case temperature of 70°C . GAI may vary depending on fixture design and performance.
- CRI Values are specified as typical.
- Drive current is referred to as nominal drive current.
- Typical performance values are provided as a reference only and are not a guarantee of performance.
- Bridgelux maintains a $\pm 7\%$ tolerance on flux measurements.
- Typical stabilized DC performance values are provided as reference only and are not a guarantee of performance.
- Typical performance is estimated based on operation under DC (direct current) with LED array mounted onto a heat sink with thermal interface material and the case temperature maintained at specified temperature. Based on Bridgelux test setup, values may vary depending on the thermal design of the luminaire and/or the exposed environment to which the product is subjected.
- Minimum flux values at elevated temperatures are provided for reference only and are not guaranteed by 100% production testing. Based on Bridgelux test setup, values may vary depending on the thermal design of the luminaire and/or the exposed environment to which the product is subjected.

Product Selection Guide

Table 3: Selection Guide, Stabilized DC Performance ($T_c = 85^\circ\text{C}$)^{4,5}

Part Number	Nominal CCT ¹ (K)	CRI ²	Nominal Drive Current ³ (mA)	Typical DC Flux ^{4,5} $T_c = 85^\circ\text{C}$ (lm)	Minimum DC Flux ⁶ $T_c = 85^\circ\text{C}$ (lm)	Typical V_f (V)	Typical Power (W)	Typical Efficacy (lm/W)
BXRC-17E10K0-B-74-SE	1750	80	1800	7230	6507	50.7	91.2	79
BXRC-17E10K0-C-74-SE	1750	80	1710	9157	8241	68.1	116.4	79
BXRC-17E10K0-D-74-SE	1750	80	2100	6091	5483	36.6	76.8	79
BXRC-20B10K1-C-73-SE	2000	65	1710	15440	13896	68.1	116.4	133
BXRC-20B10K1-D-73-SE	2000	65	2100	10270	9243	36.6	76.8	134
BXRC-25E10K0-B-74-SE	2500	80	1800	11685	10516	50.7	91.2	128
BXRC-25E10K0-C-74-SE	2500	80	1710	14801	13321	68.1	116.4	127
BXRC-25E10K0-D-74-SE	2500	80	2100	9846	8861	36.6	76.8	128
BXRC-27E10K0-B-7X-SE	2700	80	1800	12509	11258	50.7	91.2	137
BXRC-27E10K0-C-7X-SE	2700	80	1710	15845	14260	68.1	116.4	136
BXRC-27E10K0-D-7X-SE	2700	80	2100	10540	9486	36.6	76.8	137
BXRC-27G10K0-B-7X-SE	2700	90	1800	10424	9381	50.7	91.2	114
BXRC-27G10K0-C-7X-SE	2700	90	1710	13204	11884	68.1	116.4	113
BXRC-27G10K0-D-7X-SE	2700	90	2100	8783	7905	36.6	76.8	114
BXRC-30E10K0-B-7X-SE	3000	80	1800	13030	11727	50.7	91.2	143
BXRC-30E10K0-C-7X-SE	3000	80	1710	16505	14854	68.1	116.4	142
BXRC-30E10K0-D-7X-SE	3000	80	2100	11309	9882	36.6	76.8	147
BXRC-30G10K0-B-7X-SE	3000	90	1800	10815	9733	50.7	91.2	119
BXRC-30G10K0-C-7X-SE	3000	90	1710	13699	12329	68.1	116.4	118
BXRC-30G10K0-D-7X-SE	3000	90	2100	9113	8201	36.6	76.8	119
BXRC-30A10K1-B-73-SE ^{7,8}	3000	93	1800	10088	9079	50.7	91.2	111
BXRC-30A10K1-C-73-SE ^{7,8}	3000	93	1710	12778	11500	68.1	116.4	110
BXRC-30A10K1-D-73-SE ^{7,8}	3000	93	2100	8500	7650	36.6	76.8	111
BXRC-35E10K0-B-7X-SE	3500	80	1800	13421	12079	50.7	91.2	147
BXRC-35E10K0-C-7X-SE	3500	80	1710	17000	15299	68.1	116.4	146
BXRC-35E10K0-D-7X-SE	3500	80	2100	11308	10178	36.6	76.8	147
BXRC-35G10K0-B-7X-SE	3500	90	1800	11206	10085	50.7	91.2	123
BXRC-35G10K0-C-7X-SE	3500	90	1710	14194	12775	68.1	116.4	122
BXRC-35G10K0-D-7X-SE	3500	90	2100	9442	8498	36.6	76.8	123
BXRC-35A10K1-B-73-SE ^{7,8}	3500	93	1800	10845	9760	50.7	91.2	119
BXRC-35A10K1-C-73-SE ^{7,8}	3500	93	1710	13736	12363	68.1	116.4	118
BXRC-35A10K1-D-73-SE ^{7,8}	3500	93	2100	9137	8223	36.6	76.8	119

Notes for Table 3:

- Nominal CCT as defined by ANSI C78.377-2011. Products with a CCT of 5000K-6500K are hot targeted to $T_c = 85^\circ\text{C}$.
- CRI values are typical for Decor Series Class A products. CRI values are minimums for all other products. Minimum Rg value for 80 CRI products is 0, the minimum Rg values for 90 CRI products is 50.
- Drive current is referred to as nominal drive current.
- Typical stabilized DC performance values are provided as reference only and are not a guarantee of performance.
- Typical performance is estimated based on operation under DC (direct current) with LED array mounted onto a heat sink with thermal interface material and the case temperature maintained at 85°C . Based on Bridgelux test setup, values may vary depending on the thermal design of the luminaire and/or the exposed environment to which the product is subjected.
- Minimum flux values at elevated temperatures are provided for reference only and are not guaranteed by 100% production testing. Based on Bridgelux test setup, values may vary depending on the thermal design of the luminaire and/or the exposed environment to which the product is subjected.
- Nominal CCT is defined by the Lighting Research Center's Class A definition. The center of the Class A color bin is on the corresponding isothermal line.
- GAI value is 80. To help ensure optimal fixture level performance, GAI is measured at the fixture level, on axis, at a case temperature of 70°C . GAI may vary depending on fixture design and performance.

Product Selection Guide

Table 3: Selection Guide, Stabilized DC Performance ($T_c = 85^\circ\text{C}$)^{4,5} (continued)

Part Number	Nominal CCT ² (K)	CRI ²	Nominal Drive Current ³ (mA)	Typical DC Flux ^{4,5} $T_c = 85^\circ\text{C}$ (lm)	Minimum DC Flux ⁶ $T_c = 85^\circ\text{C}$ (lm)	Typical V_f (V)	Typical Power (W)	Typical Efficacy (lm/W)
BXRC-40E10K0-B-7X-SE	4000	80	1800	13551	12196	50.7	91.2	149
BXRC-40E10K0-C-7X-SE	4000	80	1710	17165	15448	68.1	116.4	147
BXRC-40E10K0-D-7X-SE	4000	80	2100	11418	10277	36.6	76.8	149
BXRC-40G10K0-B-7X-SE	4000	90	1800	11597	10437	50.7	91.2	127
BXRC-40G10K0-C-7X-SE	4000	90	1710	14689	13220	68.1	116.4	126
BXRC-40G10K0-D-7X-SE	4000	90	2100	9771	8794	36.6	76.8	127
BXRC-40A10K1-B-73-SE ^{7,8}	4000	93	1800	11601	10441	50.7	91.2	127
BXRC-40A10K1-C-73-SE ^{7,8}	4000	93	1710	14694	13225	68.1	116.4	126
BXRC-40A10K1-D-73-SE ^{7,8}	4000	93	2100	9775	8797	36.6	76.8	127
BXRC-50C10K1-B-74-SE	5000	70	1800	14854	13369	50.7	91.2	163
BXRC-50C10K1-C-74-SE	5000	70	1710	18815	16934	68.1	116.4	162
BXRC-50C10K1-D-74-SE	5000	70	2100	12516	11264	36.6	76.8	163
BXRC-50E10K1-B-74-SE	5000	80	1800	13963	12567	50.7	91.2	153
BXRC-50E10K1-C-74-SE	5000	80	1710	17686	15918	68.1	116.4	152
BXRC-50E10K1-D-74-SE	5000	80	2100	11765	10589	36.6	76.8	153
BXRC-50G10K1-B-74-SE	5000	90	1800	11883	10695	50.7	91.2	130
BXRC-50G10K1-C-74-SE	5000	90	1710	15052	13547	68.1	116.4	129
BXRC-50G10K1-D-74-SE	5000	90	2100	10013	9012	36.6	76.8	130
BXRC-56G10K1-B-74-SE	5600	90	1800	12442	11198	50.7	91.2	136
BXRC-56G10K1-C-74-SE	5600	90	1710	15759	14184	68.1	116.4	135
BXRC-56G10Kx-D-74-SE	5600	90	2100	10483	9434	36.6	76.8	137
BXRC-57C10K1-B-74-SE	5700	70	1800	14333	12900	50.7	91.2	157
BXRC-57C10K1-C-74-SE	5700	70	1710	18155	16340	68.1	116.4	156
BXRC-57C10K1-D-74-SE	5700	70	2100	12077	10869	36.6	76.8	157
BXRC-57E10K1-B-74-SE	5700	80	1800	14203	12782	50.7	91.2	156
BXRC-57E10K1-C-74-SE	5700	80	1710	17990	16191	68.1	116.4	155
BXRC-57E10K1-D-74-SE	5700	80	2100	11967	10770	36.6	76.8	156
BXRC-65C10K1-B-74-SE	6500	70	1800	14594	13134	50.7	91.2	160
BXRC-65C10K1-C-74-SE	6500	70	1710	18485	16637	68.1	116.4	159
BXRC-65C10K1-D-74-SE	6500	70	2100	12297	11067	36.6	76.8	160
BXRC-65E10K1-B-74-SE	6500	80	1800	14463	13017	50.7	91.2	159
BXRC-65E10K1-C-74-SE	6500	80	1710	18320	16488	68.1	116.4	157
BXRC-65E10K1-D-74-SE	6500	80	2100	12187	10968	36.6	76.8	159

Notes for Table 3:

- Nominal CCT as defined by ANSI C78.377-2011. Products with a CCT of 5000K-6500K are hot targeted to $T_c = 85^\circ\text{C}$.
- CRI values are typical for Decor Series Class A products. CRI values are minimums for all other products. Minimum Rg value for 80 CRI products is 0, the minimum Rg values for 90 CRI products is 50.
- Drive current is referred to as nominal drive current.
- Typical stabilized DC performance values are provided as reference only and are not a guarantee of performance.
- Typical performance is estimated based on operation under DC (direct current) with LED array mounted onto a heat sink with thermal interface material and the case temperature maintained at 85°C . Based on Bridgelux test setup, values may vary depending on the thermal design of the luminaire and/or the exposed environment to which the product is subjected.
- Minimum flux values at elevated temperatures are provided for reference only and are not guaranteed by 100% production testing. Based on Bridgelux test setup, values may vary depending on the thermal design of the luminaire and/or the exposed environment to which the product is subjected.
- Nominal CCT is defined by the Lighting Research Center's Class A definition. The center of the Class A color bin is on the corresponding isothermal line.
- GAI value is 80. To help ensure optimal fixture level performance, GAI is measured at the fixture level, on axis, at a case temperature of 70°C . GAI may vary depending on fixture design and performance.

Performance at Commonly Used Drive Currents

Vero SE LED arrays are tested to the specifications shown using the nominal drive currents in Table 1. Vero SE may also be driven at other drive currents dependent on specific application design requirements. The performance at any drive current can be derived from the current vs. voltage characteristics shown in Figures 1, 2 & 3 and the flux vs. current characteristics shown in Figures 4, 5 & 6. The performance at commonly used drive currents is summarized in Table 4.

Table 4: Product Performance at Commonly Used Drive Currents

Part Number	CRI	Drive Current ¹ (mA)	Typical V_f $T_c = 25^\circ\text{C}$ (V)	Typical Power $T_c = 25^\circ\text{C}$ (W)	Typical Flux ² $T_c = 25^\circ\text{C}$ (lm)	Typical DC Flux ³ $T_c = 85^\circ\text{C}$ (lm)	Typical Efficacy $T_c = 25^\circ\text{C}$ (lm/W)
BXRC-17E10K0-B-74-SE	80	900	49.6	44.7	4170	3807	93
		1200	50.5	60.6	5491	4991	91
		1800	52.0	93.6	8033	7230	86
		2700	54.1	146.1	11579	10327	79
		3600	55.8	201.0	14820	13058	74
BXRC-17E10K0-C-74-SE	80	855	66.2	56.6	5780	5500	102
		1140	67.3	76.7	7346	6776	96
		1710	69.4	118.7	10175	9157	86
		2565	72.1	185.0	14434	12414	78
		3420	74.4	254.6	18091	15202	71
BXRC-17E10K0-D-74-SE	80	1050	35.4	37.2	3723	3627	100
		1400	36.2	50.6	4791	4459	95
		2100	37.6	79.0	6768	6091	86
		3150	39.5	124.4	9635	8119	77
		4200	41.2	172.9	12144	9917	70
BXRC-20B10K1-C-73-SE	65	855	66.2	56.6	9745	9273	172
		1140	67.3	76.7	12386	11425	161
		1710	69.4	118.7	17155	15440	145
		2565	72.1	185.0	24336	20931	132
		3420	74.4	254.6	30503	25631	120
BXRC-20B10K1-D-73-SE	65	1050	35.4	37.2	6277	6116	169
		1400	36.2	50.6	8078	7518	160
		2100	37.6	79.0	11411	10270	145
		3150	39.5	124.4	16245	13688	131
		4200	41.2	172.9	20475	16719	118
BXRC-25E10K0-B-74-SE	80	900	49.6	44.7	6740	6152	151
		1200	50.5	60.6	8875	8067	147
		1800	52.0	93.6	12983	11685	139
		2700	54.1	146.1	18715	16691	128
		3600	55.8	201.0	23954	21105	119
BXRC-25E10K0-C-74-SE	80	855	66.2	56.6	9342	8890	165
		1140	67.3	76.7	11874	10953	155
		1710	69.4	118.7	16446	14801	139
		2565	72.1	185.0	23330	20066	126
		3420	74.4	254.6	29242	24572	115
BXRC-25E10K0-D-74-SE	80	1050	35.4	37.2	6017	5863	162
		1400	36.2	50.6	7744	7207	153
		2100	37.6	79.0	10940	9846	139
		3150	39.5	124.4	15574	13123	125
		4200	41.2	172.9	19629	16029	113

Notes for Table 4:

1. Alternate drive currents are provided for reference only and are not a guarantee of performance.
2. Bridgelux maintains a $\pm 7\%$ tolerance on flux measurements.
3. Typical stabilized DC performance values are provided as reference only and are not a guarantee of performance.

Performance at Commonly Used Drive Currents

Table 4: Product Performance at Commonly Used Drive Currents (Continued)

Part Number	CRI	Drive Current ¹ (mA)	Typical V _f T _c = 25°C (V)	Typical Power T _c = 25°C (W)	Typical Flux ² T _c = 25°C (lm)	Typical DC Flux ³ T _c = 85°C (lm)	Typical Efficacy T _c = 25°C (lm/W)
BXRC-27E10Ko-B-7x-SE	80	900	49.6	44.7	7215	6586	162
		1200	50.5	60.6	9500	8636	157
		1800	52.0	93.6	13899	12509	148
		2700	54.1	146.1	20035	17867	137
		3600	55.8	201.0	25642	22593	128
BXRC-27E10Ko-C-7x-SE	80	855	66.2	56.6	10001	9517	177
		1140	67.3	76.7	12711	11725	166
		1710	69.4	118.7	17605	15845	148
		2565	72.1	185.0	24975	21480	135
		3420	74.4	254.6	31304	26304	123
BXRC-27E10Ko-D-7x-SE	80	1050	35.4	37.2	6442	6276	173
		1400	36.2	50.6	8290	7715	164
		2100	37.6	79.0	11711	10540	148
		3150	39.5	124.4	16672	14048	134
		4200	41.2	172.9	21013	17159	122
BXRC-27G10Ko-B-7x-SE	90	900	49.6	44.7	6013	5488	135
		1200	50.5	60.6	7917	7197	131
		1800	52.0	93.6	11582	10424	124
		2700	54.1	146.1	16696	14890	114
		3600	55.8	201.0	21369	18827	106
BXRC-27G10Ko-C-7x-SE	90	855	66.2	56.6	8334	7931	147
		1140	67.3	76.7	10593	9771	138
		1710	69.4	118.7	14671	13204	124
		2565	72.1	185.0	20812	17900	113
		3420	74.4	254.6	26086	21920	102
BXRC-27G10Ko-D-7x-SE	90	1050	35.4	37.2	5368	5230	144
		1400	36.2	50.6	6908	6429	136
		2100	37.6	79.0	9759	8783	124
		3150	39.5	124.4	13894	11707	112
		4200	41.2	172.9	17511	14299	101
BXRC-30E10Ko-B-7x-SE	80	900	49.6	44.7	7516	6861	168
		1200	50.5	60.6	9896	8996	163
		1800	52.0	93.6	14478	13030	155
		2700	54.1	146.1	20870	18612	143
		3600	55.8	201.0	26711	23534	133
BXRC-30E10Ko-C-7x-SE	80	855	66.2	56.6	10418	9913	184
		1140	67.3	76.7	13241	12214	173
		1710	69.4	118.7	18339	16505	155
		2565	72.1	185.0	26016	22375	141
		3420	74.4	254.6	32608	27400	128
BXRC-30E10Ko-D-7x-SE	80	1050	35.4	37.2	6912	6734	186
		1400	36.2	50.6	8895	8278	176
		2100	37.6	79.0	12565	11309	159
		3150	39.5	124.4	17889	15073	144
		4200	41.2	172.9	22546	18411	130

Notes for Table 4:

1. Alternate drive currents are provided for reference only and are not a guarantee of performance.
2. Bridgelux maintains a ± 7% tolerance on flux measurements.
3. Typical stabilized DC performance values are provided as reference only and are not a guarantee of performance.

Performance at Commonly Used Drive Currents

Table 4: Product Performance at Commonly Used Drive Currents (Continued)

Part Number	CRI	Drive Current ¹ (mA)	Typical V _f T _c = 25°C (V)	Typical Power T _c = 25°C (W)	Typical Flux ² T _c = 25°C (lm)	Typical DC Flux ³ T _c = 85°C (lm)	Typical Efficacy T _c = 25°C (lm/W)
BXRC-30G10Ko-B-7x-SE	90	900	49.6	44.7	6238	5694	140
		1200	50.5	60.6	8214	7466	136
		1800	52.0	93.6	12017	10815	128
		2700	54.1	146.1	17322	15448	119
		3600	55.8	201.0	22170	19533	110
BXRC-30G10Ko-C-7x-SE	90	855	66.2	56.6	8647	8228	153
		1140	67.3	76.7	10990	10137	143
		1710	69.4	118.7	15221	13699	128
		2565	72.1	185.0	21593	18572	117
		3420	74.4	254.6	27065	22742	106
BXRC-30G10Ko-D-7x-SE	90	1050	35.4	37.2	5569	5427	150
		1400	36.2	50.6	7168	6670	142
		2100	37.6	79.0	10125	9113	128
		3150	39.5	124.4	14415	12146	116
		4200	41.2	172.9	18167	14835	105
BXRC-30A10K1-B-73-SE	93	900	49.6	44.7	5819	5312	130
		1200	50.5	60.6	7662	6965	127
		1800	52.0	93.6	11209	10088	120
		2700	54.1	146.1	16157	14409	111
		3600	55.8	201.0	20680	18220	103
BXRC-30A10K1-C-73-SE	93	855	66.2	56.6	8065	7675	143
		1140	67.3	76.7	10251	9456	134
		1710	69.4	118.7	14197	12778	120
		2565	72.1	185.0	20141	17323	109
		3420	74.4	254.6	25245	21212	99
BXRC-30A10K1-D-73-SE	93	1050	35.4	37.2	5195	5062	140
		1400	36.2	50.6	6686	6222	132
		2100	37.6	79.0	9444	8500	120
		3150	39.5	124.4	13445	11329	108
		4200	41.2	172.9	16946	13838	98
BXRC-35E10Ko-B-7x-SE	80	900	49.6	44.7	7741	7066	173
		1200	50.5	60.6	10193	9266	168
		1800	52.0	93.6	14912	13421	159
		2700	54.1	146.1	21496	19170	147
		3600	55.8	201.0	27512	24240	137
BXRC-35E10Ko-C-7x-SE	80	855	66.2	56.6	10730	10211	190
		1140	67.3	76.7	13638	12580	178
		1710	69.4	118.7	18889	17000	159
		2565	72.1	185.0	26796	23047	145
		3420	74.4	254.6	33586	28222	132
BXRC-35E10Ko-D-7x-SE	80	1050	35.4	37.2	6911	6734	186
		1400	36.2	50.6	8895	8278	176
		2100	37.6	79.0	12565	11308	159
		3150	39.5	124.4	17888	15072	144
		4200	41.2	172.9	22545	18410	130

Notes for Table 4:

1. Alternate drive currents are provided for reference only and are not a guarantee of performance.
2. Bridgelux maintains a ± 7% tolerance on flux measurements.
3. Typical stabilized DC performance values are provided as reference only and are not a guarantee of performance.

Performance at Commonly Used Drive Currents

Table 4: Product Performance at Commonly Used Drive Currents (Continued)

Part Number	CRI	Drive Current ¹ (mA)	Typical V_f $T_c = 25^\circ\text{C}$ (V)	Typical Power $T_c = 25^\circ\text{C}$ (W)	Typical Flux ² $T_c = 25^\circ\text{C}$ (lm)	Typical DC Flux ³ $T_c = 85^\circ\text{C}$ (lm)	Typical Efficacy $T_c = 25^\circ\text{C}$ (lm/W)
BXRC-35G10K0-B-7x-SE	90	900	49.6	44.7	6464	5900	145
		1200	50.5	60.6	8511	7736	141
		1800	52.0	93.6	12451	11206	133
		2700	54.1	146.1	17948	16006	123
		3600	55.8	201.0	22971	20239	114
BXRC-35G10K0-C-7x-SE	90	855	66.2	56.6	8959	8525	158
		1140	67.3	76.7	11387	10504	148
		1710	69.4	118.7	15771	14194	133
		2565	72.1	185.0	22373	19243	121
		3420	74.4	254.6	28043	23564	110
BXRC-35G10K0-D-7x-SE	90	1050	35.4	37.2	5771	5623	155
		1400	36.2	50.6	7427	6912	147
		2100	37.6	79.0	10491	9442	133
		3150	39.5	124.4	14936	12585	120
		4200	41.2	172.9	18824	15372	109
BXRC-35A10K1-B-73-SE	93	900	49.6	44.7	6255	5710	140
		1200	50.5	60.6	8237	7487	136
		1800	52.0	93.6	12050	10845	129
		2700	54.1	146.1	17370	15490	119
		3600	55.8	201.0	22231	19587	111
BXRC-35A10K1-C-73-SE	93	855	66.2	56.6	8670	8251	153
		1140	67.3	76.7	11020	10165	144
		1710	69.4	118.7	15263	13736	129
		2565	72.1	185.0	21652	18622	117
		3420	74.4	254.6	27139	22804	107
BXRC-35A10K1-D-73-SE	93	1050	35.4	37.2	5584	5441	150
		1400	36.2	50.6	7187	6689	142
		2100	37.6	79.0	10153	9137	129
		3150	39.5	124.4	14454	12178	116
		4200	41.2	172.9	18217	14876	105
BXRC-40E10K0-B-7x-SE	80	900	49.6	44.7	7816	7135	175
		1200	50.5	60.6	10292	9356	170
		1800	52.0	93.6	15057	13551	161
		2700	54.1	146.1	21704	19356	149
		3600	55.8	201.0	27779	24476	138
BXRC-40E10K0-C-7x-SE	80	855	66.2	56.6	10834	10310	191
		1140	67.3	76.7	13770	12702	180
		1710	69.4	118.7	19072	17165	161
		2565	72.1	185.0	27056	23270	146
		3420	74.4	254.6	33912	28496	133
BXRC-40E10K0-D-7x-SE	80	1050	35.4	37.2	6978	6800	188
		1400	36.2	50.6	8981	8358	177
		2100	37.6	79.0	12687	11418	161
		3150	39.5	124.4	18062	15219	145
		4200	41.2	172.9	22764	18589	132

Notes for Table 4:

1. Alternate drive currents are provided for reference only and are not a guarantee of performance.
2. Bridgelux maintains a $\pm 7\%$ tolerance on flux measurements.
3. Typical stabilized DC performance values are provided as reference only and are not a guarantee of performance.

Performance at Commonly Used Drive Currents

Table 4: Product Performance at Commonly Used Drive Currents (Continued)

Part Number	CRI	Drive Current ¹ (mA)	Typical V _f T _c = 25°C (V)	Typical Power T _c = 25°C (W)	Typical Flux ² T _c = 25°C (lm)	Typical DC Flux ³ T _c = 85°C (lm)	Typical Efficacy T _c = 25°C (lm/W)
BXRC-40G10Ko-B-7x-SE	90	900	49.6	44.7	6689	6106	150
		1200	50.5	60.6	8808	8006	145
		1800	52.0	93.6	12885	11597	138
		2700	54.1	146.1	18574	16565	127
		3600	55.8	201.0	23773	20945	118
BXRC-40G10Ko-C-7x-SE	90	855	66.2	56.6	9272	8823	164
		1140	67.3	76.7	11784	10870	154
		1710	69.4	118.7	16321	14689	138
		2565	72.1	185.0	23154	19914	125
		3420	74.4	254.6	29021	24386	114
BXRC-40G10Ko-D-7x-SE	90	1050	35.4	37.2	5972	5819	160
		1400	36.2	50.6	7686	7153	152
		2100	37.6	79.0	10857	9771	138
		3150	39.5	124.4	15457	13024	124
		4200	41.2	172.9	19481	15908	113
BXRC-40A10K1-B-73-SE	93	900	49.6	44.7	6691	6108	150
		1200	50.5	60.6	8811	8009	145
		1800	52.0	93.6	12890	11601	138
		2700	54.1	146.1	18580	16570	127
		3600	55.8	201.0	23781	20953	118
BXRC-40A10K1-C-73-SE	93	855	66.2	56.6	9275	8826	164
		1140	67.3	76.7	11788	10874	154
		1710	69.4	118.7	16327	14694	138
		2565	72.1	185.0	23162	19921	125
		3420	74.4	254.6	29031	24394	114
BXRC-40A10K1-D-73-SE	93	1050	35.4	37.2	5974	5821	161
		1400	36.2	50.6	7688	7155	152
		2100	37.6	79.0	10861	9775	138
		3150	39.5	124.4	15462	13028	124
		4200	41.2	172.9	19487	15913	113
BXRC-50C10K1-B-74-SE	70	900	49.6	44.7	8568	7821	192
		1200	50.5	60.6	11282	10255	186
		1800	52.0	93.6	16505	14854	176
		2700	54.1	146.1	23791	21218	163
		3600	55.8	201.0	30450	26829	151
BXRC-50C10K1-C-74-SE	70	855	66.2	56.6	11876	11301	210
		1140	67.3	76.7	15094	13924	197
		1710	69.4	118.7	20906	18815	176
		2565	72.1	185.0	29658	25508	160
		3420	74.4	254.6	37173	31236	146
BXRC-50C10K1-D-74-SE	70	1050	35.4	37.2	7649	7453	206
		1400	36.2	50.6	9845	9162	194
		2100	37.6	79.0	13907	12516	176
		3150	39.5	124.4	19798	16682	159
		4200	41.2	172.9	24953	20376	144

Notes for Table 4:

1. Alternate drive currents are provided for reference only and are not a guarantee of performance.
2. Bridgelux maintains a ± 7% tolerance on flux measurements.
3. Typical stabilized DC performance values are provided as reference only and are not a guarantee of performance.

Performance at Commonly Used Drive Currents

Table 4: Product Performance at Commonly Used Drive Currents (Continued)

Part Number	CRI	Drive Current ¹ (mA)	Typical V_f $T_c = 25^\circ\text{C}$ (V)	Typical Power $T_c = 25^\circ\text{C}$ (W)	Typical Flux ² $T_c = 25^\circ\text{C}$ (lm)	Typical DC Flux ³ $T_c = 85^\circ\text{C}$ (lm)	Typical Efficacy $T_c = 25^\circ\text{C}$ (lm/W)
BXRC-50E10K1-B-74-SE	80	900	49.6	44.7	8054	7352	180
		1200	50.5	60.6	10605	9640	175
		1800	52.0	93.6	15515	13963	166
		2700	54.1	146.1	22364	19945	153
		3600	55.8	201.0	28623	25219	142
BXRC-50E10K1-C-74-SE	80	855	66.2	56.6	11163	10623	197
		1140	67.3	76.7	14189	13088	185
		1710	69.4	118.7	19652	17686	166
		2565	72.1	185.0	27878	23977	151
		3420	74.4	254.6	34943	29362	137
BXRC-50E10K1-D-74-SE	80	1050	35.4	37.2	7190	7006	193
		1400	36.2	50.6	9254	8612	183
		2100	37.6	79.0	13072	11765	166
		3150	39.5	124.4	18610	15681	150
		4200	41.2	172.9	23456	19154	136
BXRC-50G10K1-B-74-SE	90	900	49.6	44.7	6854	6257	153
		1200	50.5	60.6	9025	8204	149
		1800	52.0	93.6	13204	11883	141
		2700	54.1	146.1	19033	16974	130
		3600	55.8	201.0	24360	21463	121
BXRC-50G10K1-C-74-SE	90	855	66.2	56.6	9501	9041	168
		1140	67.3	76.7	12076	11139	157
		1710	69.4	118.7	16725	15052	141
		2565	72.1	185.0	23726	20406	128
		3420	74.4	254.6	29738	24989	117
BXRC-50G10K1-D-74-SE	90	1050	35.4	37.2	6120	5963	164
		1400	36.2	50.6	7876	7329	156
		2100	37.6	79.0	11125	10013	141
		3150	39.5	124.4	15839	13345	127
		4200	41.2	172.9	19962	16301	115
BXRC-56G10K1-B-74-SE	90	900	49.6	44.7	7177	6551	161
		1200	50.5	60.6	9449	8590	156
		1800	52.0	93.6	13824	12442	148
		2700	54.1	146.1	19928	17772	136
		3600	55.8	201.0	25505	22472	127
BXRC-56G10K1-C-74-SE	90	855	66.2	56.6	9947	9465	176
		1140	67.3	76.7	12643	11662	165
		1710	69.4	118.7	17510	15759	148
		2565	72.1	185.0	24840	21364	134
		3420	74.4	254.6	31135	26162	122
BXRC-56G10Kx-D-74-SE	90	1050	35.4	37.2	6407	6243	172
		1400	36.2	50.6	8245	7674	163
		2100	37.6	79.0	11648	10483	148
		3150	39.5	124.4	16582	13972	133
		4200	41.2	172.9	20900	17066	121

Notes for Table 4:

1. Alternate drive currents are provided for reference only and are not a guarantee of performance.
2. Bridgelux maintains a $\pm 7\%$ tolerance on flux measurements.
3. Typical stabilized DC performance values are provided as reference only and are not a guarantee of performance.

Performance at Commonly Used Drive Currents

Table 4: Product Performance at Commonly Used Drive Currents (Continued)

Part Number	CRI	Drive Current ¹ (mA)	Typical V_f $T_c = 25^\circ\text{C}$ (V)	Typical Power $T_c = 25^\circ\text{C}$ (W)	Typical Flux ² $T_c = 25^\circ\text{C}$ (lm)	Typical DC Flux ³ $T_c = 85^\circ\text{C}$ (lm)	Typical Efficacy $T_c = 25^\circ\text{C}$ (lm/W)
BXRC-57C10K1-B-74-SE	70	900	49.6	44.7	8267	7547	185
		1200	50.5	60.6	10886	9895	180
		1800	52.0	93.6	15926	14333	170
		2700	54.1	146.1	22957	20473	157
		3600	55.8	201.0	29382	25888	146
BXRC-57C10K1-C-74-SE	70	855	66.2	56.6	11459	10905	203
		1140	67.3	76.7	14565	13435	190
		1710	69.4	118.7	20172	18155	170
		2565	72.1	185.0	28617	24613	155
		3420	74.4	254.6	35869	30140	141
BXRC-57C10K1-D-74-SE	70	1050	35.4	37.2	7381	7192	198
		1400	36.2	50.6	9499	8840	188
		2100	37.6	79.0	13419	12077	170
		3150	39.5	124.4	19104	16097	154
		4200	41.2	172.9	24077	19661	139
BXRC-57E10K1-B-74-SE	80	900	49.6	44.7	8192	7478	183
		1200	50.5	60.6	10787	9805	178
		1800	52.0	93.6	15781	14203	169
		2700	54.1	146.1	22748	20287	156
		3600	55.8	201.0	29115	25652	145
BXRC-57E10K1-C-74-SE	80	855	66.2	56.6	11355	10805	201
		1140	67.3	76.7	14432	13313	188
		1710	69.4	118.7	19989	17990	168
		2565	72.1	185.0	28357	24389	153
		3420	74.4	254.6	35543	29866	140
BXRC-57E10K1-D-74-SE	80	1050	35.4	37.2	7314	7126	197
		1400	36.2	50.6	9413	8760	186
		2100	37.6	79.0	13297	11967	168
		3150	39.5	124.4	18930	15950	152
		4200	41.2	172.9	23859	19483	138
BXRC-65C10K1-B-74-SE	70	900	49.6	44.7	8418	7684	188
		1200	50.5	60.6	11084	10075	183
		1800	52.0	93.6	16215	14594	173
		2700	54.1	146.1	23374	20845	160
		3600	55.8	201.0	29916	26358	149
BXRC-65C10K1-C-74-SE	70	855	66.2	56.6	11668	11103	206
		1140	67.3	76.7	14830	13679	193
		1710	69.4	118.7	20539	18485	173
		2565	72.1	185.0	29137	25060	158
		3420	74.4	254.6	36521	30688	143
BXRC-65C10K1-D-74-SE	70	1050	35.4	37.2	7515	7323	202
		1400	36.2	50.6	9672	9001	191
		2100	37.6	79.0	13663	12297	173
		3150	39.5	124.4	19451	16389	156
		4200	41.2	172.9	24515	20019	142

Notes for Table 4:

1. Alternate drive currents are provided for reference only and are not a guarantee of performance.
2. Bridgelux maintains a $\pm 7\%$ tolerance on flux measurements.
3. Typical stabilized DC performance values are provided as reference only and are not a guarantee of performance.

Performance at Commonly Used Drive Currents

Table 4: Product Performance at Commonly Used Drive Currents (Continued)

Part Number	CRI	Drive Current ¹ (mA)	Typical V _f T _c = 25°C (V)	Typical Power T _c = 25°C (W)	Typical Flux ² T _c = 25°C (lm)	Typical DC Flux ³ T _c = 85°C (lm)	Typical Efficacy T _c = 25°C (lm/W)
BXRC-65E10K1-B-74-SE	80	900	49.6	44.7	8343	7615	187
		1200	50.5	60.6	10985	9985	181
		1800	52.0	93.6	16070	14463	172
		2700	54.1	146.1	23165	20659	159
		3600	55.8	201.0	29649	26123	147
BXRC-65E10K1-C-74-SE	80	855	66.2	56.6	11564	11004	204
		1140	67.3	76.7	14697	13557	192
		1710	69.4	118.7	20356	18320	172
		2565	72.1	185.0	28877	24837	156
		3420	74.4	254.6	36195	30414	142
BXRC-65E10K1-D-74-SE	80	1050	35.4	37.2	7448	7257	200
		1400	36.2	50.6	9586	8921	189
		2100	37.6	79.0	13541	12187	171
		3150	39.5	124.4	19277	16243	155
		4200	41.2	172.9	24296	19840	140

Notes for Table 4:

1. Alternate drive currents are provided for reference only and are not a guarantee of performance.
2. Bridgelux maintains a ± 7% tolerance on flux measurements.
3. Typical stabilized DC performance values are provided as reference only and are not a guarantee of performance.

Electrical Characteristics

Table 5: Electrical Characteristics

Part Number	Drive Current (mA)	Forward Voltage Pulsed, $T_c = 25^\circ\text{C}$ (V) ^{1, 2, 3, 8}			Typical Coefficient of Forward Voltage ⁴ $\Delta V_f / \Delta T_c$ (mV/ $^\circ\text{C}$)	Typical Thermal Resistance Junction to Case ^{5,6} R_{j-c} ($^\circ\text{C}/\text{W}$)	Driver Selection Voltages ⁷ (V)	
		Minimum	Typical	Maximum			V_f Min. Hot $T_c = 105^\circ\text{C}$ (V)	V_f Max. Cold $T_c = -40^\circ\text{C}$ (V)
BXRC-xxx10Kx-B-7x-SE	1800	48.1	52.0	55.9	-24.9	0.06	46.1	57.5
	3600	51.7	55.8	60.0	-24.9	0.07	49.7	61.6
BXRC-xxx10Kx-C-7x-SE	1710	64.2	69.4	74.6	-33.2	0.04	61.5	76.8
	3420	68.8	74.4	80.0	-33.2	0.05	66.2	82.2
BXRC-xxx10Kx-D-7x-SE	2100	34.8	37.6	40.4	-17.4	0.06	33.4	41.6
	4200	38.1	41.2	44.3	-17.4	0.07	36.7	45.4

Notes for Table 5:

- Parts are tested in pulsed conditions. $T_c = 25^\circ\text{C}$. Pulse width is 10ms.
- Voltage minimum and maximum are provided for reference only and are not a guarantee of performance.
- Bridgelux maintains a tester tolerance of $\pm 0.10\text{V}$ on forward voltage measurements.
- Typical coefficient of forward voltage tolerance is $\pm 0.1\text{mV}$ for nominal current.
- Thermal resistance values are based from test data of a 3000K 80 CRI product.
- Thermal resistance value was calculated using total electrical input power; optical power was not subtracted from input power. The thermal interface material used during testing is not included in the thermal resistance value.
- V_f min hot and max cold values are provided as reference only and are not guaranteed by test. These values are provided to aid in driver design and selection over the operating range of the product.
- This product has been designed and manufactured per IEC 62031:2014. This product has passed dielectric withstand voltage testing at 1160 V. The working voltage designated for the insulation is 80V d.c. The maximum allowable voltage across the array must be determined in the end product application.

Eye Safety

Table 6: Eye Safety Risk Group (RG) Classifications

Part Number	Drive Current ⁵ (mA)	CCT ⁵			
		2700K/3000K	4000K ²	5000K ³	6500K ⁴
BXRC-xxx10Kx-B-7x-SE	1800	RG1	RG1	RG1	RG1
	2700	RG1	RG1	RG2	RG2
	3600	RG1	RG1	RG2	RG2
BXRC-xxx10Kx-C-7x-SE	1710	RG1	RG1	RG1	RG2
	2565	RG1	RG1	RG2	RG2
	3420	RG1	RG2	RG2	RG2
BXRC-xxx10Kx-D-7x-SE	2100	RG1	RG1	RG1	RG1
	3150	RG1	RG1	RG1	RG2
	4200	RG1	RG1	RG2	RG2

Notes for Table 6:

1. Eye safety classification for the use of Bridgelux Vero SE Series LED arrays is in accordance with specification IEC/TR 62778: Application of IEC 62471 for the assessment of blue light hazard to light sources and luminaires.
2. For products classified as RG2 at 4000K, $E_{thr} = 1847.5$ lx.
3. For products classified as RG2 at 5000K $E_{thr} = 1315.8$ lx.
4. For products classified as RG2 at 6500K, $E_{thr} = 1124.5$ lx.
5. Please contact your Bridgelux sales representative for E_{thr} values at specific drive currents and CCTs not listed.

Absolute Maximum Ratings

Table 7: Maximum Ratings

Parameter	Maximum Rating		
LED Junction Temperature (T _j)	125°C		
Storage Temperature	-40°C to +105°C		
Operating Case Temperature ¹ (T _c)	105°C		
	BXRC-xxx10Kx-B-7x-SE	BXRC-xxx10Kx-C-7x-SE	BXRC-xxx10Kx-D-7x-SE
Maximum Drive Current ³	3600mA	3420mA	4200mA
Maximum Peak Pulsed Drive Current ⁴	5140mA	4890mA	6000mA
Maximum Reverse Voltage ⁵	-90V	-120V	-65V

Notes for Table 7:

1. For IEC 62717 requirement, please consult your Bridgelux sales representative.
2. Refer to Bridgelux Application Note AN121: Assembly Considerations for Bridgelux Vero SE LED Arrays.
3. Arrays may be driven at higher currents however lumen maintenance may be reduced.
4. Bridgelux recommends a maximum duty cycle of 10% and pulse width of 20 ms when operating LED Arrays at maximum peak pulsed current specified. Maximum peak pulsed currents indicate values where LED Arrays can be driven without catastrophic failures.
5. Light emitting diodes are not designed to be driven in reverse voltage and will not produce light under this condition. Maximum rating provided for reference only.

Performance Curves

Figure 1: Vero SE 29B Drive Current vs. Voltage

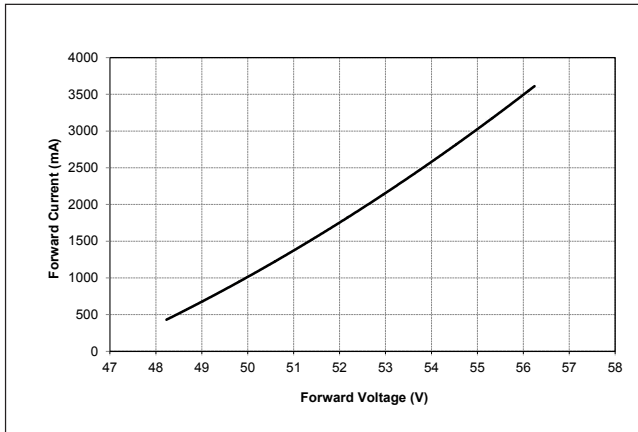

Figure 2: Vero SE 29C Drive Current vs. Voltage

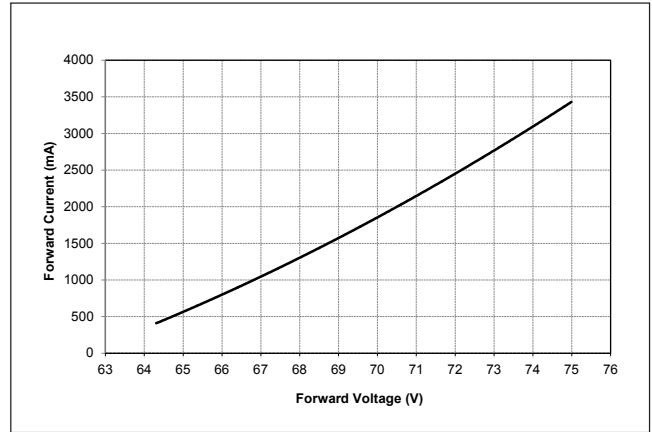

Figure 3: Vero SE 29D Drive Current vs. Voltage

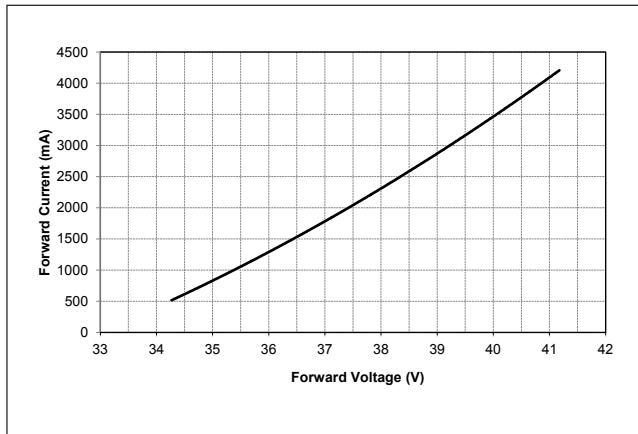

Figure 4: Vero SE 29B Typical Relative Flux vs. Current

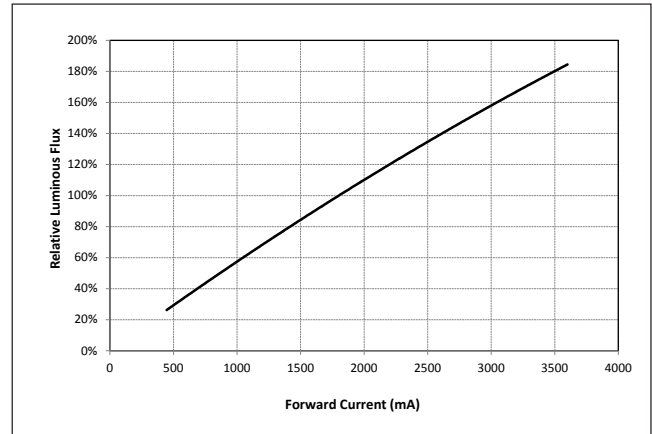

Figure 5: Vero SE 29C Typical Relative Flux vs. Current

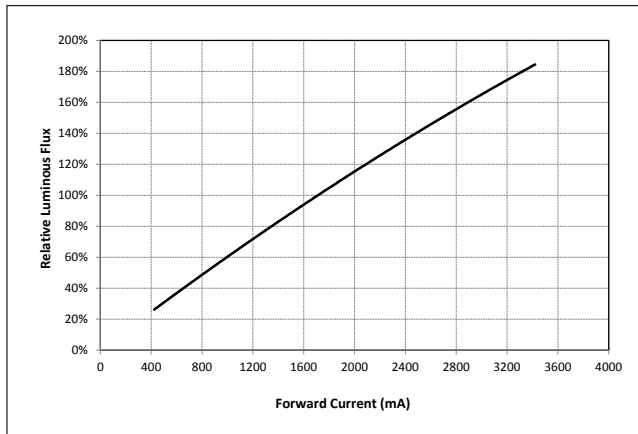
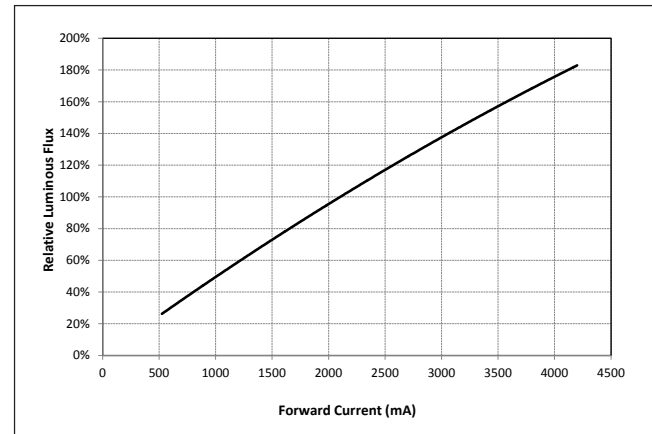

Figure 6: Vero SE 29D Typical Relative Flux vs. Current



Notes for Figures 1-6:

1. Bridgelux does not recommend driving high power LEDs at low currents. Doing so may produce unpredictable results. Pulse width modulation (PWM) is recommended for dimming effects.
2. Products tested under pulsed condition (10ms pulse width) at nominal test current where T_J (junction temperature) = T_C (case temperature) = 25°C.

Performance Curves

Figure 7: Typical DC Flux vs. Case Temperature

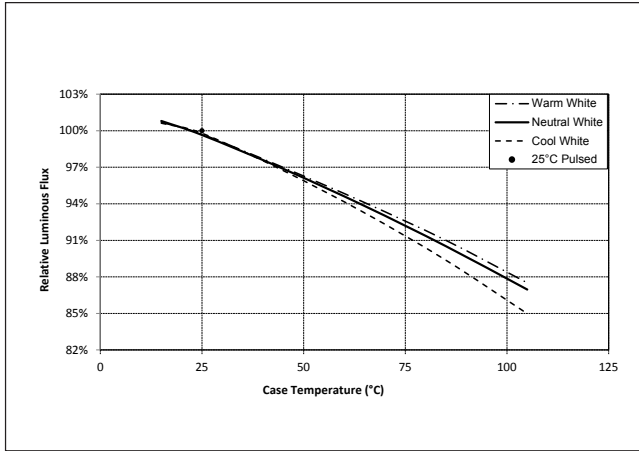

Figure 8: Typical DC ccy Shift vs. Case Temperature

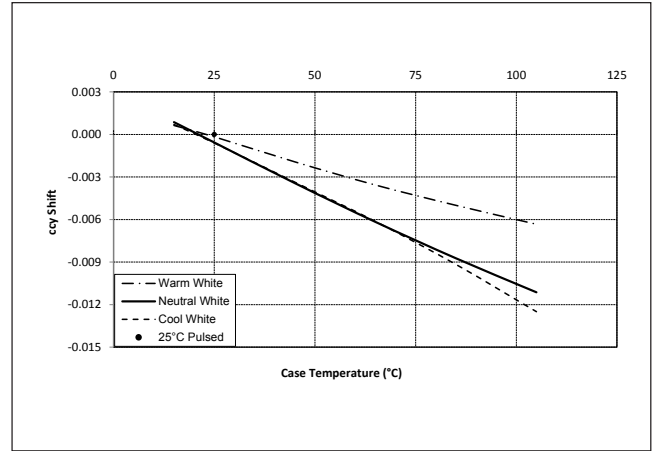

Figure 9: Typical DC ccx Shift vs. Case Temperature

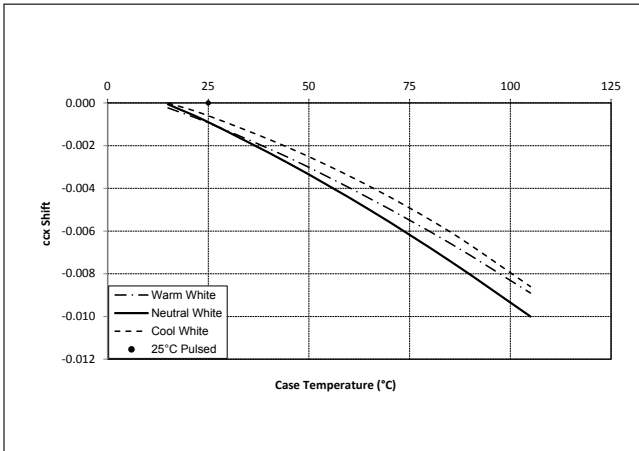
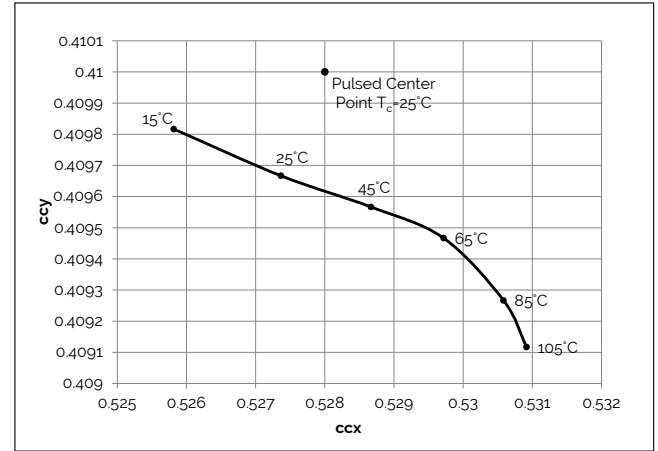

Figure 10: 2000K, 65 CRI Color Shift vs. Case Temperature



Notes for Figures 7-9:

1. Characteristics shown for warm white based on 3000K and 80 CRI.
2. Characteristics shown for neutral white based on 4000K and 80 CRI.
3. Characteristics shown for cool white based on 5000K and 70 CRI.
4. For other color SKUs, the shift in color will vary. Please contact your Bridgelux Sales Representative for more information.

Performance Curves

Figure 11: 1750K Color Shift vs. Case Temperature¹

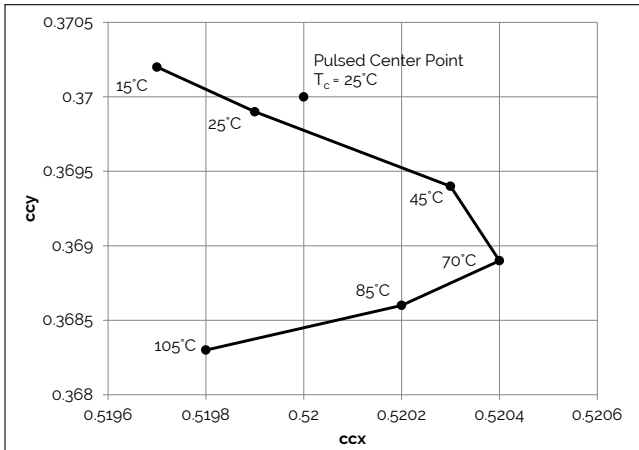

Figure 12: 2500K Color Shift vs. Case Temperature¹

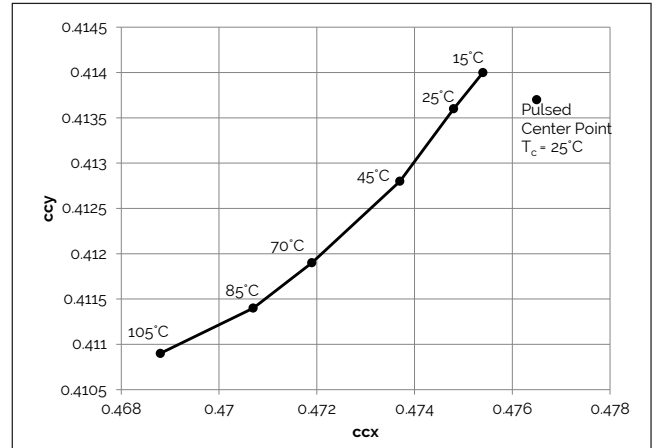

Figure 13: 5600K Color Shift vs. Case Temperature^{1,3}

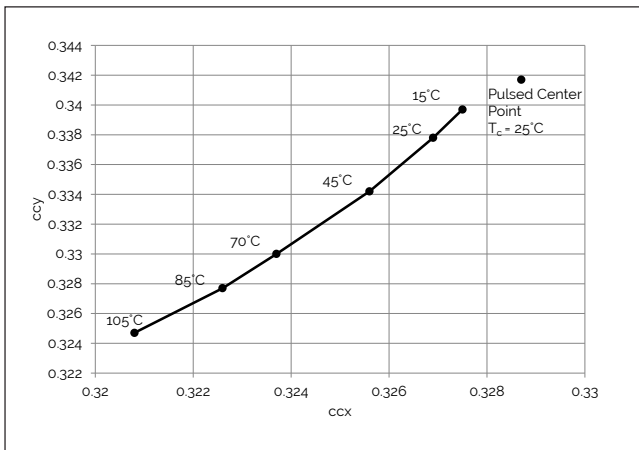

Figure 14: 3000K Class A Color Shift vs. Case Temperature¹

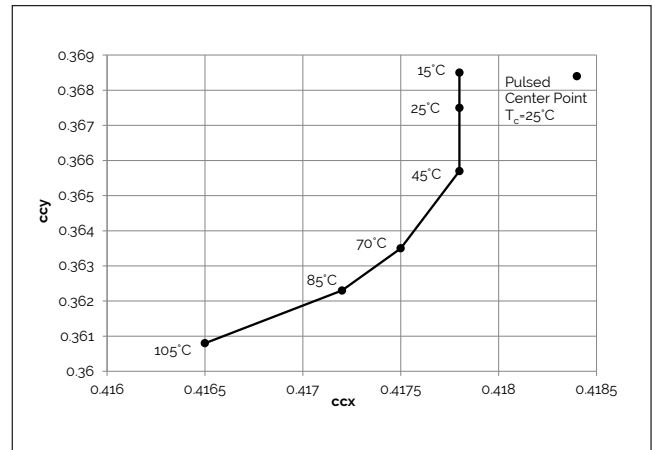

Figure 15: 3500K Class A Color Shift vs. Case Temperature¹

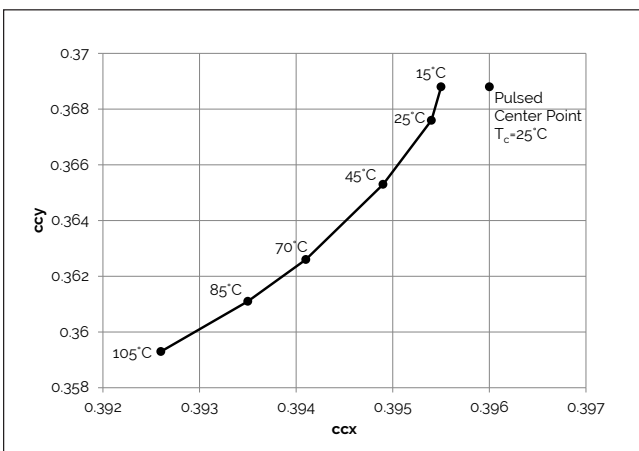
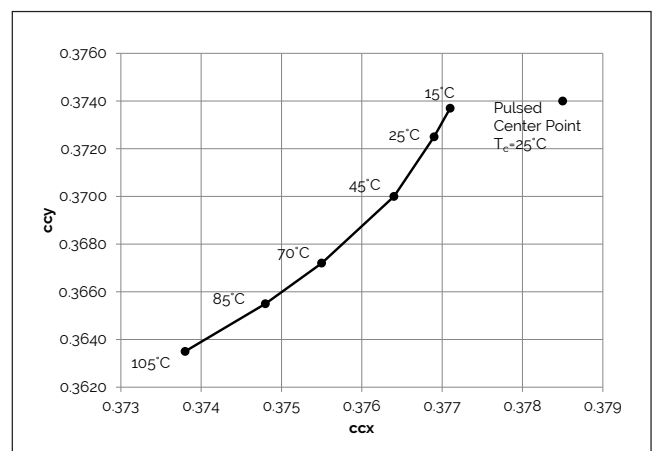

Figure 16: 4000K Class A Color Shift vs. Case Temperature¹



Note for Figures 10-16:

1. Measurements made under DC test conditions at the nominal drive current.
2. Typical color shift is shown with a tolerance of ± 0.002 .
3. Color shift shown for product hot targeted at $T_c = 85^\circ\text{C}$

Performance Curves

Figure 17: Vero SE 29D Drive Current Derating Curve

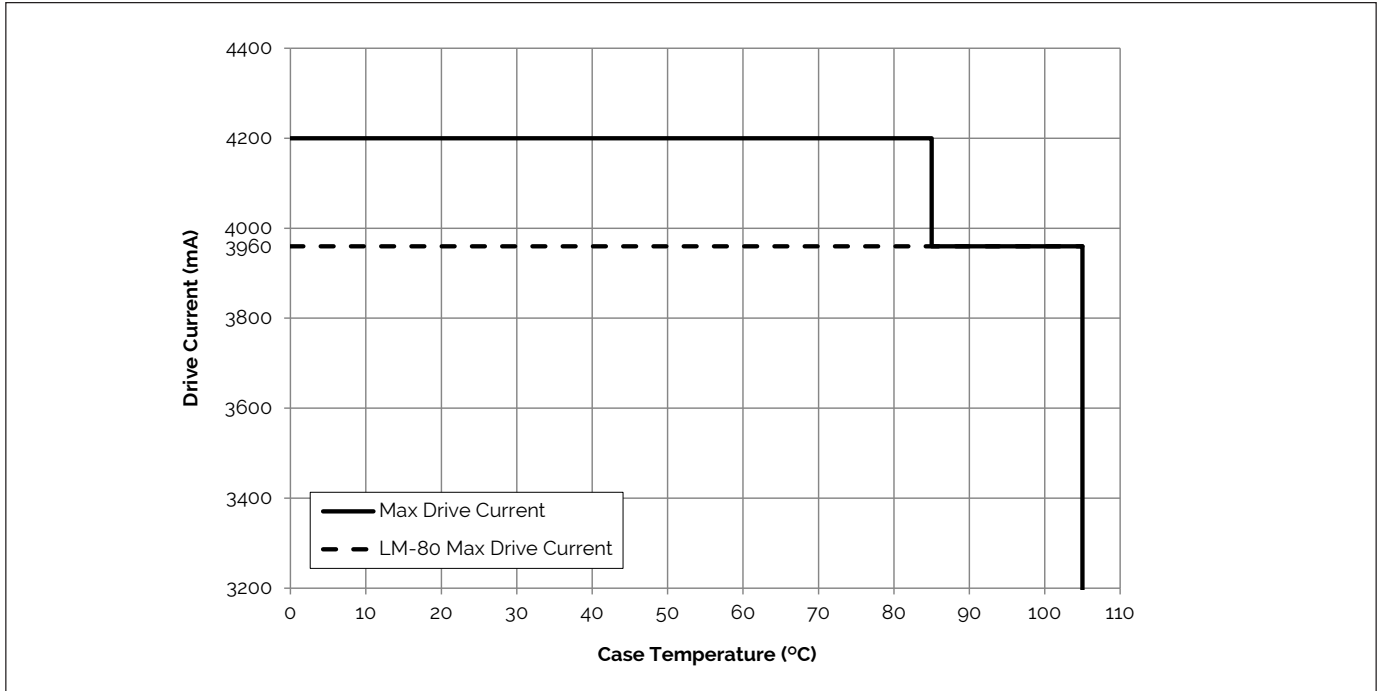

Notes for Figure 17:

1. The maximum allowable drive current for the Vero 29D product is dependent on the operating case temperature. Please refer to the Product Feature Map (page 2) for the location of the T_c Point
2. LM-80 Max Drive Current must not be exceeded in order to meet LM-80 lifetime projections.
3. Lumen maintenance (L70) and lifetime predictions are valid for drive current and case temperature conditions used for LM-80 testing as included in the applicable LM-80 test report for these products. Contact your Bridgelux sales representative for LM-80 report.

Typical Radiation Pattern

Figure 18: Typical Spatial Radiation Pattern

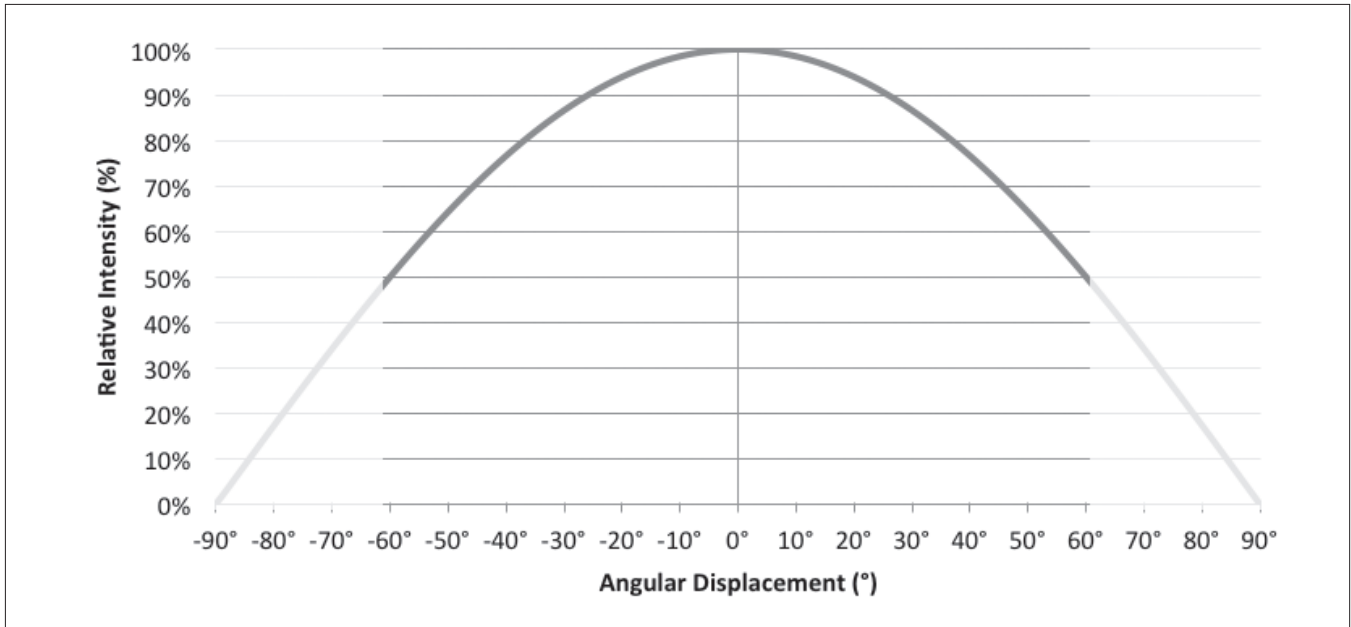

Note for Figure 18:

1. Typical viewing angle is 120°.
2. The viewing angle is defined as the off axis angle from the centerline where intensity is ½ of the peak value.

Figure 19: Typical Polar Radiation Pattern

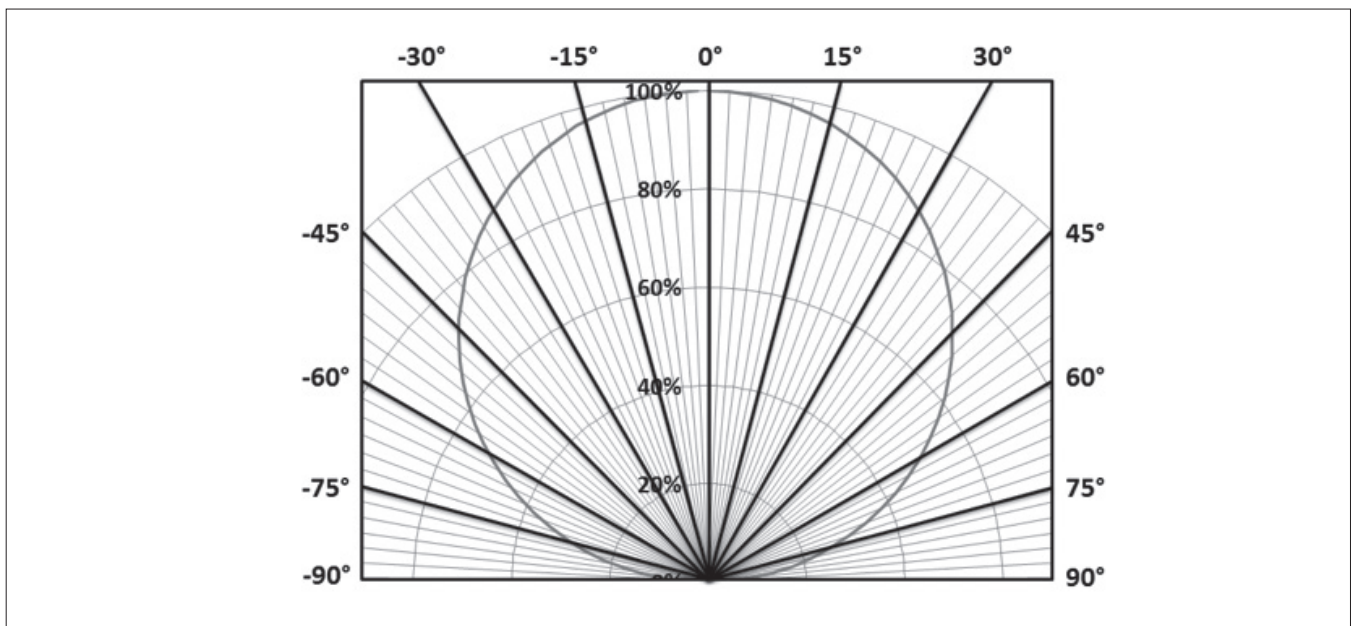

Typical Color Spectrum

Figure 20: Typical Color Spectrum

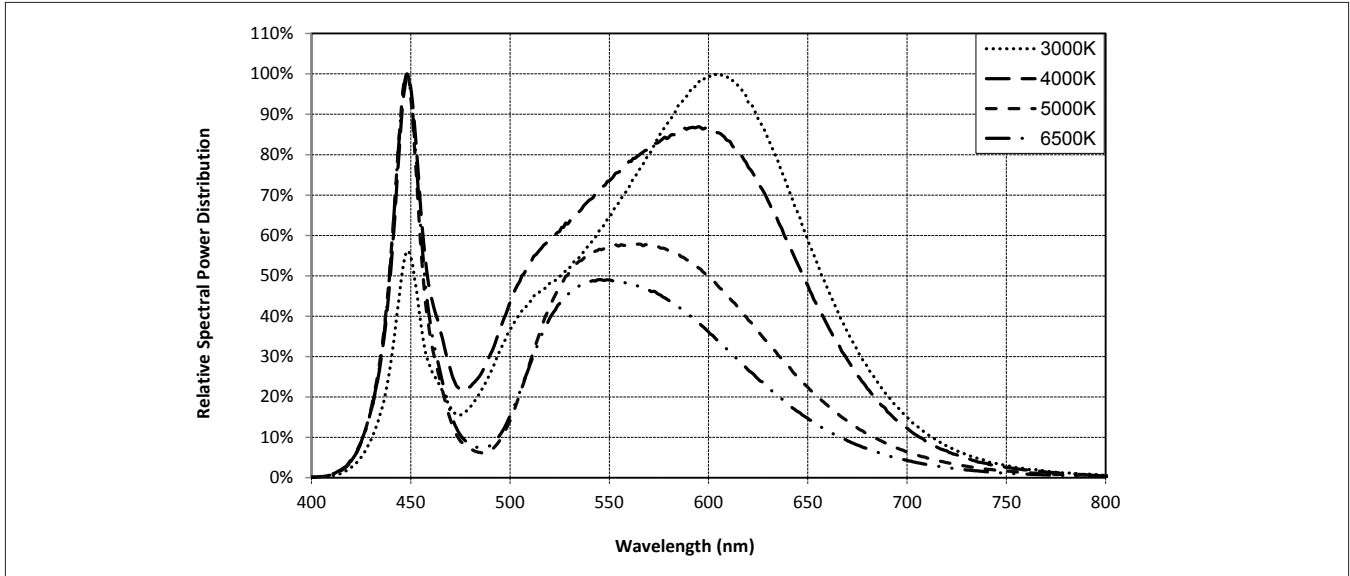

Note for Figure 20:

1. Color spectra measured at nominal current for $T_j = T_c = 25^\circ\text{C}$.
2. Color spectra shown is 3000K and 80 CRI.
3. Color spectra shown is 4000K and 80 CRI.
4. Color spectra shown is 5000K and 70 CRI.
4. Color spectra shown is 6500K and 70 CRI.

Figure 21: Typical Color Spectrum for Vero SE 29 with Décor Series

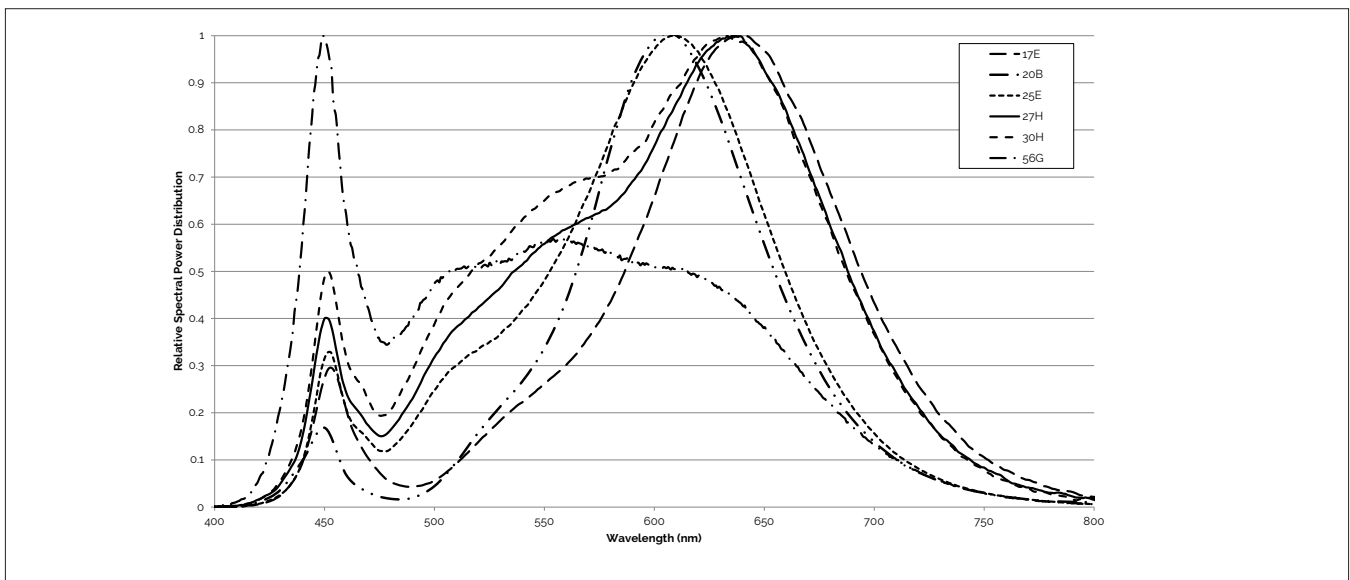

Note for Figure 21:

1. Color spectra measured at nominal current for $T_j = T_c = 25^\circ\text{C}$.

Mechanical Dimensions

Figure 22: Drawing for Vero SE 29 LED Array

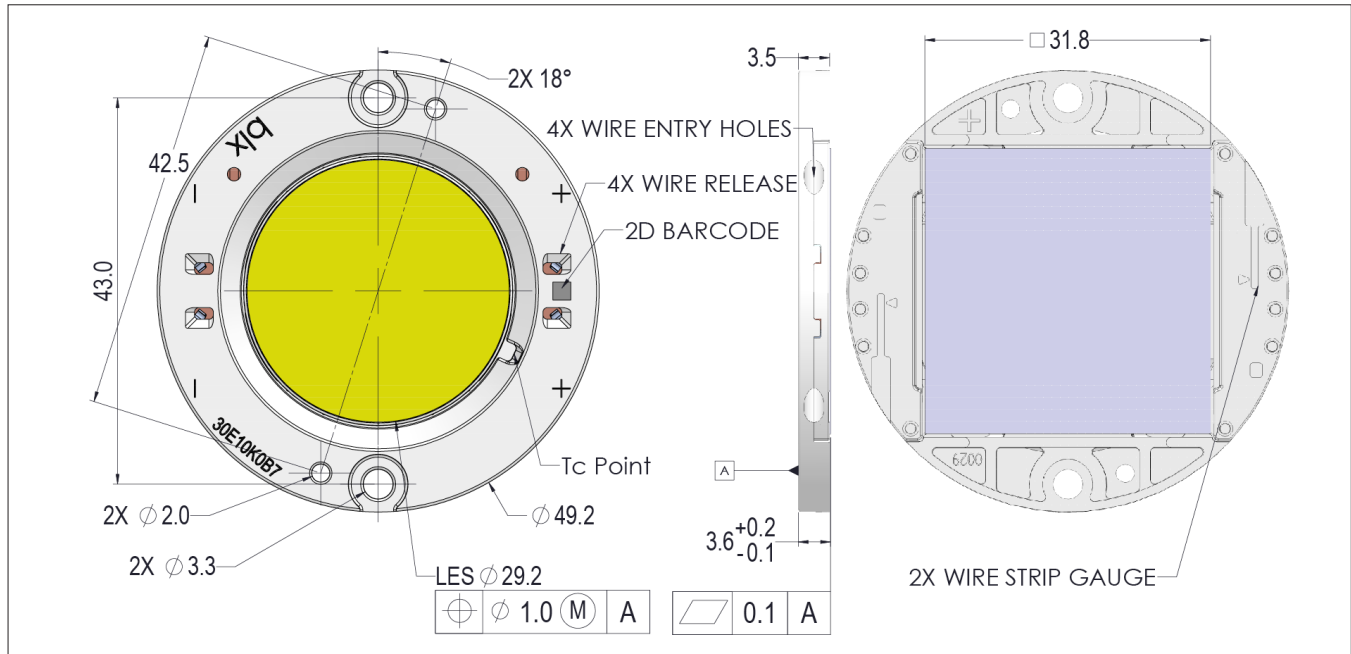

Notes for Figure 22:

1. Drawings are not to scale.
2. Drawing dimensions are in millimeters.
3. Unless otherwise specified, tolerances are $\pm 0.10\text{mm}$.
4. Mounting holes (2X) are for M3 screws.
5. Bridgelux recommends two tapped holes for mounting screws with $43.0 \pm 0.10\text{mm}$ center-to-center spacing.
6. Screws with flat shoulders (pan, dome, button, round, truss, mushroom) provide optimal torque control. Do NOT use flat, countersink, or raised head screws.
7. The optical center of the LED Array is nominally defined by the mechanical center of the array to a tolerance of $\pm 0.2\text{mm}$.
8. Bridgelux maintains a flatness of 0.10mm across the mounting surface of the array.

Color Binning Information

Figure 23: Graph of Warm and Neutral White Test Bins in xy Color Space

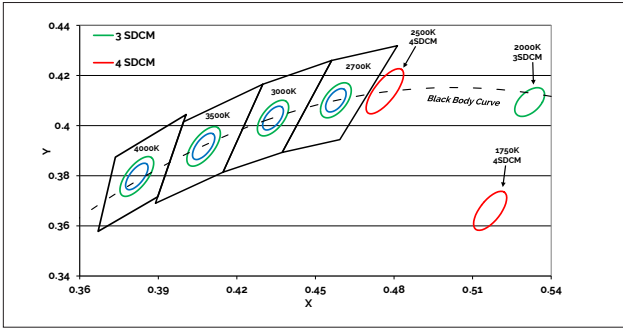

Note: Pulsed Test Conditions, $T_c = 25^\circ\text{C}$

Table 8: Warm and Neutral White xy Bin Coordinates and Associated Typical CCT

Bin Code	1750K	2500K	2700K	3000K ¹	3500K ¹	4000K ¹
ANSI Bin (for reference only)	-	-	(2580K - 2870K)	(2870K - 3220K)	(3220K - 3710K)	(3710K - 4260K)
73 (3 SDCM)	-	-	(2651K - 2794K)	(2968K - 3136K)	(3369K - 3586K)	(3851K - 4130K)
72 (2 SDCM)	-	-	(2674K - 2769K)	(2995K - 3107K)	(3404K - 3548K)	(3895K - 4081K)
Center Point (x,y)	(0.5167, 0.336)	(0.4765, 0.4137)	(0.4578, 0.4101)	(0.4338, 0.403)	(0.4073, 0.3917)	(0.3818, 0.3797)

Note for Table 8:

1. Color Binning information excludes Class A products. Please contact your Bridgelux Sales Representative for more information.

Figure 24: Graph of Cool White Test Bins in xy Color Space

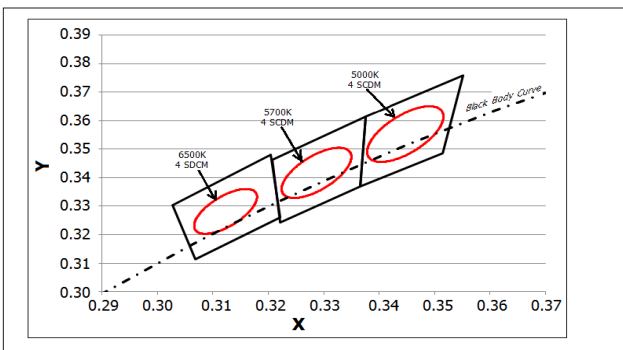

Note: Pulsed Test Conditions, $T_c = 25^\circ\text{C}$

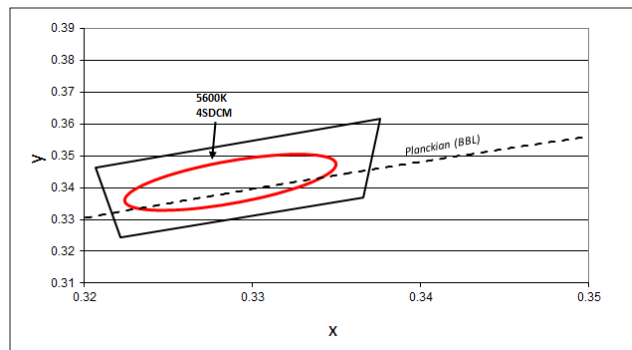

Note: Pulsed Test Conditions, $T_c = 25^\circ\text{C}$

Table 9: Cool White xy Bin Coordinates and Associated Typical CCT (product is hot targeted to $T_c = 85^\circ\text{C}$)

Bin Code	5000K	5600K ¹	5700K	6500K
ANSI Bin (for reference only)	(4745K - 5311K)	(5310K - 6020K)	(5312K - 6022K)	(6022K - 7042K)
74 (4 SDCM)	(4801K - 5282K)	(5475K - 5830K)	(5829K - 5481K)	(6270K - 6765K)
Center Point (x,y)	(0.3447, 0.3553)	(0.3293, 0.3423)	(0.3287, 0.3417)	(0.3123, 0.3282)

Note for Table 9:

1. Select configurations with a CCT of 5600K are available with center point targets at $T_c = 85^\circ\text{C}$ or $T_c = 25^\circ\text{C}$.

Packaging and Labeling

Figure 25: Drawing for Vero SE 29 Packaging Tray

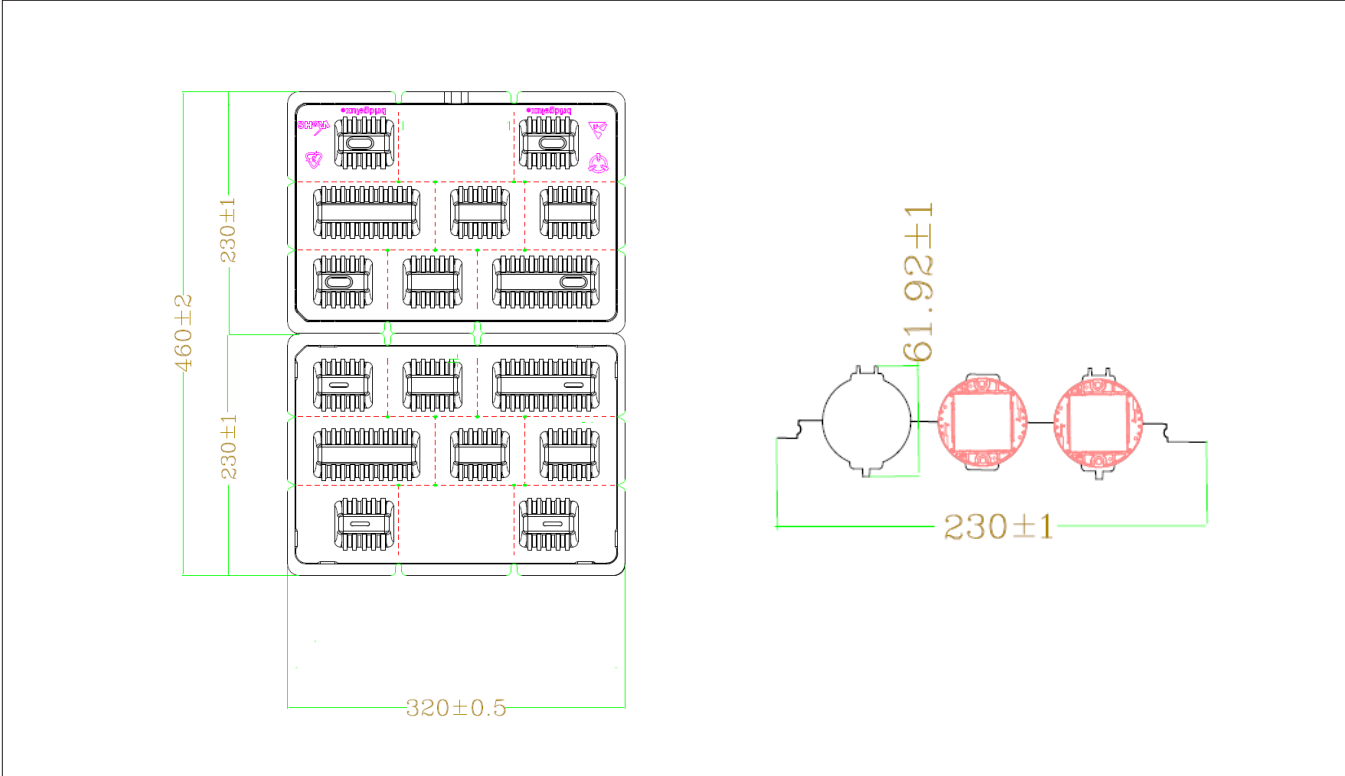

- Notes for Figure 25:
- 1. Dimensions are in millimeters.
 - 2. Drawings are not to scale.

Packaging and Labeling

Figure 26: Vero SE Series Packaging and Labeling

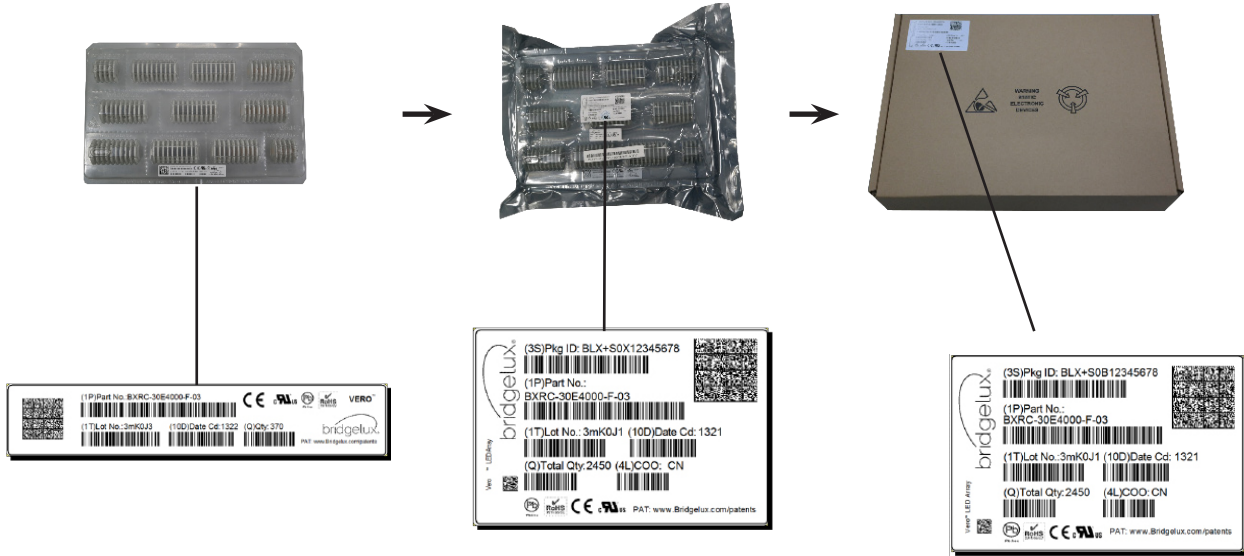

Notes for Figure 26:

1. Each tray holds 50 COBs.
2. Each tray is vacuum sealed in an anti-static bag and placed in its own box.
3. Each tray, bag and box is to be labeled as shown above.

Figure 27: Vero SE Product Labeling

Bridgelux COB arrays have laser markings on the back side of the substrate to help with product identification. In addition to the product identification markings, Bridgelux COB arrays also contain markings for internal Bridgelux manufacturing use only. The image below shows which markings are for customer use and which ones are for Bridgelux internal use only. The Bridgelux internal manufacturing markings are subject to change without notice, however these will not impact the form, function or performance of the COB array.



Customer Use- 2D Barcode
Scannable barcode provides product part number and other Bridgelux internal production information.

Customer Use- Product part number

30E10K0C 73 2F

Customer Use- V, Bin Code included to enable greater luminaire design flexibility. Refer to ANg2 for bin definitions.

Design Resources

Application Notes

Bridgelux has developed a comprehensive set of application notes and design resources to assist customers in successfully designing with the Vero product family of LED array products. For all available application notes visit www.bridgelux.com.

Optical Source Models

Optical source models and ray set files are available for all Bridgelux products. For a list of available formats, visit www.bridgelux.com.

3D CAD Models

Three dimensional CAD models depicting the product outline of all Bridgelux Vero LED arrays are available in both IGS and STEP formats. Please contact your Bridgelux sales representative for assistance.

LM80

LM80 testing has been completed and the LM80 report is now available. Please contact your Bridgelux sales representative for LM-80 report.

Precautions

CAUTION: CHEMICAL EXPOSURE HAZARD

Exposure to some chemicals commonly used in luminaire manufacturing and assembly can cause damage to the LED array. Please consult Bridgelux Application Note AN121 for additional information.

CAUTION: RISK OF BURN

Do not touch the Vero LED array during operation. Allow the array to cool for a sufficient period of time before handling. The Vero LED array may reach elevated temperatures such that could burn skin when touched.

CAUTION

CONTACT WITH LIGHT EMITTING SURFACE (LES)

Avoid any contact with the LES. Do not touch the LES of the LED array or apply stress to the LES (yellow phosphor resin area). Contact may cause damage to the LED array.

Optics and reflectors must not be mounted in contact with the LES (yellow phosphor resin area). Optical devices may be mounted on the top surface of the plastic housing of the Vero LED array. Use the mechanical features of the LED array housing, edges and/or mounting holes to locate and secure optical devices as needed.

Disclaimers

MINOR PRODUCT CHANGE POLICY

The rigorous qualification testing on products offered by Bridgelux provides performance assurance. Slight cosmetic changes that do not affect form, fit, or function may occur as Bridgelux continues product optimization.

STANDARD TEST CONDITIONS

Unless otherwise stated, array testing is performed at the nominal drive current.

About Bridgelux: We Build Light That Transforms

At Bridgelux, we help companies, industries and people experience the power and possibility of light. Since 2002, we've designed LED solutions that are high performing, energy efficient, cost effective and easy to integrate. Our focus is on light's impact on human behavior, delivering products that create better environments, experiences and returns—both experiential and financial. And our patented technology drives new platforms for commercial and industrial luminaires.

For more information about the company, please visit
bridgelux.com
twitter.com/Bridgelux
facebook.com/Bridgelux
youtube.com/user/Bridgelux
linkedin.com/company/bridgelux-inc-_2
WeChat ID: BridgeluxInChina



46430 Fremont Boulevard
Fremont, CA 94538
Tel (925) 583-8400
www.bridgelux.com

© 2016-2017 Bridgelux, Inc. All rights reserved 2016. Product specifications are subject to change without notice. Bridgelux, the Bridgelux stylized logo design and Vero are registered trademarks, and Decor Series is a trademark of Bridgelux, Inc. All other trademarks are the property of their respective owners.

Bridgelux Vero SE 29 Array Series Product Data Sheet DS123 Rev. E (3/2017)