

Bridgelux® Decor Series™

Product Data Sheet DS34



BXRC-27H1000	27H2000	27H4000	30H1000	30H2000	30H4000
BXRC-17E4000	25E4000	56G4000	17E10K0	25E10K0	56G10K0

Introduction

Vero

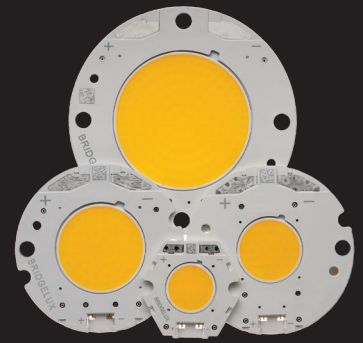

The Bridgelux Décor Series™ line of products produce unmatched quality of light with brilliant color rendering options designed specifically for high end, niche applications. The Bridgelux Décor line of specialty LED products is available on the Bridgelux Vero Series of chip on board products.

Décor Series™ Ultra products provide a high CRI of 97, befitting of the most luxurious retail shops and world renowned museums.

Décor Series™ Food products offer color points developed to address the unique requirements of the food, grocery, and restaurant industries. Highlighting the distinctive colors and nuanced patterns found in meats and breads, the Décor Food products are a must have for any butcher counter or bakery.

Décor Series™ Specialty products provide color points developed specifically for the healthcare and entertainment industries. The 5600K color point combined with a CRI of 90 provides the bright white required by these industries.

The Vero platform represents a revolutionary advancement in chip on board (COB) light source technology and innovation. Vero simplifies luminaire design and manufacturing processes, improves light quality, and defines a platform for future functionality integration.

The Vero Series products are available in four different LES (light emitting surface) configurations and have been engineered to reliably operate over a broad current range, enabling new degrees of flexibility in luminaire design optimization. These industry leading arrays deliver increased lumen density to enable improved beam control and precision lighting with 2 and 3 SDCM color control standard for clean and consistent uniform lighting. Vero also includes an on board connector port to enable solder free electrical interconnect and simple easy to use mounting features to enable plug-and-play installation.

Features

- Typical 97 CRI with a 95 CRI minimum (Décor Series Ultra)
- Application specific color points
- Typical R₉ value of 98 for brilliant rendering of red colors and skin tones (Décor Series Ultra)
- 2 and 3 SDCM color control
- Reliable operation at up to 2X nominal drive current
- Radial die pattern and improved lumen density
- Thermally isolated solder pads
- Onboard connector port
- Top side part number markings

Benefits

- Broad application coverage for interior lighting requiring state of the art color rendering
- Flexibility for application driven lighting design requirements
- High quality true color reproduction
- Uniform consistent white light
- Flexibility in design optimization
- Improved optical control
- Enhanced ease of use and manufacturability
- Solder-less connectivity enables plug & play installation and field upgradability
- Improved inventory management and quality control



Contents

Product Feature Map	2
Product Nomenclature	2
Product Selection Guide	3
Performance at Commonly Used Drive Currents	4
Electrical Characteristics	6
Absolute Maximum Ratings	7
Performance Curves	8
Typical Radiation Pattern	15
Typical Color Spectrum	16
Mechanical Dimensions	17
Color Binning Information	21
Packaging and Labeling	22
Design Resources	25
Precautions	25
Disclaimers	25
About Bridgelux	26

Product Feature Map

In addition to delivering the performance and light quality required for many lighting applications, Décor Series LED arrays incorporate several features to

simplify the design integration and manufacturing process, accelerate time to market and reduce system costs.

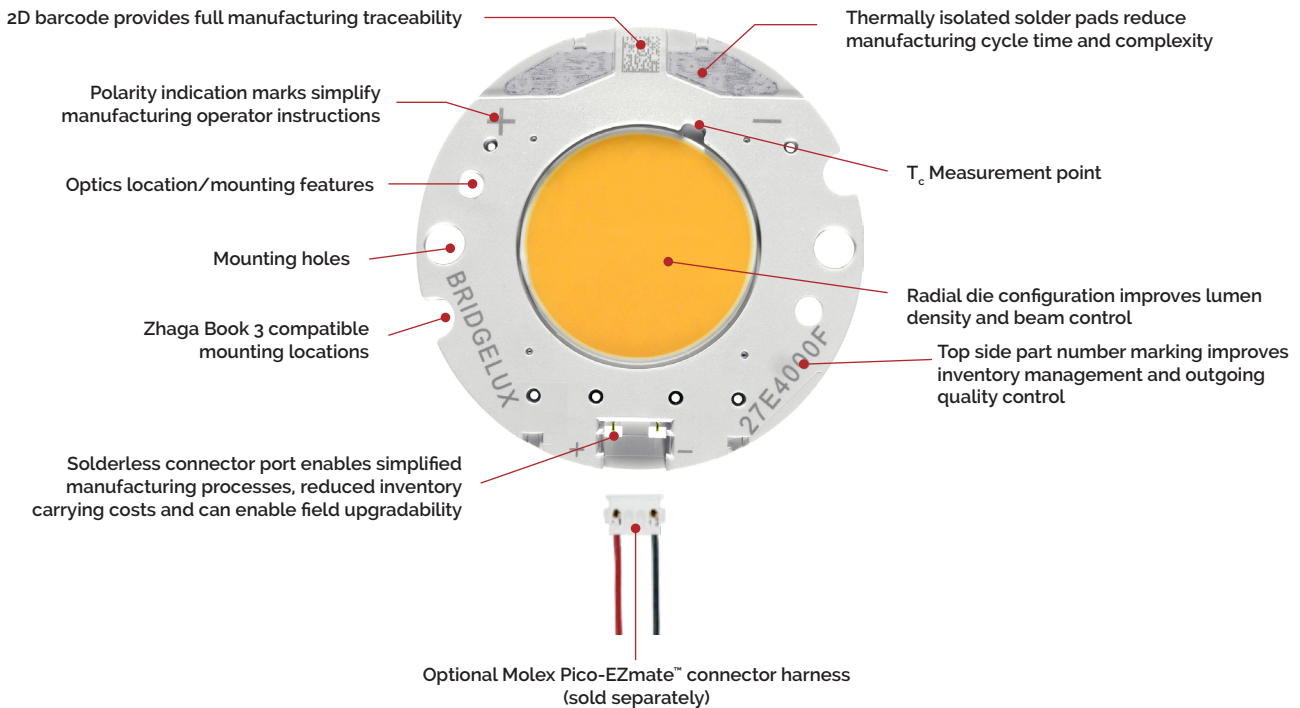

Product Nomenclature

The part number designation for Bridgelux Vero Décor Series LED arrays is explained as follows:

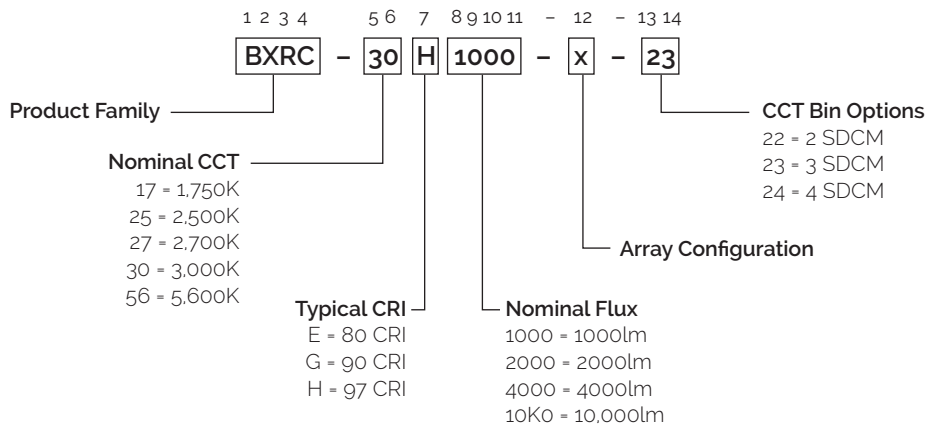

Product Selection Guide

The following product configurations are available:

Table 1: Selection Guide, Pulsed Measurement Data ($T_j = T_c = 25^\circ\text{C}$)

Product	Part Number	Nominal CCT ¹ (K)	CRI ²	Nominal Drive Current ³ (mA)	Typical Pulsed Flux ^{4,5,6} $T_c = 25^\circ\text{C}$ (lm)	Minimum Pulsed Flux ^{6,7} $T_c = 25^\circ\text{C}$ (lm)	Typical V_f (V)	Typical Power (W)	Typical Efficacy (lm/W)
Décor Ultra Vero 10	BXRC-27H1000-B-2x	2700	97	350	766	698	26.5	9.3	83
Décor Ultra Vero 10	BXRC-30H1000-B-2x	3000	97	350	799	731	26.5	9.3	86
Décor Ultra Vero 13	BXRC-27H2000-C-2x	2700	97	500	1331	1232	32.3	16.2	82
Décor Ultra Vero 13	BXRC-30H2000-C-2x	3000	97	500	1435	1304	32.3	16.2	89
Décor Ultra Vero 18	BXRC-27H4000-F-2x	2700	97	1050	2534	2368	29.5	31.0	82
Décor Ultra Vero 18	BXRC-30H4000-F-2x	3000	97	1050	2724	2519	29.5	31.0	88
Décor Food Vero 18	BXRC-17E4000-F-24	1750	80	1050	2254	2100	29.5	31.0	73
Décor Food Vero 18	BXRC-25E4000-F-24	2500	80	1050	3651	3283	29.5	31.0	118
Décor Specialty Vero 18	BXRC-56G4000-F-24	5600	90	1050	3888	3421	29.5	31.0	126
Décor Food Vero 29	BXRC-17E10K0-L-24	1750	80	2100	5406	4930	38.0	79.8	68
Décor Food Vero 29	BXRC-25E10K0-L-24	2500	80	2100	9298	8706	38.0	79.8	117
Décor Specialty Vero 29	BXRC-56G10K0-L-24	5600	90	2100	9948	8903	38.0	79.8	125

Table 2: Selection Guide, Stabilized DC Performance ($T_c = 85^\circ\text{C}$)^{8,9}

Product	Part Number	Nominal CCT ¹ (K)	CRI ²	Nominal Drive Current ³ (mA)	Typical DC Flux $T_c = 85^\circ\text{C}$ (lm)	Minimum DC Flux ¹⁰ $T_c = 85^\circ\text{C}$ (lm)	Typical V_f (V)	Typical Power (W)	Typical Efficacy (lm/W)
Décor Ultra Vero 10	BXRC-27H1000-B-2x	2700	97	350	632	576	25.8	9.0	70
Décor Ultra Vero 10	BXRC-30H1000-B-2x	3000	97	350	669	612	25.8	9.0	74
Décor Ultra Vero 13	BXRC-27H2000-C-2x	2700	97	500	1105	1023	31.5	15.7	70
Décor Ultra Vero 13	BXRC-30H2000-C-2x	3000	97	500	1189	1080	31.5	15.7	76
Décor Ultra Vero 18	BXRC-27H4000-F-2x	2700	97	1050	2093	1956	28.8	30.2	69
Décor Ultra Vero 18	BXRC-30H4000-F-2x	3000	97	1050	2288	2116	28.8	30.2	76
Décor Food Vero 18	BXRC-17E4000-F-24	1750	80	1050	2004	1867	28.8	30.2	66
Décor Food Vero 18	BXRC-25E4000-F-24	2500	80	1050	3242	2915	28.8	30.2	107
Décor Specialty Vero 18	BXRC-56G4000-F-24	5600	90	1050	3407	2998	28.8	30.2	113
Décor Food Vero 29	BXRC-17E10K0-L-24	1750	80	2100	4803	4381	36.8	77.3	62
Décor Food Vero 29	BXRC-25E10K0-L-24	2500	80	2100	8047	7535	36.8	77.3	104
Décor Specialty Vero 29	BXRC-56G10K0-L-24	5600	90	2100	8830	7903	36.8	77.3	114

Notes for Tables 1 & 2:

- Nominal CCT as defined by ANSI C78.377-2011.
- Minimum CRI for 97 CRI products is 95 CRI, all other CRI values are minimums. Minimum Rg value for 80 CRI products is 0, the minimum Rg values for 90 CRI products is 50.
- Drive current is referred to as nominal drive current.
- Products tested under pulsed condition (10ms pulse width) at nominal test current where T_j (junction temperature) = T_c (case temperature) = 25°C .
- Typical performance values are provided as a reference only and are not a guarantee of performance.
- Bridgelux maintains a $\pm 7\%$ tolerance on flux measurements.
- Minimum flux values at the nominal test current are guaranteed by 100% test.
- Typical stabilized DC performance values are provided as reference only and are not a guarantee of performance.
- Typical performance is estimated based on operation under DC (direct current) with LED array mounted onto a heat sink with thermal interface material and the case temperature maintained at 85°C . Based on Bridgelux test setup, values may vary depending on the thermal design of the luminaire and/or the exposed environment to which the product is subjected.
- Minimum flux values at elevated temperatures are provided for reference only and are not guaranteed by 100% production testing. Based on Bridgelux test setup, values may vary depending on the thermal design of the luminaire and/or the exposed environment to which the product is subjected.

Performance at Commonly Used Drive Currents

Vero LED arrays are tested to the specifications shown using the nominal drive currents in Table 1. Vero may also be driven at other drive currents dependent on specific application design requirements. The performance at any drive current can be derived from the current vs. voltage characteristics shown in Figure 3-6 and the flux vs. current characteristics shown in Figures 7-10. The performance at commonly used drive currents is summarized in Table 3.

Table 3: Product Performance at Commonly Used Drive Currents

Product	Part Number	CRI	Drive Current ¹ (mA)	Typical V_f $T_c = 25^\circ\text{C}$ (V)	Typical Power $T_j = 25^\circ\text{C}$ (W)	Typical Flux ² $T_c = 25^\circ\text{C}$ (lm)	Typical DC Flux ³ $T_c = 85^\circ\text{C}$ (lm)	Typical Efficacy $T_j = 25^\circ\text{C}$ (lm/W)
Décor Ultra Vero 10	BXRC-27H1000-B-2x	97	175	25.3	4.4	406	335	92
			350	26.5	9.3	766	632	83
			500	27.4	13.7	1039	858	76
			700	28.4	19.9	1354	1118	68
Décor Ultra Vero 10	BXRC-30H1000-B-2x	97	175	25.3	4.4	423	355	96
			350	26.5	9.3	799	669	86
			500	27.4	13.7	1084	908	79
			700	28.4	19.9	1412	1183	71
Décor Ultra Vero 13	BXRC-27H2000-C-2x	97	175	30.2	5.3	503	417	95
			350	31.4	11.0	964	801	88
			500	32.3	16.2	1331	1105	82
			700	33.4	23.4	1783	1481	76
			1050	35.1	36.9	2464	2046	67
Décor Ultra Vero 13	BXRC-30H2000-C-2x	97	175	30.2	5.3	542	449	103
			350	31.4	11.0	1039	861	95
			500	32.3	16.2	1435	1189	89
			700	33.4	23.4	1923	1593	82
			1050	35.1	36.9	2657	2202	72
Décor Ultra Vero 18	BXRC-27H4000-F-2x	97	500	28.1	14.1	1282	1059	91
			700	28.7	20.1	1751	1446	87
			1050	29.5	31.0	2534	2093	82
			1400	30.2	42.3	3249	2684	77
			2100	31.6	66.4	4530	3741	68
Décor Ultra Vero 18	BXRC-30H4000-F-2x	97	500	28.1	14.1	1379	1158	98
			700	28.7	20.1	1882	1581	94
			1050	29.5	31.0	2724	2288	88
			1400	30.2	42.3	3493	2934	83
			2100	31.6	66.4	4869	4089	73

Notes for Table 3:

1. Alternate drive currents in Table 3 are provided for reference only and are not a guarantee of performance.
2. Bridgelux maintains a $\pm 7\%$ tolerance on flux measurements.
3. Typical stabilized DC performance values are provided as reference only and are not a guarantee of performance.

Performance at Commonly Used Drive Currents

Table 3: Product Performance at Commonly Used Drive Currents (continued)

Product	Part Number	CRI	Drive Current ¹ (mA)	Typical V_f $T_c = 25^\circ\text{C}$ (V)	Typical Power $T_j = 25^\circ\text{C}$ (W)	Typical Flux ² $T_c = 25^\circ\text{C}$ (lm)	Typical DC Flux ³ $T_c = 85^\circ\text{C}$ (lm)	Typical Efficacy $T_j = 25^\circ\text{C}$ (lm/W)
Décor Food Vero 18	BXRC-17E4000-F-24	80	500	28.1	14.1	1141	1014	81
			700	28.7	20.1	1557	1384	78
			1050	29.5	31.0	2254	2004	73
			1400	30.2	42.3	2890	2569	68
			2100	31.6	66.4	4029	3581	61
Décor Food Vero 18	BXRC-25E4000-F-24	80	500	28.1	14.1	1848	1641	132
			700	28.7	20.1	2522	2240	126
			1050	29.5	31.0	3651	3242	118
			1400	30.2	42.3	4682	4157	111
			2100	31.6	66.4	6526	5796	98
Décor Specialty Vero 18	BXRC-56G4000-F-24	90	500	28.1	14.1	1968	1725	140
			700	28.7	20.1	2686	2354	134
			1050	29.5	31.0	3888	3407	126
			1400	30.2	42.3	4985	4369	118
			2100	31.6	66.4	6950	6091	105
Décor Food Vero 29	BXRC-17E10K0-L-24	80	500	35.1	17.6	1450	1289	82
			700	35.6	24.9	1982	1761	80
			1050	36.4	38.2	2887	2565	76
			2100	38	79.8	5406	4803	68
			2800	39	109.2	6936	6163	64
			3150	39.5	124.4	7650	6797	61
			4200	40.4	169.7	9601	8531	57
Décor Food Vero 29	BXRC-25E10K0-L-24	80	500	35.1	17.6	2494	2159	142
			700	35.6	24.9	3409	2950	137
			1050	36.4	38.2	4966	4298	130
			2100	38	79.8	9298	8047	117
			2800	39	109.2	11929	10325	109
			3150	39.5	124.4	13157	11388	106
			4200	40.4	169.7	16513	14292	97
Décor Specialty Vero 29	BXRC-56G10K0-L-24	90	500	35.1	17.6	2669	2369	152
			700	35.6	24.9	3647	3237	146
			1050	36.4	38.2	5313	4716	139
			2100	38	79.8	9948	8830	125
			2800	39	109.2	12763	11329	117
			3150	39.5	124.4	14077	12495	113
			4200	40.4	169.7	17668	15682	104

Notes for Table 3:

1. Alternate drive currents in Table 3 are provided for reference only and are not a guarantee of performance.
2. Bridgelux maintains a $\pm 7\%$ tolerance on flux measurements.
3. Typical stabilized DC performance values are provided as reference only and are not a guarantee of performance.

Electrical Characteristics

Table 4: Electrical Characteristics

Part Number	Nominal Drive Current ¹ (mA)	Forward Voltage Pulsed, T _c = 25°C (V) ^{1, 2, 3}			Typical Coefficient of Forward Voltage ⁴ $\Delta V_f / \Delta T_c$ (mV/°C)	Typical Thermal Resistance Junction to Case ^{5, 6} R _{j-c} (C/W)	Driver Selection Voltages ⁷ (V)	
		Minimum	Typical	Maximum			V _f Min. Hot T _c = 105°C (V)	V _f Max. Cold ⁴ T _c = -40°C (V)
BXRC-xxx1000-B-2x	350	24.5	26.5	28.5	-14	0.47	23.4	29.4
	700	26.5	29.0	31.2	-14	0.59	25.4	32.1
BXRC-xxx2000-C-2x	500	29.9	32.3	34.7	-17	0.22	28.5	35.8
	1050	32.0	35.1	37.9	-17	0.28	30.6	39.0
BXRC-xxx4000-F-2x	1050	27.3	29.5	31.7	-15	0.13	26.1	32.7
	2100	29.2	31.6	34.2	-15	0.17	28.0	35.2
BXRC-xxx10K0-L-2x	2100	35.2	38.0	40.9	-20	0.06	33.6	42.2
	4200	37.3	40.4	44.0	-20	0.07	35.7	45.3

Notes for Table 4:

1. Parts are tested in pulsed conditions, T_c = 25°C. Pulse width is 10ms.
2. Voltage minimum and maximum are provided for reference only and are not a guarantee of performance.
3. Bridgelux maintains a tester tolerance of ± 0.10V on forward voltage measurements.
4. Typical coefficient of forward voltage tolerance is ± 0.1mV for nominal current.
5. Thermal resistance values are based from test data of a 3000K 80 CRI product.
6. Thermal resistance value was calculated using total electrical input power; optical power was not subtracted from input power. The thermal interface material used during testing is not included in the thermal resistance value.
7. V_f min hot and max cold values are provided as reference only and are not guaranteed by test. These values are provided to aid in driver design and selection over the operating range of the product.

Absolute Maximum Ratings

Table 5: Maximum Ratings

Parameter	Maximum Rating			
LED Junction Temperature	150°C			
Storage Temperature	-40°C to +105°C			
Operating Case Temperature ^{1,2}	105°C			
Soldering Temperature ³	350°C or lower for a maximum of 10 seconds			
	BXRC-xxx1000-B-2x	BXRC-xxx2000-C-2x	BXRC-xxx4000-F-2x	BXRC-xxx10K0-L-2x
Maximum Drive Current ¹	700 mA	1050 mA	2100 mA	4200 mA
Maximum Peak Pulsed Drive Current ⁴	1500 mA	1500 mA	3000 mA	6000 mA
Maximum Reverse Voltage ⁵	-45V	-55 V	-55 V	-65 V

Notes for Table 5:

1. Please refer to Figures 1 and 2 for drive current derating curve for Vero 10 and Vero 29. Vero 13 and Vero 18 may be driven at 2 times nominal current upto 105°C.
2. For IEC 62717 requirement, please contact Bridgelux Sales Support.
3. See Bridgelux Application Note AN31, Assembly Considerations for Vero LED arrays, for more information.
4. Bridgelux recommends a maximum duty cycle of 10% and pulse width of 20ms when operating LED Arrays at the maximum peak pulsed current specified. Maximum peak pulsed current indicate values where the LED array can be driven without catastrophic failures.
5. Light emitting diodes are not designed to be driven in reverse voltage and will not produce light under this condition. Maximum rating provided for reference only.

Performance Curves

The maximum allowable drive current for the Vero 10 and Vero 29 product families is dependent on the operating case temperature. Please refer to the Product Feature Map (page 2) for the location of the T_c Point.

Figure 1: Vero 10 Drive Current Derating Curve

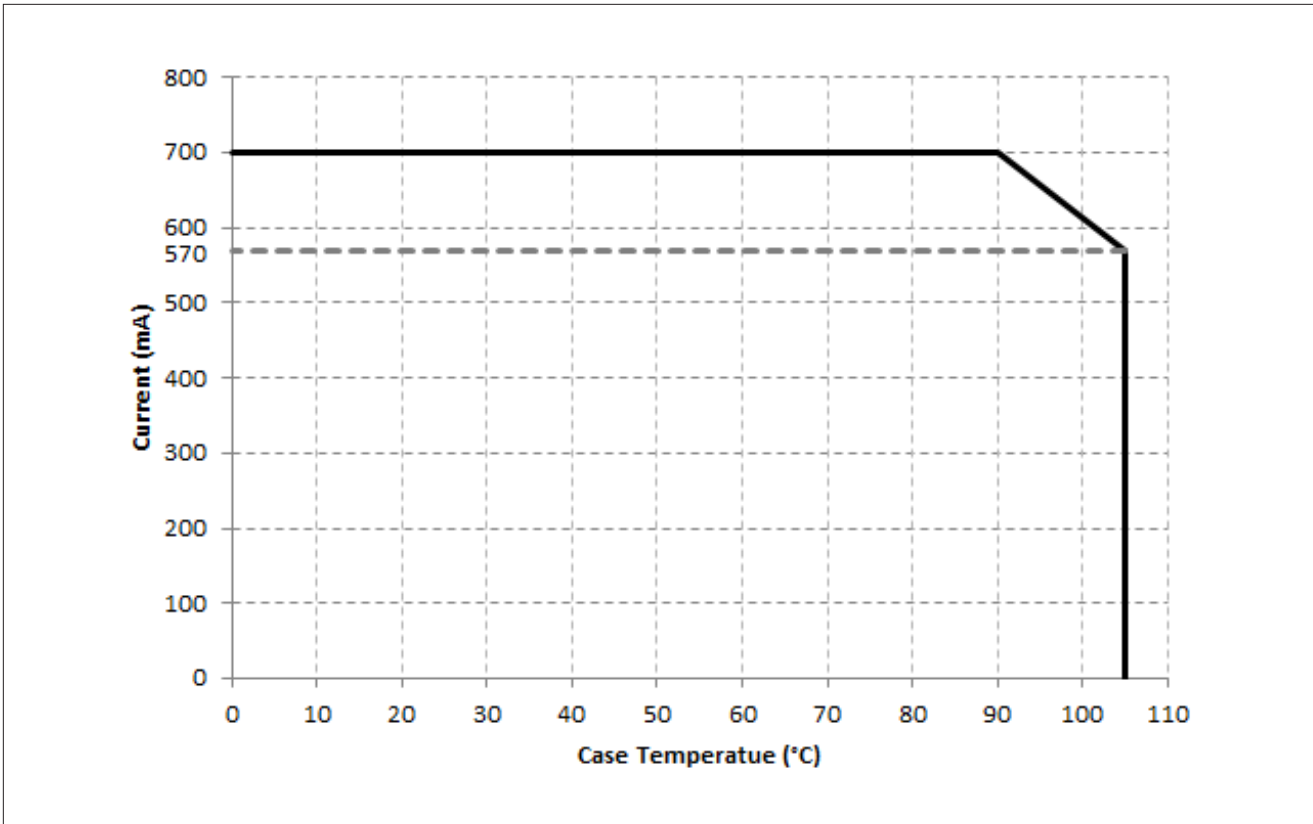

Notes for Figure 1:

1. In order to meet LM-80 lifetime projections Vero 10 may be driven up to 700mA at case temperatures up to 90°C. Operating conditions above case temperatures of 90°C driving conditions must follow the Vero 10 Drive Current Derating Curve.
2. Lumen maintenance (L70) and lifetime predictions are valid for drive current and case temperature conditions used for LM-80 testing as included in the applicable LM-80 test report for these products. Contact your Bridgelux sales representative for LM-80 report.

Performance Curves

Figure 2: Vero 29 Drive Current Derating Curve

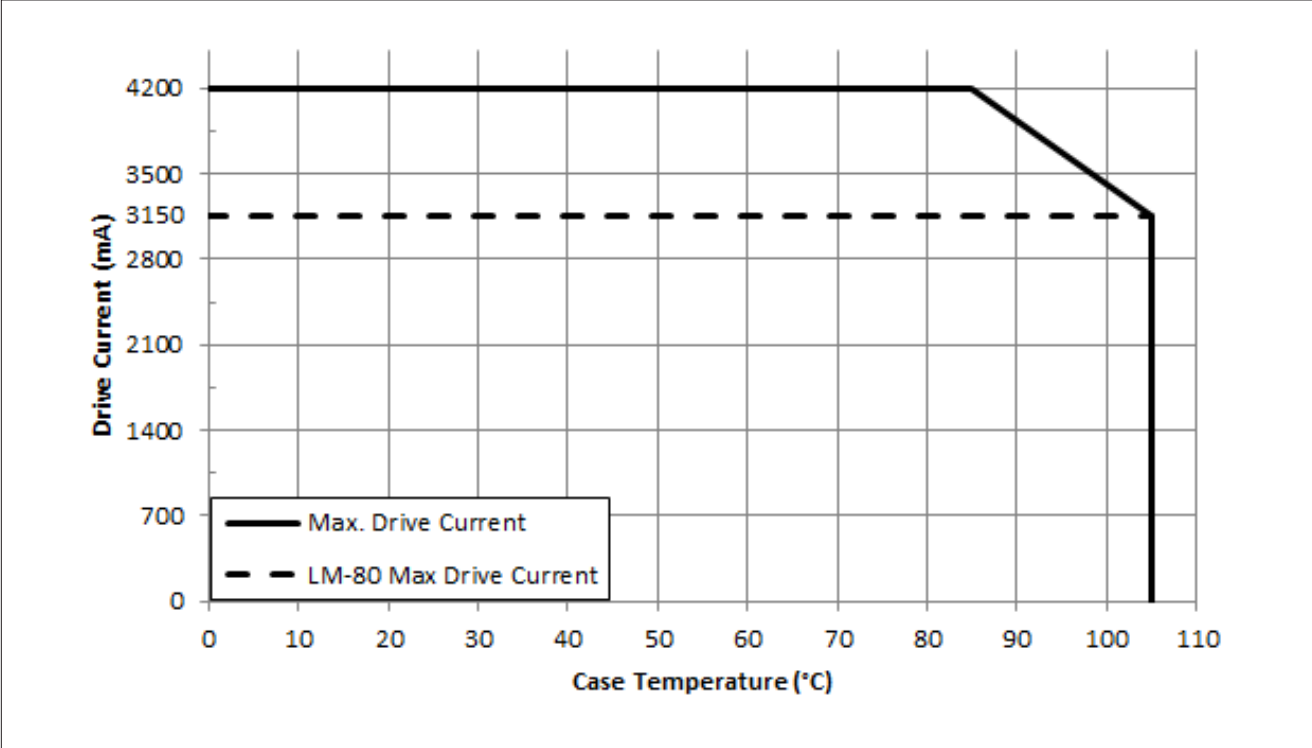

Notes for Figure 2:

- 1. LM-80 Max Drive Current must not be exceeded in order to meet LM-80 lifetime projections.
- 2. Lumen maintenance (L70) and lifetime predictions are valid for drive current and case temperature conditions used for LM-80 testing as included in the applicable LM-80 test report for these products. Contact your Bridgelux sales representative for LM-80 report.

Performance Curves

Figure 3: Vero 10 Drive Current vs. Forward Voltage
($T_j=T_c=25^\circ\text{C}$)

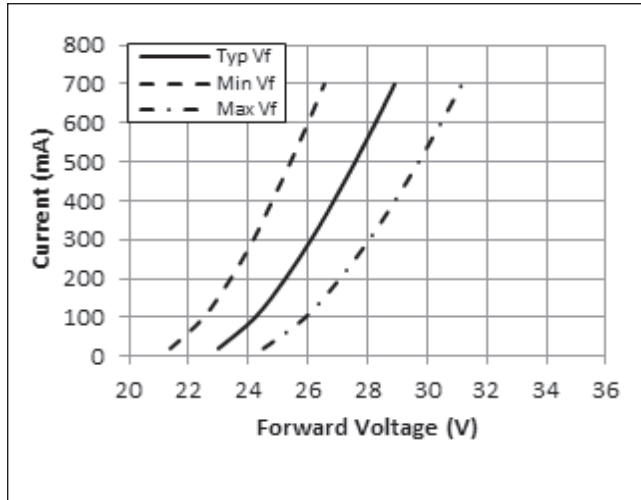

Figure 4: Vero 13 Drive Current vs. Forward Voltage
($T_j=T_c=25^\circ\text{C}$)

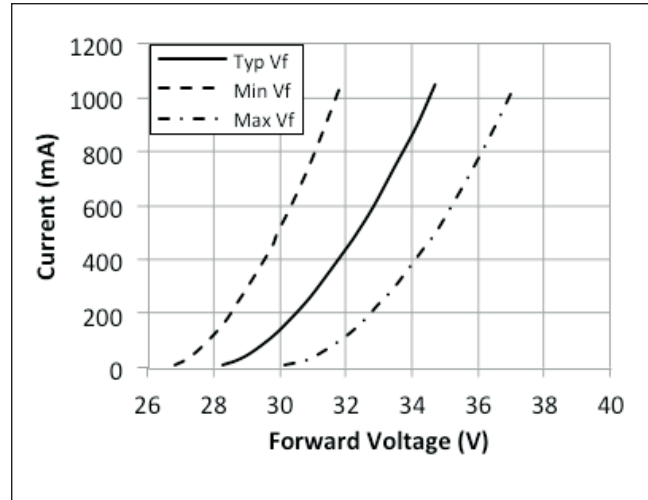

Figure 5: Vero 18 Drive Current vs. Forward Voltage
($T_j=T_c=25^\circ\text{C}$)

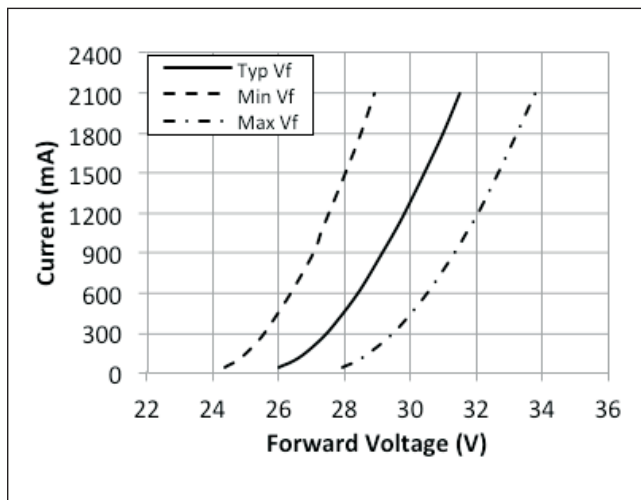
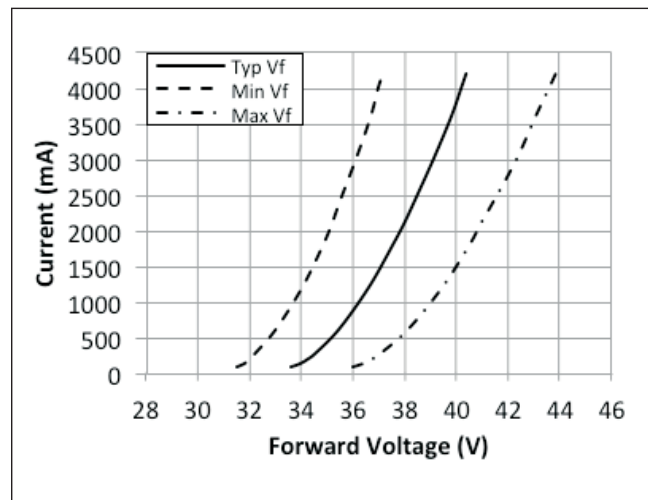

Figure 6: Vero 29 Drive Current vs. Forward Voltage
($T_j=T_c=25^\circ\text{C}$)



Performance Curves

Figure 7: Vero 10 Typical Relative Luminous Flux vs. Drive Current

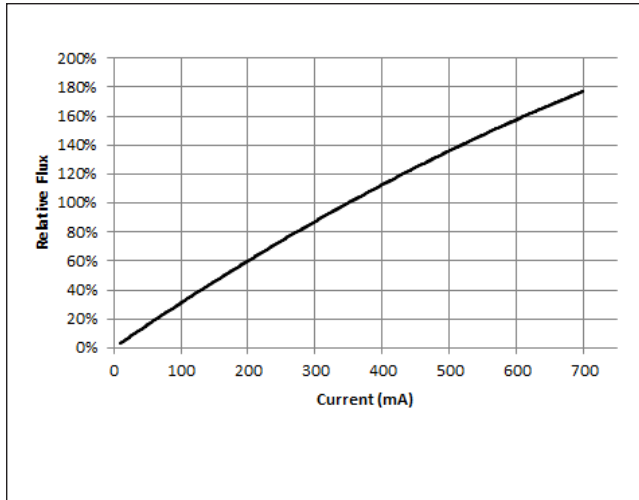

Figure 8: Vero 13 Typical Relative Luminous Flux vs. Drive Current

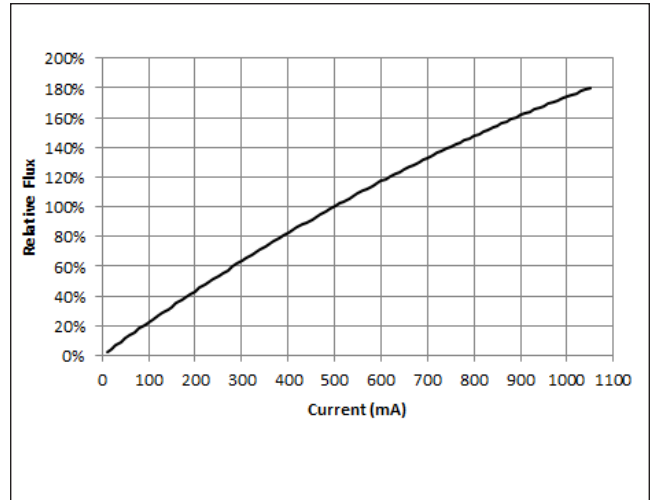

Figure 9: Vero 18 Typical Relative Luminous Flux vs. Drive Current

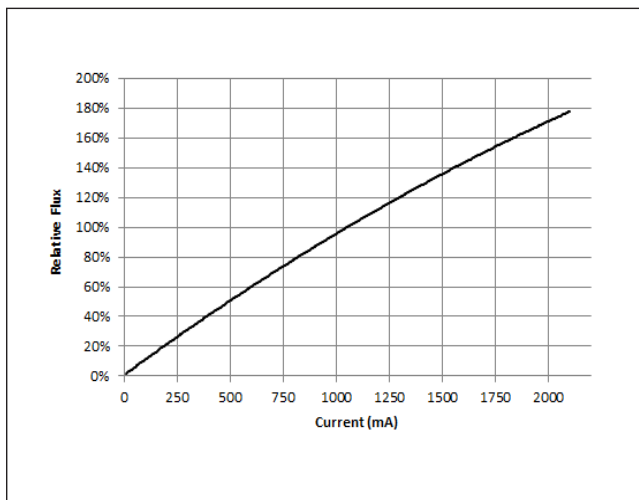
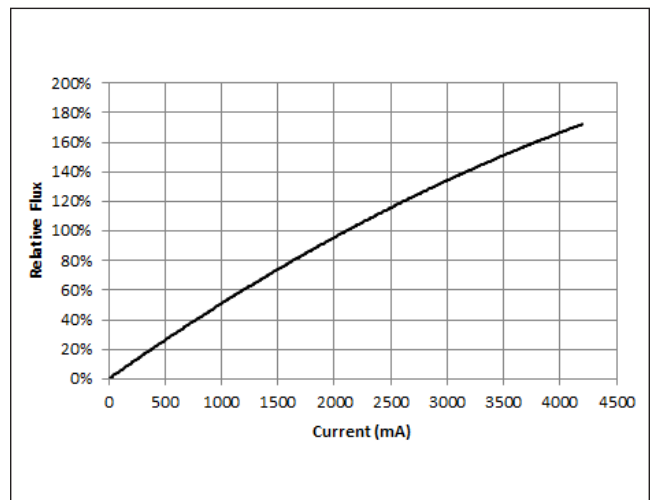

Figure 10: Vero 29 Typical Relative Luminous Flux vs. Drive Current



Performance Curves

Figure 11: Vero 10 Typical DC Flux vs. Case Temperature

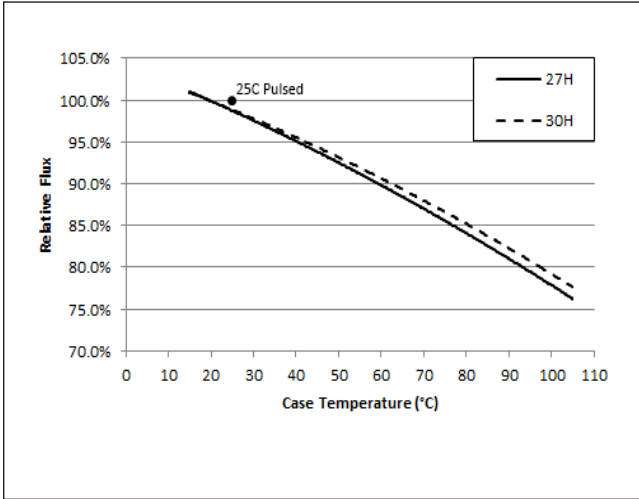

Figure 12: Vero 13 Typical DC Flux vs. Case Temperature

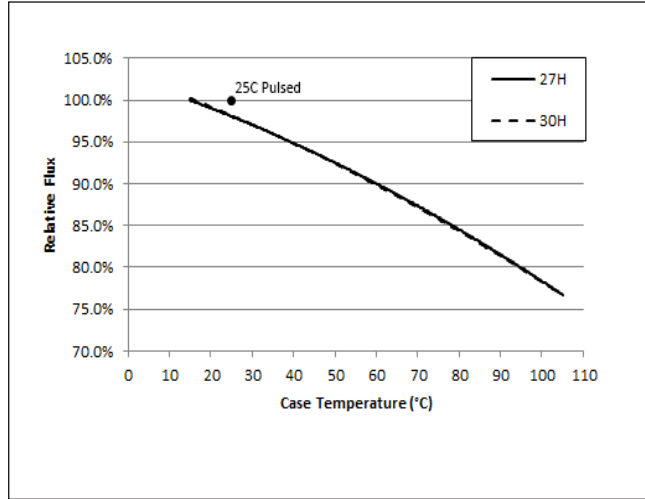

Figure 13: Vero 18 Typical DC Flux vs. Case Temperature

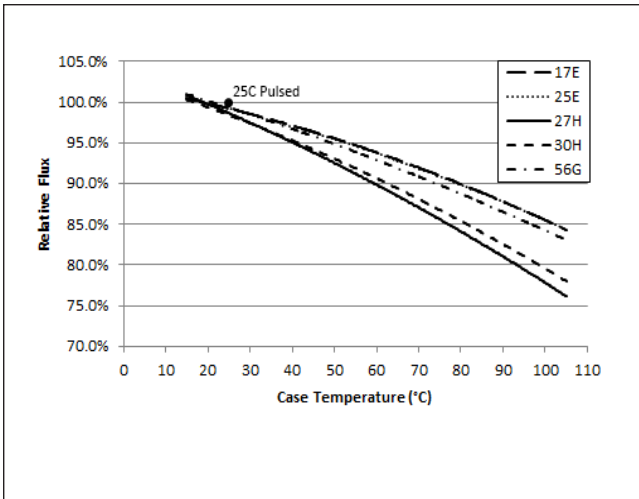
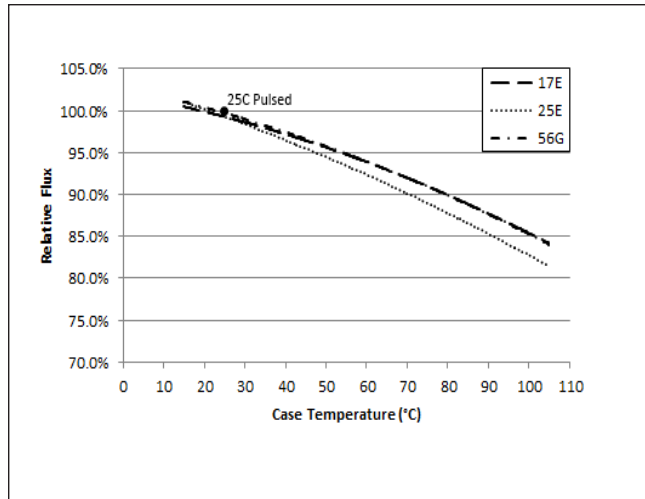

Figure 14: Vero 29 Typical DC Flux vs. Case Temperature



Performance Curves

Figure 15: 1750K Color Shift vs. Case Temperature¹

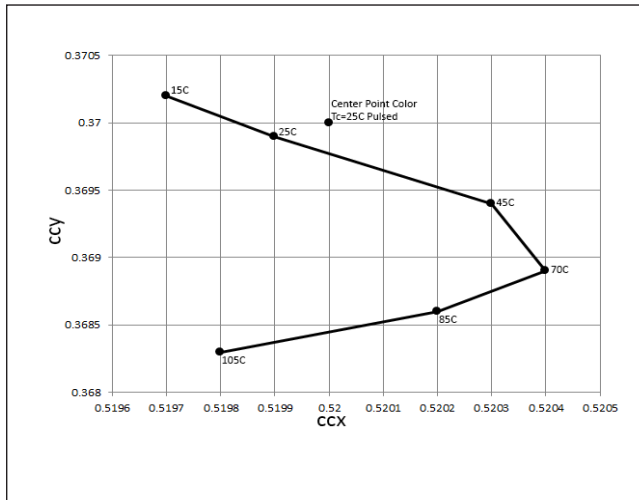

Figure 16: 2500K Color Shift vs. Case Temperature¹

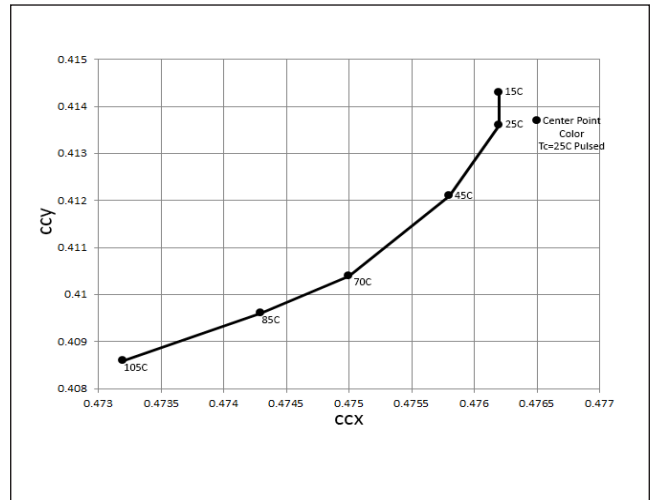

Figure 17: 2700K Color Shift vs. Case Temperature¹

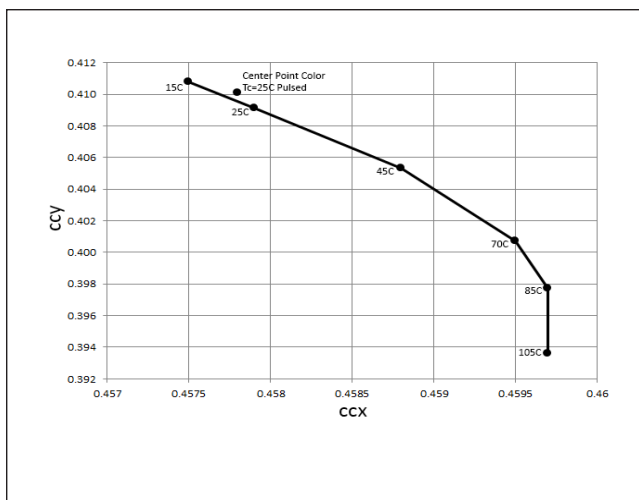
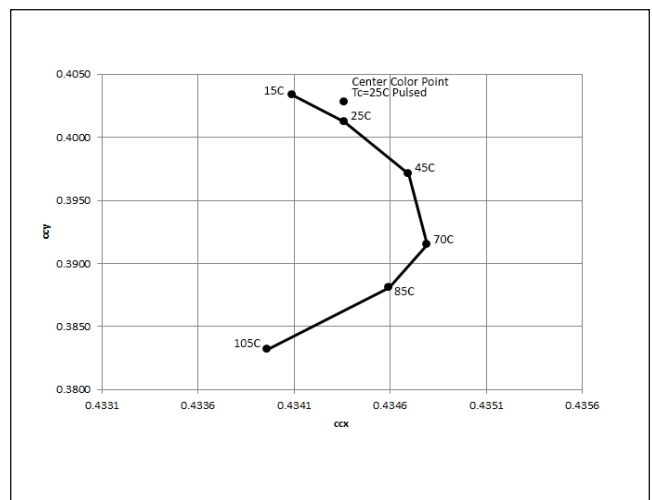

Figure 18: 3000K Color Shift vs. Case Temperature¹



Note for Figures 15-18:

1. Measurements made under DC test conditions at the nominal drive current.
2. Typical color shift is shown with a tolerance of ± 0.002 .

Performance Curves

Figure 19: 5600K Color Shift vs. Case Temperature¹

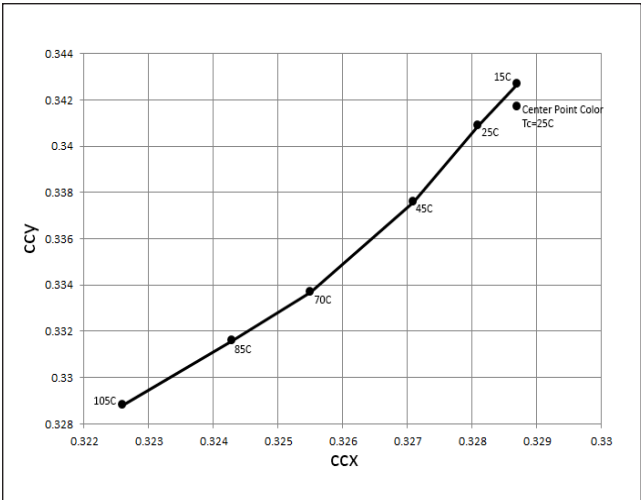

Note for Figures 19:

- 1. Measurements made under DC test conditions at the nominal drive current.
- 2. Typical color shift is shown with a tolerance of ± 0.002 .

Typical Radiation Pattern

Figure 20: Typical Spatial Radiation Pattern

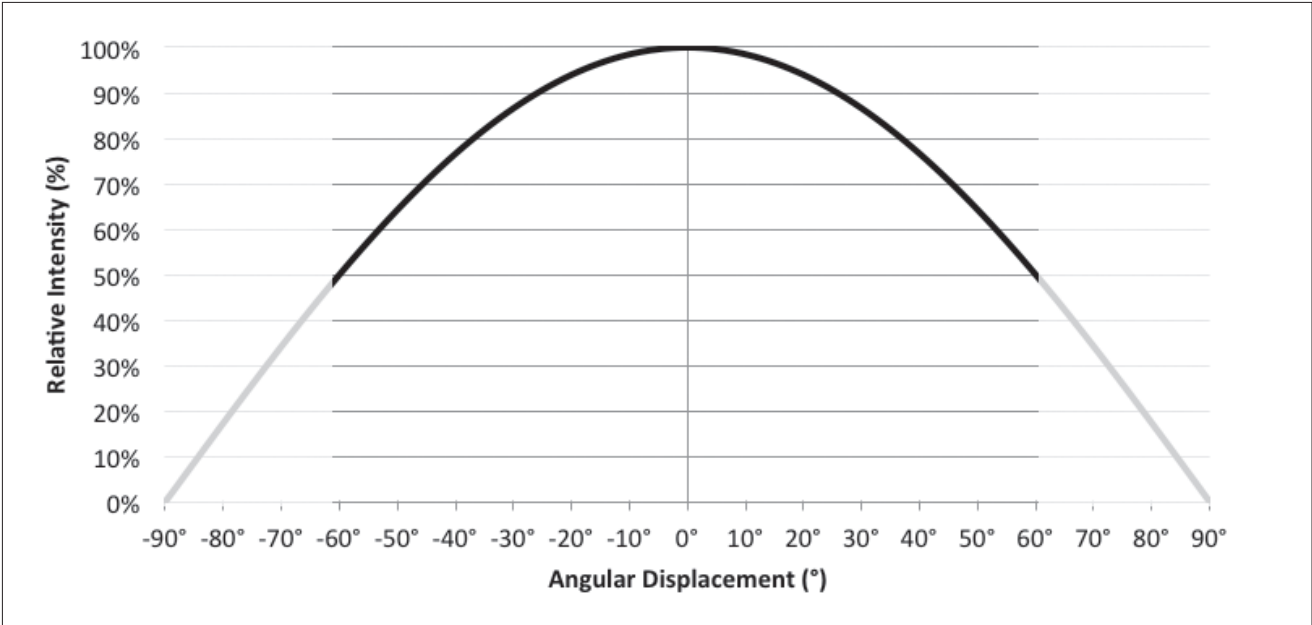

Notes for Figure 20:

- 1. Typical viewing angle is 120°.
- 2. The viewing angle is defined as the off axis angle from the centerline where I_v is $\frac{1}{2}$ of the peak value.

Figure 21: Typical Polar Radiation Pattern

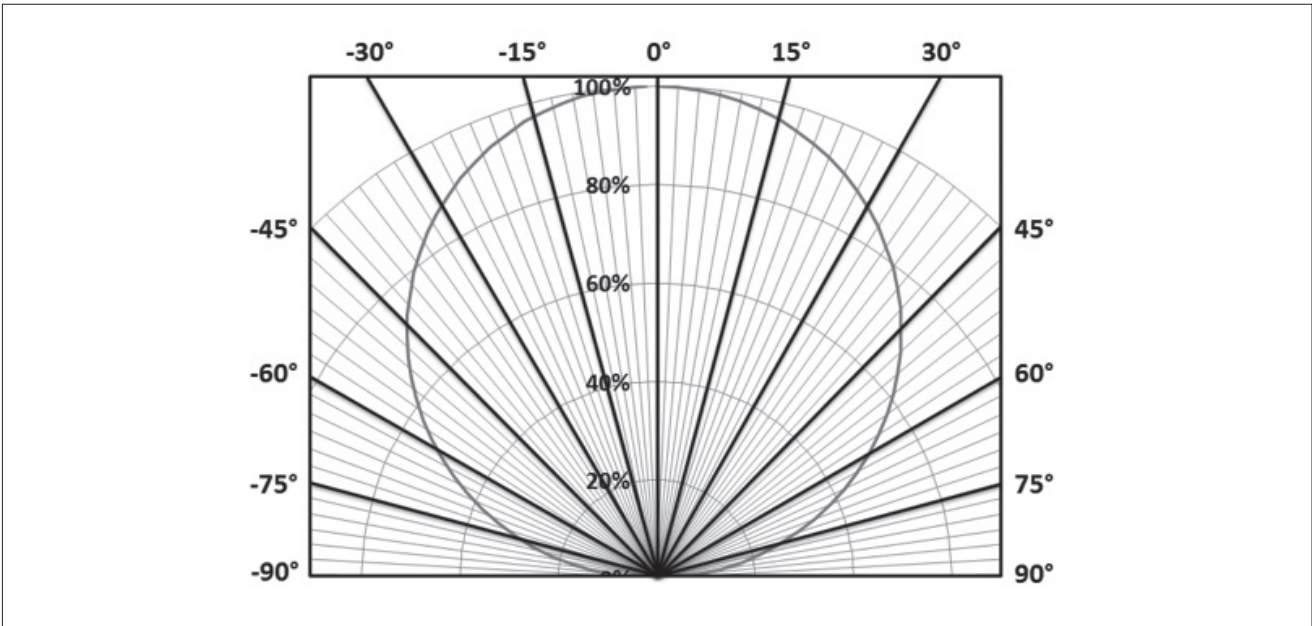

Typical Color Spectrum

97 CRI- Wavelength & CRI Characteristics at Drive Current, Tc=25°C

The high CRI light delivered by the Bridgelux Vero Décor products reproduces colors faithfully compared with natural light. Figure 22 displays the spectral curve of Décor.

Table 6 compares CRI R values of Décor to other light sources. The typical overall CRI (Ra) of 97 results in excellent color representation - especially for colors which the human eye is particularly sensitive.

Décor delivers high typical values of R9 (98) and R15 (98). These are important attributes for the perception of realistic colors. R9 enhances red colors and R15 enables realistic rendering of human skin tones.

Figure 22: Typical Color Spectrum

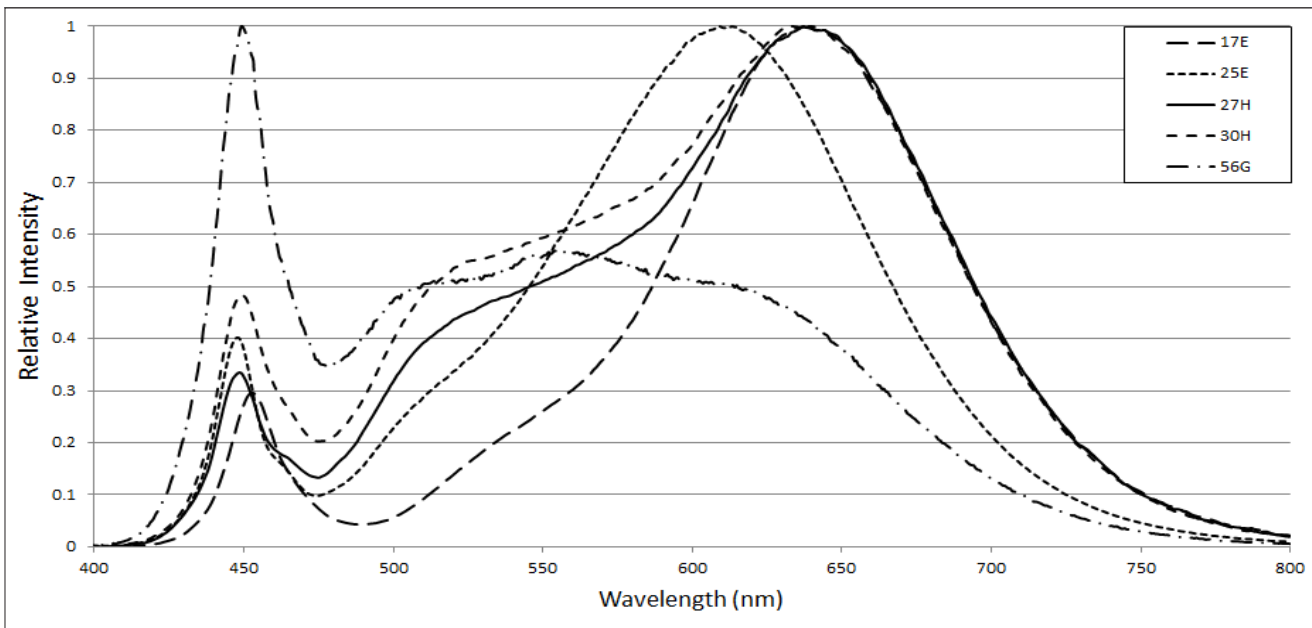
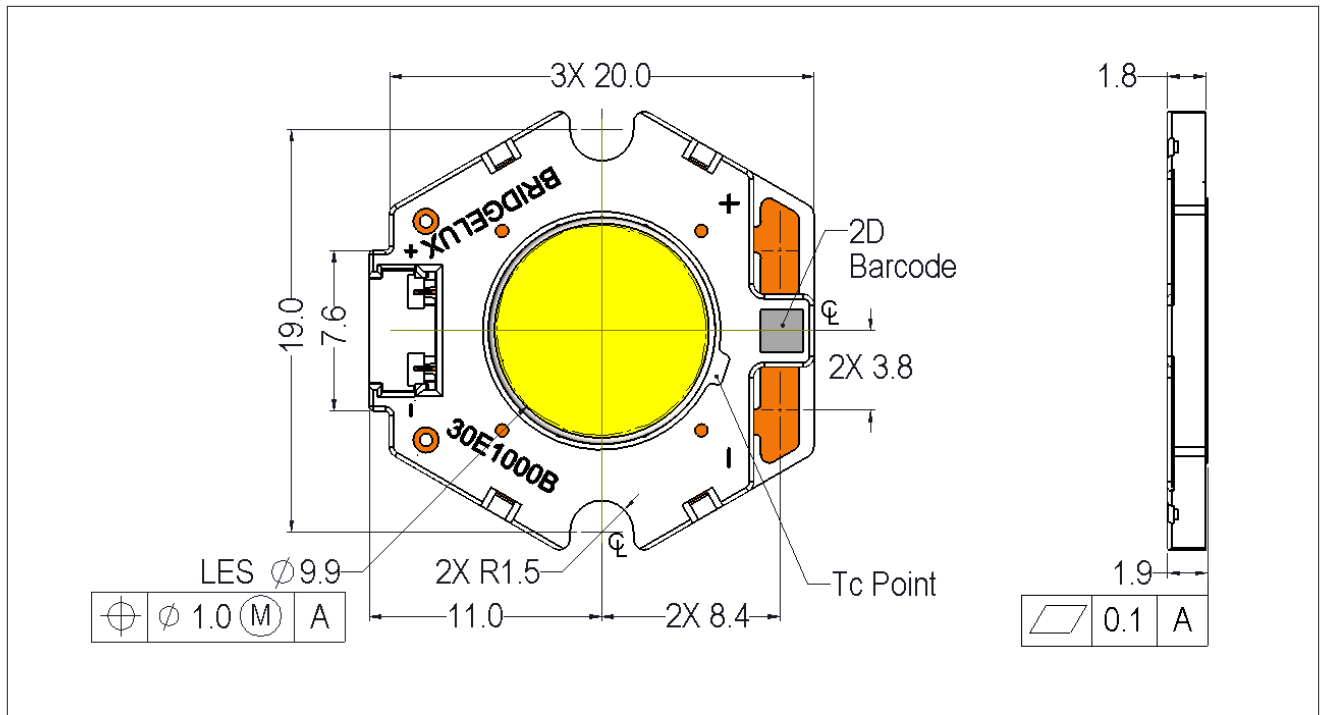

Table 6: CRI Spectra for Décor Ultra Products vs. Alternative Light Sources

Light Source	Ra	R1	R2	R3	R4	R5	R6	R7	R8	R9	R10	R11	R12	R13	R14	R15
Bridgelux Décor Ultra	97	97	100	96	96	98	98	99	98	98	99	92	87	98	97	98
Typical Halogen	98	98	99	99	99	98	98	99	97	92	97	98	97	98	99	97
Typical Metal Halide	82	90	94	69	82	81	81	87	71	27	59	62	55	93	78	88
Typical Compact Fluorescent	87	91	93	86	91	89	90	88	70	17	76	91	81	93	92	81

Mechanical Dimensions

Figure 23: Drawing for Vero 10 LED Array



Notes for Figure 23:

1. Drawings are not to scale.
2. Drawing dimensions are in millimeters.
3. Unless otherwise specified, tolerances are $\pm 0.10\text{mm}$.
4. Mounting slots (2X) are for M2.5 screws.
5. Bridgelux recommends two tapped holes for mounting screws with $19.0 \pm 0.10\text{mm}$ center-to-center spacing.
6. Screws with flat shoulders (pan, dome, button, round, truss, mushroom) provide optimal torque control. Do NOT use flat, countersink, or raised head screws.
7. Solder pads and connector port are labeled "+" and "-" to denote positive and negative, respectively.
8. It is not necessary to provide electrical connections to both the solder pads and the connector port. Either set may be used depending on application specific design requirements.
9. Refer to Application Notes AN30 and AN31 for product handling, mounting and heat sink recommendations.
10. The optical center of the LED Array is nominally defined by the mechanical center of the array to a tolerance of $\pm 0.2\text{mm}$.
11. Bridgelux maintains a flatness of 0.10mm across the mounting surface of the array.

Mechanical Dimensions

Figure 24: Drawing for Vero 13 LED Array

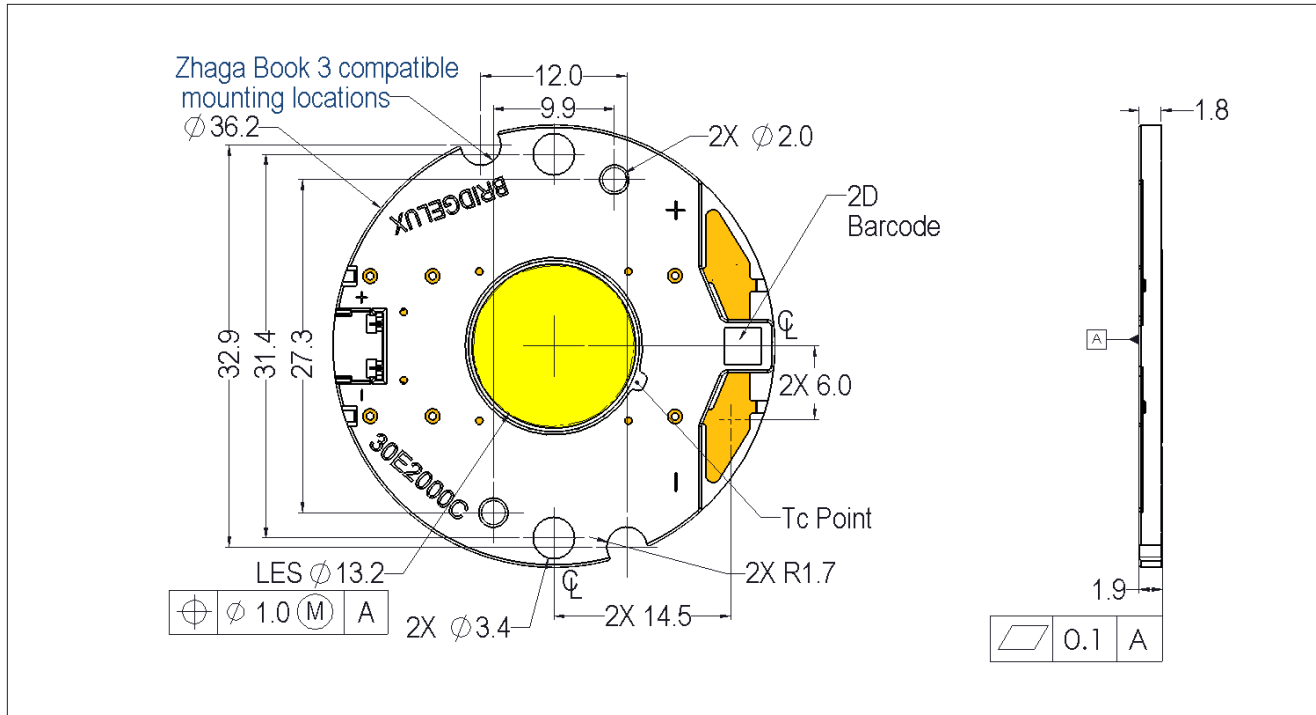

Notes for Figure 24:

1. Drawings are not to scale.
2. Drawing dimensions are in millimeters.
3. Unless otherwise specified, tolerances are $\pm 0.10\text{mm}$.
4. Mounting holes (2X) are for M2.5 screws.
5. Bridgelux recommends two tapped holes for mounting screws with $31.4 \pm 0.10\text{mm}$ center-to-center spacing.
6. Screws with flat shoulders (pan, dome, button, round, truss, mushroom) provide optimal torque control. Do NOT use flat, countersink, or raised head screws.
7. Solder pads and connector port are labeled "+" and "-" to denote positive and negative, respectively.
8. It is not necessary to provide electrical connections to both the solder pads and the connector port. Either set may be used depending on application specific design requirements.
9. Refer to Application Notes AN30 and AN31 for product handling, mounting and heat sink recommendations.
10. The optical center of the LED Array is nominally defined by the mechanical center of the array to a tolerance of $\pm 0.2\text{mm}$.
11. Bridgelux maintains a flatness of 0.10mm across the mounting surface of the array.

Mechanical Dimensions

Figure 25: Drawing for Vero 18 LED Array

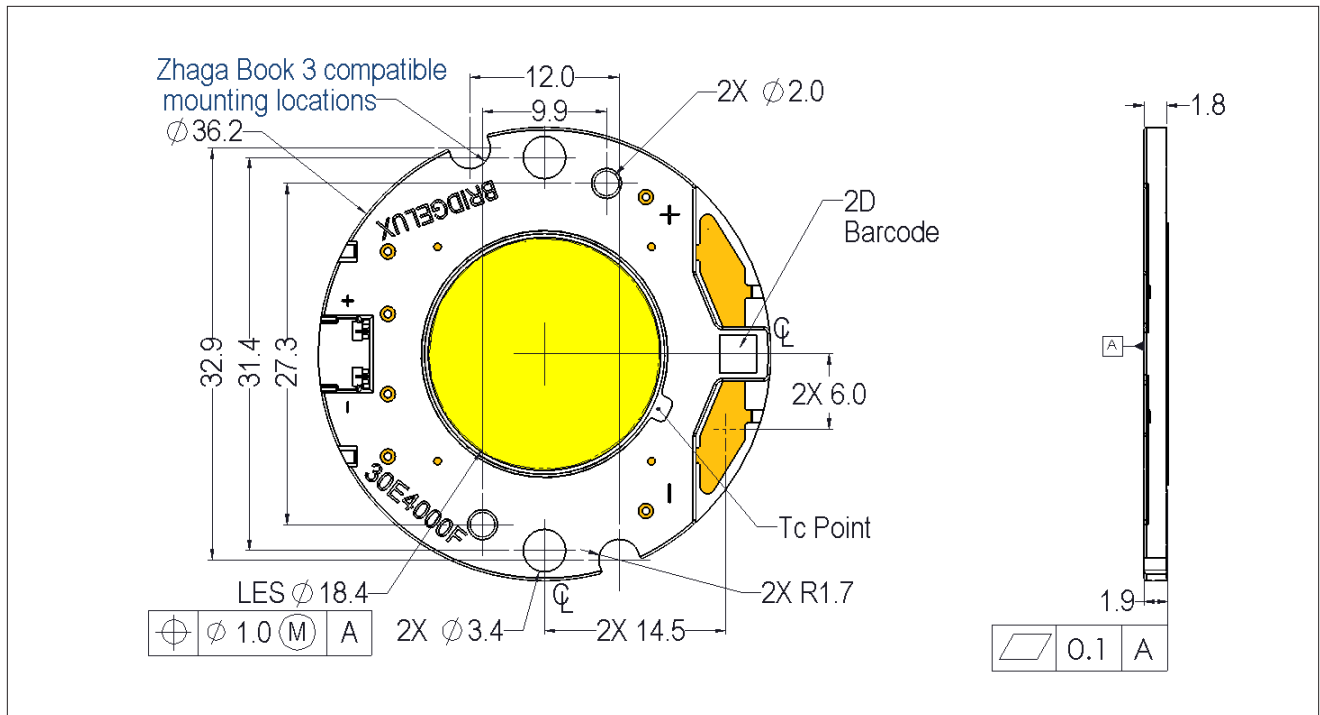

Notes for Figure 25:

1. Drawings are not to scale.
2. Drawing dimensions are in millimeters.
3. Unless otherwise specified, tolerances are $\pm 0.10\text{mm}$.
4. Mounting holes (2X) are for M2.5 screws.
5. Bridgelux recommends two tapped holes for mounting screws with $31.4 \pm 0.10\text{mm}$ center-to-center spacing.
6. Screws with flat shoulders (pan, dome, button, round, truss, mushroom) provide optimal torque control. Do NOT use flat, countersink, or raised head screws.
7. Solder pads and connector port are labeled "+" and "-" to denote positive and negative, respectively.
8. It is not necessary to provide electrical connections to both the solder pads and the connector port. Either set may be used depending on application specific design requirements.
9. Refer to Application Notes AN30 and AN31 for product handling, mounting and heat sink recommendations.
10. The optical center of the LED Array is nominally defined by the mechanical center of the array to a tolerance of $\pm 0.2\text{mm}$.
11. Bridgelux maintains a flatness of 0.10mm across the mounting surface of the array.

Mechanical Dimensions

Figure 26: Drawing for Vero 29 LED Array

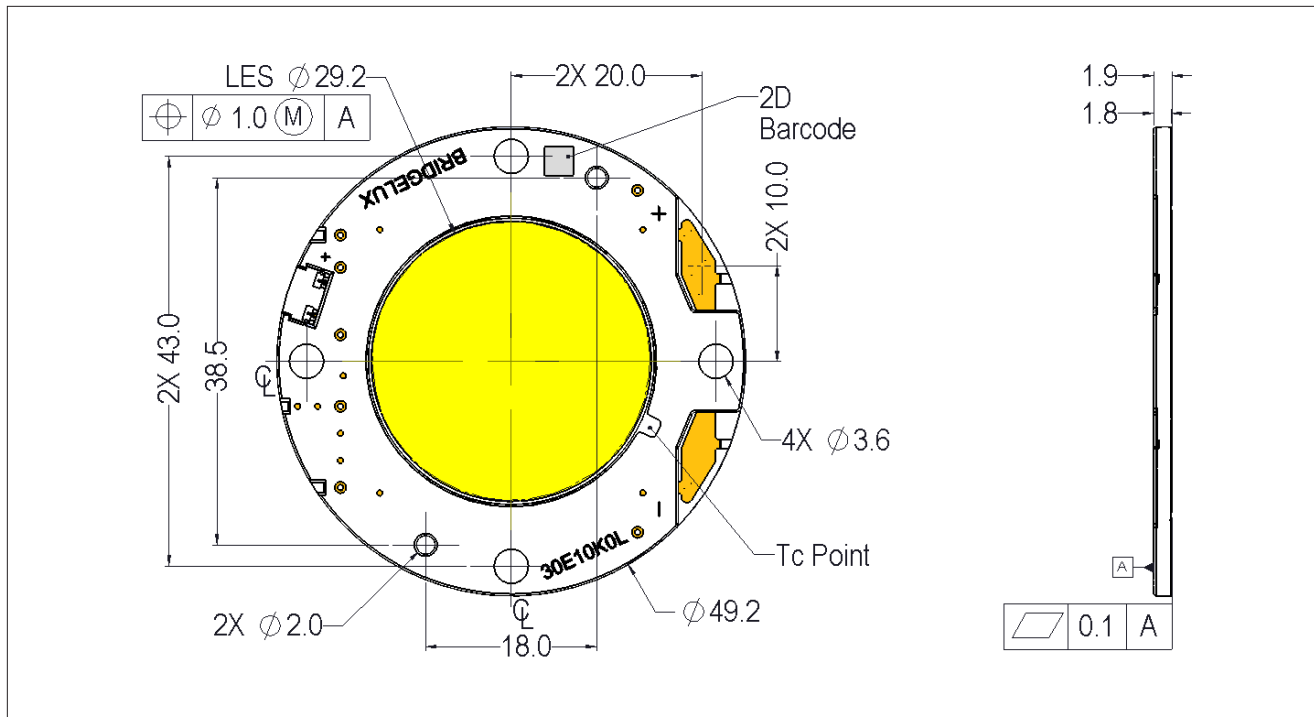

Notes for Figure 26:

1. Drawings are not to scale.
2. Drawing dimensions are in millimeters.
3. Unless otherwise specified, tolerances are $\pm 0.10\text{mm}$.
4. Mounting holes (2X) are for M3 screws.
5. Bridgelux recommends two tapped holes for mounting screws with $43.0 \pm 0.10\text{mm}$ center-to-center spacing.
6. Screws with flat shoulders (pan, dome, button, round, truss, mushroom) provide optimal torque control. Do NOT use flat, countersink, or raised head screws.
7. Solder pads and connector port are labeled "+" and "-" to denote positive and negative, respectively.
8. It is not necessary to provide electrical connections to both the solder pads and the connector port. Either set may be used depending on application specific design requirements.
9. Refer to Application Notes AN30 and AN31 for product handling, mounting and heat sink recommendations.
10. The optical center of the LED Array is nominally defined by the mechanical center of the array to a tolerance of $\pm 0.2\text{mm}$.
11. Bridgelux maintains a flatness of 0.10mm across the mounting surface of the array.

Color Binning Information

Figure 27: Graph of Warm and Neutral White Test Bins in xy Color Space

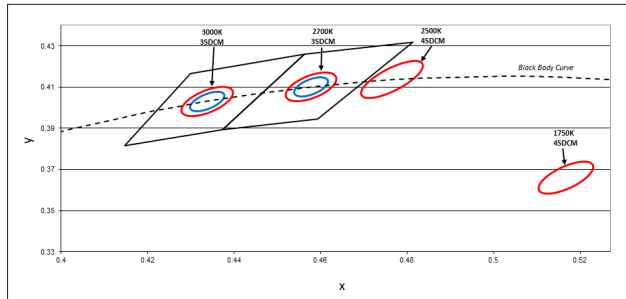

Note: Pulsed Test Conditions, $T_c = 25^\circ\text{C}$

Table 7: Warm White xy Bin Coordinates and Associated Typical CCT

Bin Code	1750K	2500K	2700K	3000K
ANSI Bin (for reference only)	-	-	(2580K - 2870K)	(2870K - 3220K)
23 (3SDCM)	-	-	(2651K - 2794K)	(2968K - 3136K)
22 (2SDCM)	-	-	(2674K - 2769K)	(2995K - 3107K)
Center Point (x,y)	(0.5167, 0.336)	(0.4765, 0.4137)	(0.4578, 0.4101)	(0.4338, 0.403)

Figure 28: Graph of Cool White Test Bins in xy Color Space

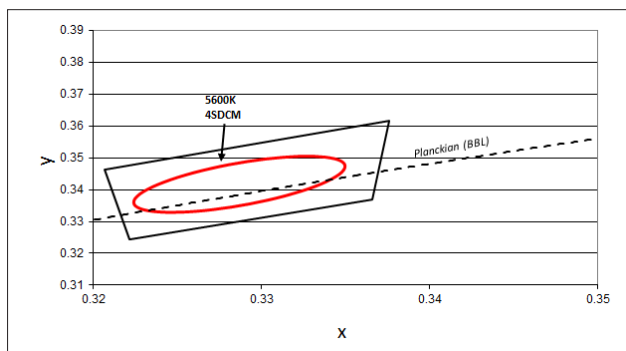

Note: Pulsed Test Conditions, $T_c = 25^\circ\text{C}$

Table 8: Cool White xy Bin Coordinates and Associated Typical CCT

Bin Code	5600K
ANSI Bin (for reference only)	(5310K - 6020K)
24 (4SDCM)	(5475K - 5830K)
Center Point (x,y)	(0.3293, 0.3423)

Packaging

Figure 29: Drawing for Vero 10 Packaging Tray

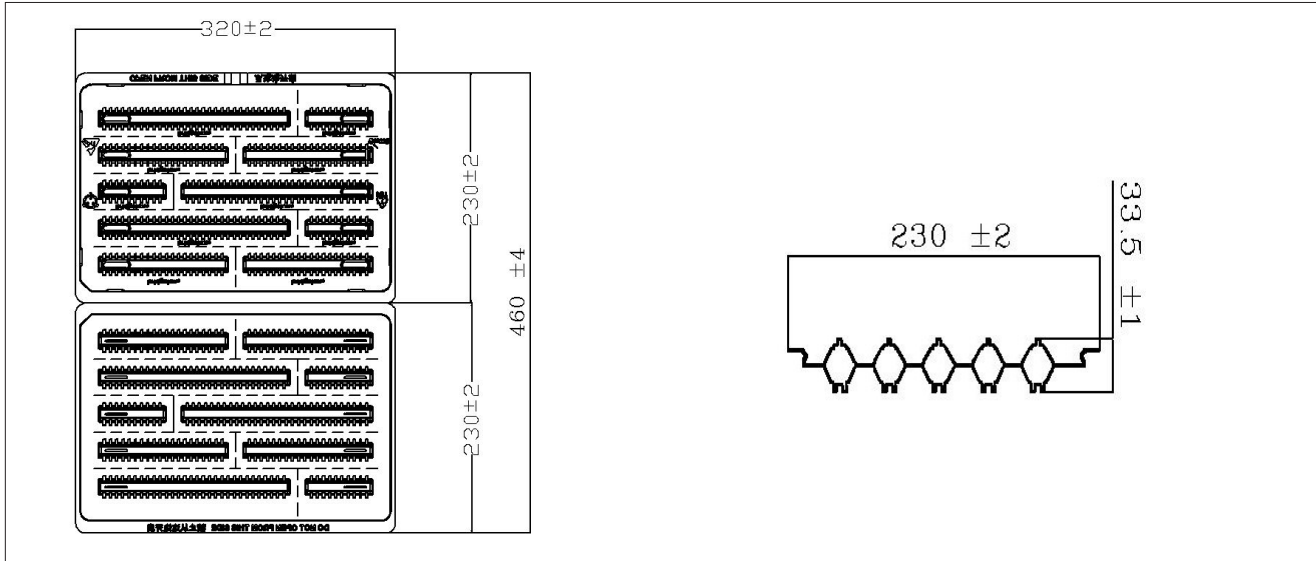

Notes for Figure 29:

1. Dimensions are in millimeters.
2. Drawing is not to scale.

Figure 30: Drawing for Vero 13 Packaging Tray

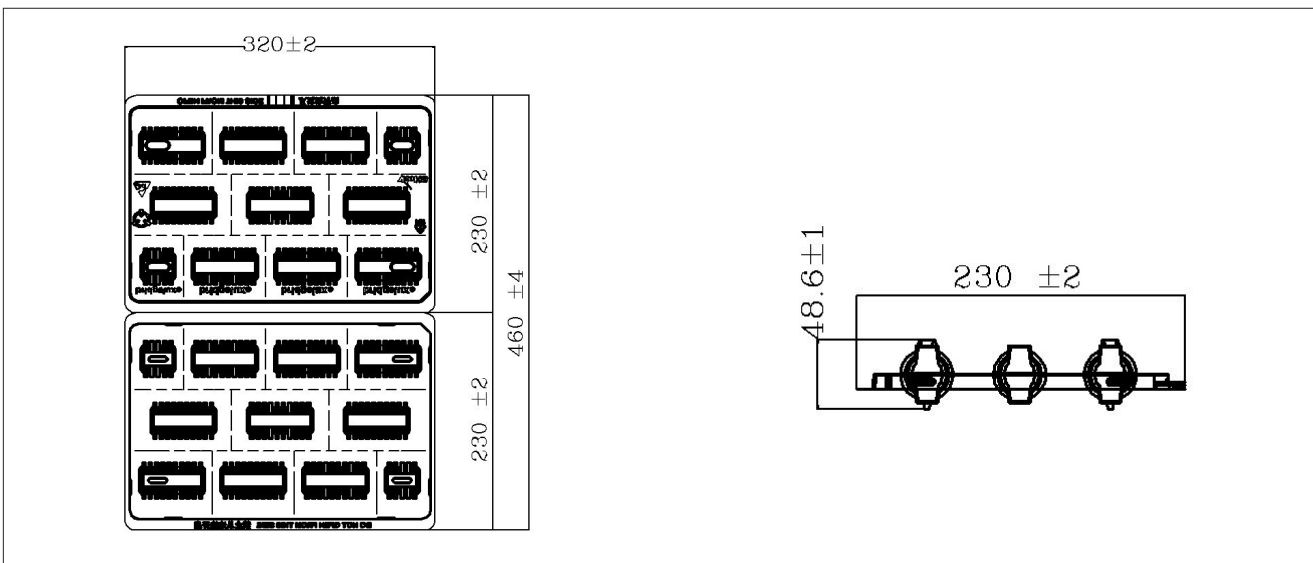

Notes for Figure 30:

1. Dimensions are in millimeters.
2. Drawing is not to scale.

Packaging

Figure 31: Drawing for Vero 18 Packaging Tray

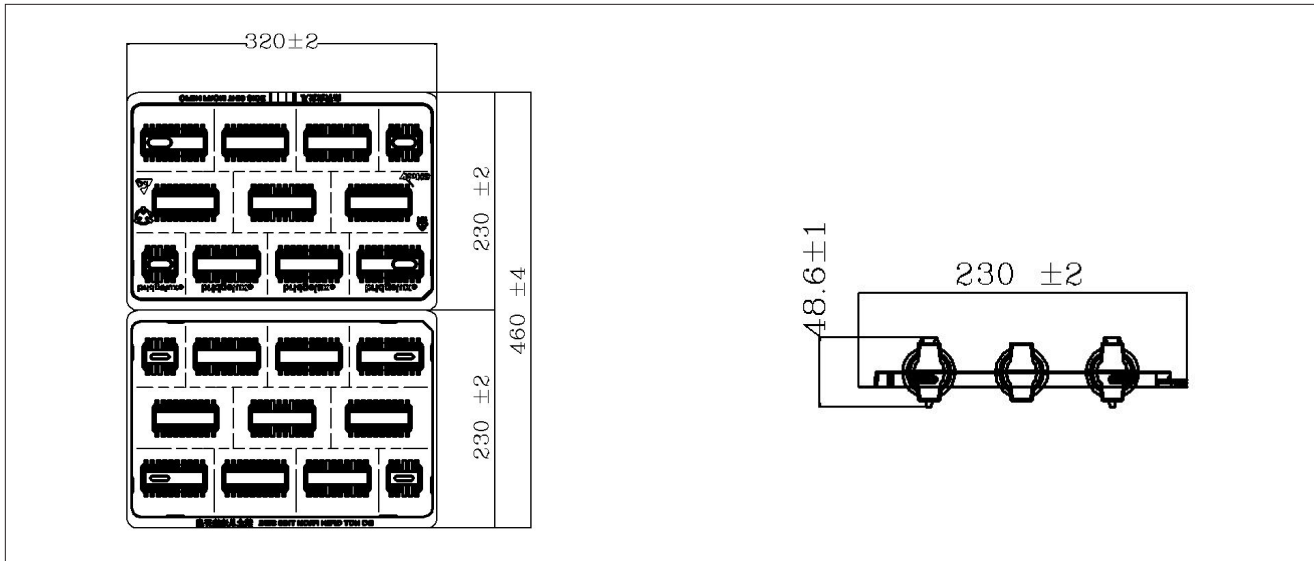

Notes for Figure 31:

1. Dimensions are in millimeters.
2. Drawings are not to scale.

Figure 32: Drawing for Vero 29 Packaging Tray

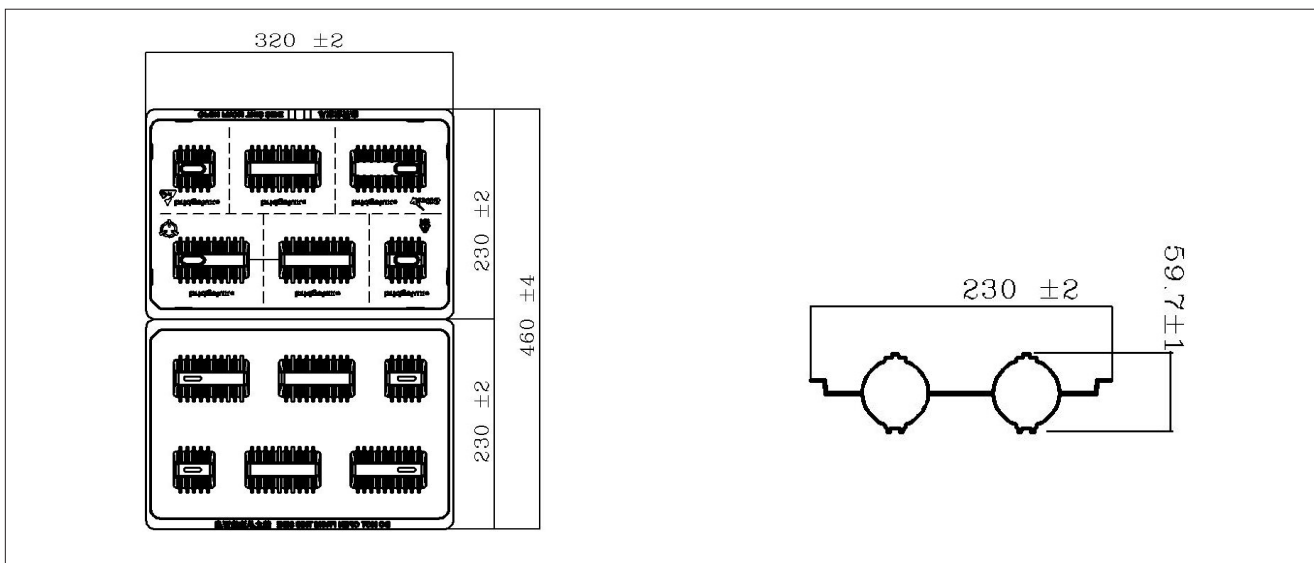

Notes for Figure 32:

1. Dimensions are in millimeters.
2. Drawings are not to scale.

Packaging

Figure 33: Vero Series Packaging and Labeling

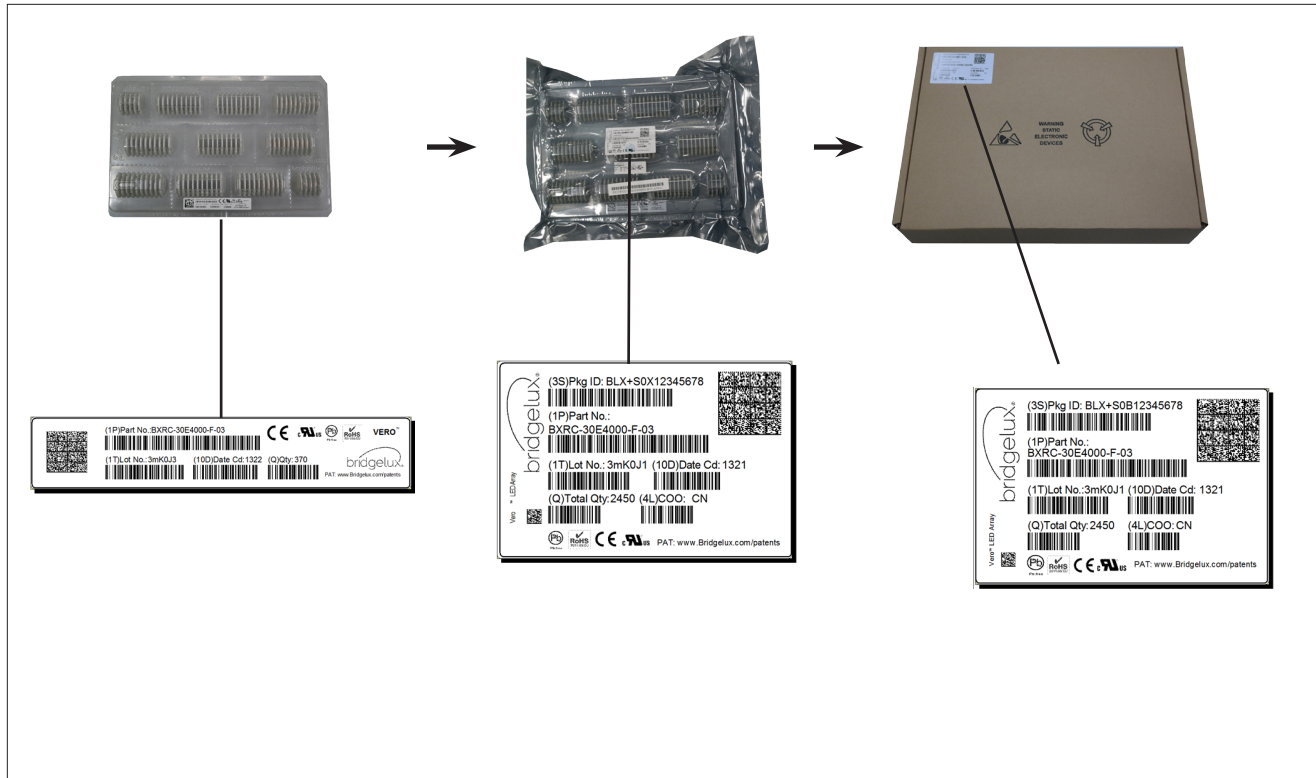

Notes for Figure 33:

1. Each tray holds for Vero 10: 200 COBs, Vero 13: 100 COBs, Vero 18: 100 COBs, Vero 29: 50 COBs.
2. Each tray is vacuum sealed in an anti-static bag and placed in its own box.
3. Each tray, bag and box is to be labeled as shown above.

Figure 34: Product Labeling

Bridgelux COB arrays have laser markings on the back side of the substrate to help with product identification. In addition to the product identification markings, Bridgelux COB arrays also contain markings for internal Bridgelux manufacturing use only. The image below shows which markings are for customer use and which ones are for Bridgelux internal use only. The Bridgelux internal manufacturing markings are subject to change without notice, however these will not impact the form, function or performance of the COB array.



Design Resources

Application Notes

Bridgelux has developed a comprehensive set of application notes and design resources to assist customers in successfully designing with the Vero product family of LED array products. For all available application notes visit www.bridgelux.com.

Optical Source Models

Optical source models and ray set files are available for all Bridgelux products. For a list of available formats, visit www.bridgelux.com.

3D CAD Models

Three dimensional CAD models depicting the product outline of all Bridgelux Vero LED arrays are available in both IGS and STEP formats. Please contact your Bridgelux sales representative for assistance.

Precautions

CAUTION: CHEMICAL EXPOSURE HAZARD

Exposure to some chemicals commonly used in luminaire manufacturing and assembly can cause damage to the LED array. Please consult Bridgelux Application Note AN31 for additional information.

CAUTION: EYE SAFETY

Eye safety classification for the use of Bridgelux Vero LED arrays is in accordance with IEC specification EN62471: Photobiological Safety of Lamps and Lamp Systems. Vero LED arrays are classified as Risk Group 1 (Low Risk) when operated at or below the maximum drive current. Please use appropriate precautions. It is important that employees working with LEDs are trained to use them safely.

CAUTION: RISK OF BURN

Do not touch the Vero LED array during operation. Allow the array to cool for a sufficient period of time before handling. The Vero LED array may reach elevated temperatures such that could burn skin when touched.

CAUTION

CONTACT WITH LIGHT EMITTING SURFACE (LES)

Avoid any contact with the LES. Do not touch the LES of the LED array or apply stress to the LES (yellow phosphor resin area). Contact may cause damage to the LED array.

Optics and reflectors must not be mounted in contact with the LES (yellow phosphor resin area). Optical devices may be mounted on the top surface of the plastic housing of the Vero LED array. Use the mechanical features of the LED array housing, edges and/or mounting holes to locate and secure optical devices as needed.

Disclaimers

MINOR PRODUCT CHANGE POLICY

The rigorous qualification testing on products offered by Bridgelux provides performance assurance. Slight cosmetic changes that do not affect form, fit, or function may occur as Bridgelux continues product optimization.

STANDARD TEST CONDITIONS

Unless otherwise stated, array testing is performed at the nominal drive current.

About Bridgelux: We Build Light That Transforms

At Bridgelux, we help companies, industries and people experience the power and possibility of light. Since 2002, we've designed LED solutions that are high performing, energy efficient, cost effective and easy to integrate. Our focus is on light's impact on human behavior, delivering products that create better environments, experiences and returns—both experiential and financial. And our patented technology drives new platforms for commercial and industrial luminaires.

For more information about the company, please visit
bridgelux.com
twitter.com/Bridgelux
facebook.com/Bridgelux
WeChat ID: BridgeluxInChina



101 Portola Avenue
Livermore, CA 94551
Tel (925) 583-8400
Fax (925) 583-8410
www.bridgelux.com

© 2016 Bridgelux, Inc. All rights reserved 2016. Product specifications are subject to change without notice. Bridgelux, the Bridgelux stylized logo design and Vero are registered trademarks, and Decor Series is a trademark of Bridgelux, Inc. All other trademarks are the property of their respective owners.

Bridgelux Vero Decor Series Product Data Sheet DS34 Rev. C (03/2016)