

## SUMMARY



*Image is for illustrative purpose only*

### # Wires

Low	0
High	0
Coax	0
Triax	0
Quad	0
Fiber	0
Fluidic	0

### Download

[Request a quote](#)

[Catalog](#)

Series	1K
Termination type	No contacts / Accessory
IP rating	68
Cable Ø	0.00 - 0.00 mm
Matching parts	
Status	active
Alternative part	

## TECHNICAL DETAILS

### Mechanics

Shell Style/Model	BRE*: Cap for receptacle
Keying	No keying
Housing Material	Brass (nickel plated) shell, collet nut, latch sleeve and mid pieces
Cable Fixing	∅ 0 - 0 mm
Variant	
Weight	17.32 g

### Performance

Configuration
Insulator
Rated Current

### Others

LEMO products and services are provided "as is". LEMO makes no warranties or representations with regard to LEMO product & services or use of them, express, implied or statutory, including for accuracy, completeness, or security. The user is fully responsible for his products and applications using LEMO components.

Endurance (Shell): 5000 mating cycles  
 Temp (min / max): -55°C / +200°C  
 Humidity (max): <=95% [at 60 deg C / 140 F]  
 Vibration: 15 g [10 Hz - 2000 Hz]  
 Shock Resistance: 100 g [ 6 ms]  
 Salt Spray Corrosion: >1000 hr  
 Climatological Category: 50/175/21  
 Shielding (min): 95 dB (10 MHz)  
 Shielding (min): 80 dB (1 GHz)  
 IP Rating: 68

## DRAWINGS

### Draws

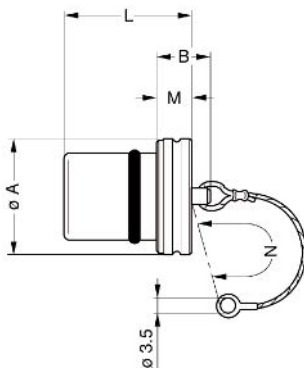

No keying

### Dimensions

	A	B	L	M	N
mm.	17	12	20	6	85
in.	0,67	0,47	0,79	0,24	3,35

## RECOMMENDED BY LEMO

### Tools

None

### Cables

LEMO products and services are provided "as is". LEMO makes no warranties or representations with regard to LEMO product & services or use of them, express, implied or statutory, including for accuracy, completeness, or security. The user is fully responsible for his products and applications using LEMO components.

121 221			
131 221			
151 221			
161 221			

*LEMO products and services are provided "as is". LEMO makes no warranties or representations with regard to LEMO product & services or use of them, express, implied or statutory, including for accuracy, completeness, or security. The user is fully responsible for his products and applications using LEMO components.*